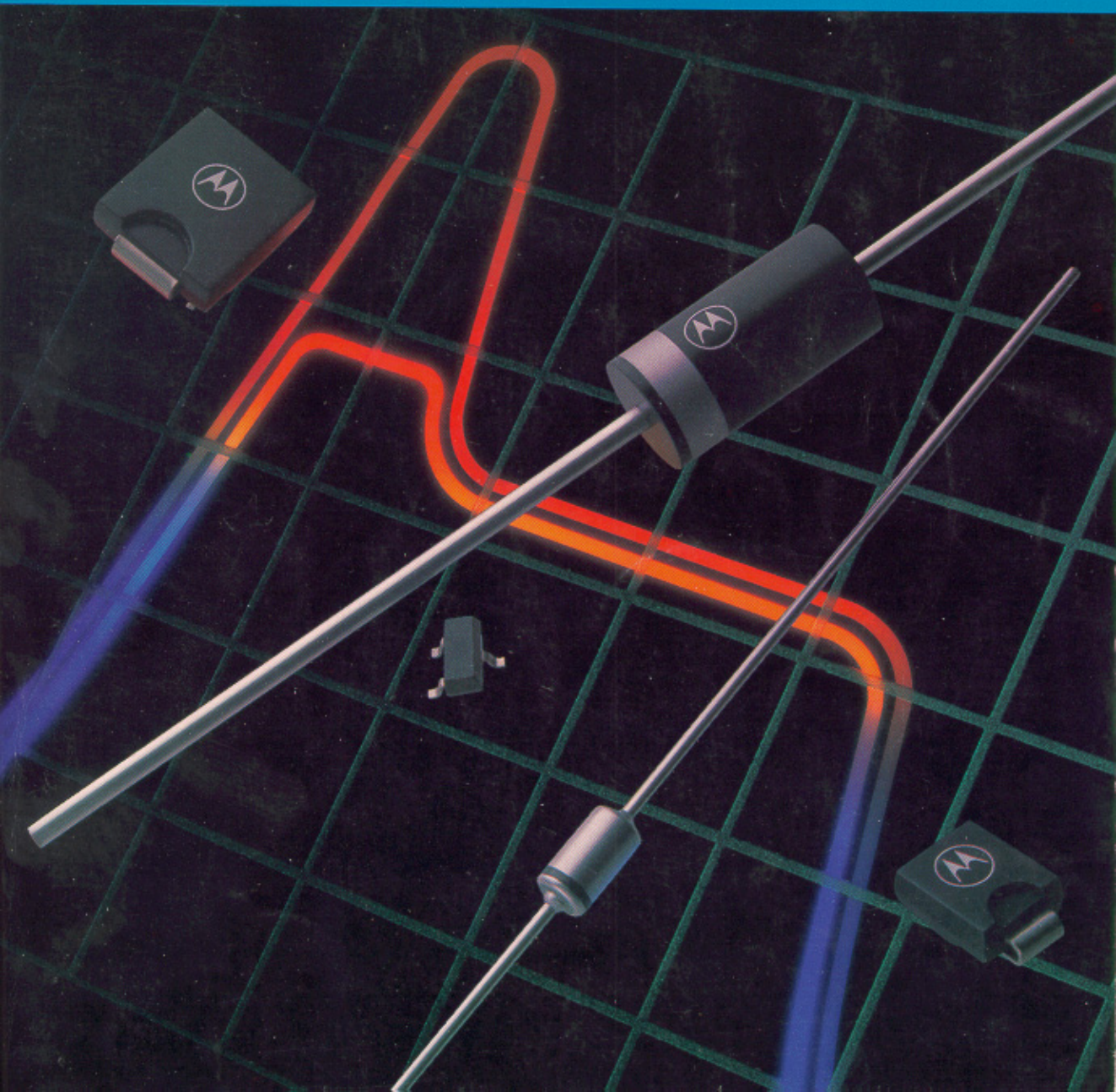


# TVS/Zener

## Device Data



<b>Alphanumeric Index of Part Numbers</b>	<b>1</b>
<b>Cross Reference and Index</b>	<b>2</b>
<b>Selector Guide for Transient Voltage Suppressors and Zener Diodes</b>	<b>3</b>
<b>Transient Voltage Suppressors Axial Leaded Data Sheets</b>	<b>4</b>
<b>Transient Voltage Suppressors Surface Mounted Data Sheets</b>	<b>5</b>
<b>Zener Voltage Regulator Diodes Axial Leaded Data Sheets</b>	<b>6</b>
<b>Zener Voltage Regulator Diodes Surface Mounted Data Sheets</b>	<b>7</b>
<b>Zener Voltage Reference Diodes Data Sheets</b>	<b>8</b>
<b>Current Regulator Diodes Data Sheets</b>	<b>9</b>
<b>Surface Mount Information and Packaging Specifications</b>	<b>10</b>
<b>Technical Information, Application Notes and Articles</b>	<b>11</b>

Designer's, Surmetic and MOSORB are trademarks of Motorola, Inc.  
Thermal Clad is a trademark of the Bergquist Company.




# TVS/Zeners Device Data

---

This book presents technical data for the broad line of Motorola Transient Voltage Suppressors and Zener Diodes. Complete specifications for the individual devices are provided in the form of data sheets. A comprehensive Selector Guide and Industry Cross Reference Guide are included to simplify the task of choosing the best set of components required for a specific application.

Finally, to assist the circuit designer the popular Motorola Zener Diode Handbook and related application notes and technical articles have been added to make this a more complete reference book.

Motorola reserves the right to make changes without further notice to any products herein to improve reliability, function or design. Motorola does not assume any liability arising out of the application or use of any product or circuit described herein; neither does it convey any license under its patent rights nor the rights of others. Motorola products are not designed, intended, or authorized for use as components in systems intended for surgical implant into the body, or other applications intended to support or sustain life, or for any other application in which the failure of the Motorola product could create a situation where personal injury or death may occur. Should Buyer purchase or use Motorola products for any such unintended or unauthorized application, Buyer shall indemnify and hold Motorola and its officers, employees, subsidiaries, affiliates, and distributors harmless against all claims, costs, damages, and expenses, and reasonable attorney fees arising out of, directly or indirectly, any claim of personal injury or death associated with such unintended or unauthorized use, even if such claim alleges that Motorola was negligent regarding the design or manufacture of the part. Motorola and  are registered trademarks of Motorola, Inc. Motorola, Inc. is an Equal Opportunity/Affirmative Action Employer.

© Motorola, Inc. 1994  
2nd Edition  
"All Rights Reserved"

# TABLE OF CONTENTS

## SECTION ONE — Alphanumeric Index of Part Numbers

Alphanumeric Index of Part Numbers ..... 1-2

## SECTION TWO — Cross Reference and Index

Cross Reference and Index ..... 2-1

## SECTION THREE — Selector Guide for Transient Voltage Suppressors and Zener Diodes

<b>TVS (Transient Voltage Suppressors)</b> .....	3-2
General-Purpose .....	3-2
Axial Leaded for Through-hole Designs .....	3-2
Surface Mount Packages .....	NO TAG
Overvoltage Transient Suppressors .....	NO TAG
<b>Zener Diodes</b> .....	NO TAG
Voltage Regulator Diodes .....	NO TAG
Axial Leaded for Through-hole Designs	
500 mW .....	NO TAG
Axial Leaded for Through-hole Designs	
1, 1.3, 1.5, 3 and 5 Watt .....	NO TAG
Surface Mount Packages .....	NO TAG
Voltage Reference Diodes .....	NO TAG
Temperature Compensated Reference	
Devices .....	NO TAG
Current Regulator Diodes .....	NO TAG

## SECTION FOUR — Transient Voltage Suppressors — Axial Leaded Data Sheets

<b>500 Watt Peak Power</b>	
SA5.0A through SA170A .....	4-2
<b>600 Watt Peak Power</b>	
P6KE6.8A through P6KE200A .....	NO TAG
<b>1500 Watt Peak Power</b>	
General Data — 1500 Watt .....	NO TAG
1N5908 .....	NO TAG
1N6267A through 1N6303A, 1.5KE6.8A through	
1.5KE250A .....	NO TAG
1N6373 through 1N6389, ICTE-5 through	
ICTE-45C and MPTE-5 through MPTE-45C .....	NO TAG
<b>Overvoltage 110 Amp Repetitive Peak</b>	
MR2535L .....	NO TAG

## SECTION FIVE — Transient Voltage Suppressors — Surface Mounted Data Sheets

<b>24 Watt Peak Power</b>	
MMBZ5V6ALT1 .....	5-2
<b>40 Watt Peak Power</b>	
MMBZ15VDLT1 .....	NO TAG
<b>600 Watt Peak Power</b>	
General Data — 600 Watt .....	NO TAG
1SMB5.0AT3 through 1SMB170AT3 .....	NO TAG
1SMB10CAT3 through 1SMB78AT3 .....	NO TAG
P6SMB6.8AT3 through P6SMB200AT3 .....	NO TAG
P6SMB11CAT3 through P6SMB91CAT3 .....	NO TAG

## 1500 Watt Peak Power

General Data — 1500 Watt .....	NO TAG
1SMC5.0AT3 through 1SMC78AT3 .....	NO TAG
1.5SMC6.8AT3 through 1.5SMC91AT3 .....	NO TAG

## SECTION SIX — Zener Voltage Regulator Diodes — Axial Leaded Data Sheets

### 500 mW DO-35 Glass

General Data .....	6-2
1N4370 through 1N4372A, 1N746A through	
1N759A and 1N957B through 1N992B .....	NO TAG
1N4678 through 1N4717 .....	NO TAG
1N5221B through 1N5281B .....	NO TAG
1N5985B through 1N6025B .....	NO TAG
BZX55C2V4RL through BZX55C91RL .....	NO TAG
BZX79C2V4RL through BZX79C200RL .....	NO TAG
BZX83C2V7RL through BZX83C33RL and	
ZPD2.7RL through ZPD33RL .....	NO TAG
MZ4614 through MZ4627 .....	NO TAG
MZ5520B through MZ5530B .....	NO TAG

### 1–1.3 Watt DO-41 Glass

General Data .....	NO TAG
1N4728A through 1N4764A .....	NO TAG
BZX85C3V3RL through BZX85C100RL .....	NO TAG
MZPY3.9RL through MZPY100RL .....	NO TAG

### 1–3 Watt DO-41 Surmetic 30

General Data .....	NO TAG
1N5913B through 1N5956B .....	NO TAG
3EZ3.9D5 through 3EZ400D5 .....	NO TAG
MZD3.9 through MZD200 .....	NO TAG
MZP4728A through MZP4764A,	
1M110ZS5 through 1M200ZS5 .....	NO TAG

### 5 Watt Surmetic 40

1N5333B through 1N5388B .....	6-38
-------------------------------	------

## SECTION SEVEN — Zener Voltage Regulator Diodes — Surface Mounted Data Sheets

### 225 mW (SOT-23)

General Data .....	7-2
BZX84C2V4LT1 through BZX84C75LT1 .....	NO TAG
MMBZ5221BLT1 through MMBZ5270BLT1 .....	NO TAG

### 500 mW (SOD-123)

General Data .....	7-8
MMSZ5221BT1 through MMSZ5270BT1 .....	7-8
MMSZ4678T1 through MMSZ4717T1 .....	NO TAG
MMSZ2V4T1 through MMSZ75T1 .....	NO TAG

### 3 Watt DC Power

General Data .....	7-17
1SMB5913BT3 through 1SMB5956BT3 .....	7-17

## SECTION EIGHT — Zener Voltage Reference Diodes — Data Sheets

### 6.2 Volt OTC 400 mW DO-35

1N821,A 1N823,A 1N825,A	
1N827,A 1N829,A .....	8-2

## Table of Contents (continued)

### SECTION NINE — Current Regulator Diodes — Axial Leaded Data Sheets

#### 1.5 Watt DC Power

General Data .....	9-2
1N5283 through 1N5314 .....	9-2

### SECTION TEN — Surface Mount Information and Packaging Specifications

TVS/Zener Axial Lead .....	10-2
TVS/Zener Surface Mount .....	10-4

### SECTION ELEVEN — Technical Information, Application Notes and Articles

#### CHAPTER 1

Zener Diode Theory .....	11-2
--------------------------	------

#### CHAPTER 2

Zener Diode Fabrication Techniques .....	11-7
--	------

#### CHAPTER 3

Reliability .....	11-11
-------------------	-------

#### CHAPTER 4

Zener Diode Characteristics .....	11-17
-----------------------------------	-------

#### CHAPTER 5

Temperature Compensated Zeners .....	11-29
--------------------------------------	-------

#### CHAPTER 6

Basic Voltage Regulation Using Zener Diodes .....	11-33
--	-------

#### CHAPTER 7

Zener Protection Circuits and Techniques: Basic Design Considerations .....	11-43
--	-------

#### CHAPTER 8

Zener Voltage Sensing Circuits and Applications .....	11-53
--	-------

#### CHAPTER 9

Miscellaneous Applications of Zener Type Devices .....	11-60
---	-------

#### CHAPTER 10

Transient Voltage Suppression .....	11-62
-------------------------------------	-------

#### CHAPTER 11

Application Notes .....	11-81
AN784 — Transient Power Capability of Zener Diodes .....	11-81
AN843 — A Review of Transients and Their Means of Suppression .....	11-83
Design Considerations and Performance of Motorola Temperature-Compensated Zener (Reference) Diodes .....	11-96

#### CHAPTER 12

Articles .....	11-101
Some Straight Talk About Mosorbs Transient Voltage Suppressors .....	11-101
AR450 — Characterizing Overvoltage Transient Suppressors .....	11-105
Measurement of Zener Voltage to Thermal Equilibrium with Pulsed Test Circuit .....	11-118

**For:colleen**

**Printed on:Tue, Jun 30, 1998 16:02:50**

**From book:DL150\_SEC1 (2) VIEW**

**Document:DL150\_SEC1\_TOC VIEW**

**Last saved on:Tue, Jun 30, 1998 15:43:37**

**Document:DL150\_INDX VIEW**

**Last saved on:Tue, Jun 30, 1998 15:43:39**

# Section One

1

## Alphanumeric Index of Part Numbers



# ALPHANUMERIC INDEX

DEVICE	PAGE
1.5KE100A	4-17
1.5KE100CA	4-17
1.5KE10A	4-17
1.5KE10CA	4-17
1.5KE110A	4-17
1.5KE110CA	4-17
1.5KE11A	4-17
1.5KE11CA	4-17
1.5KE120CA	4-17
1.5KE12A	4-17
1.5KE12CA	4-17
1.5KE130A	4-17
1.5KE130CA	4-17
1.5KE13A	4-17
1.5KE13CA	4-17
1.5KE150A	4-17
1.5KE150CA	4-17
1.5KE15CA	4-17
1.5KE15A	4-17
1.5KE160A	4-17
1.5KE160CA	4-17
1.5KE16A	4-17
1.5KE16CA	4-17
1.5KE170A	4-17
1.5KE180CA	4-17
1.5KE18A	4-17
1.5KE18CA	4-17
1.5KE200A	4-17
1.5KE200CA	4-17
1.5KE20A	4-17
1.5KE20CA	4-17
1.5KE220A	4-17
1.5KE220CA	4-17
1.5KE22A	4-17
1.5KE22CA	4-17
1.5KE24A	4-17
1.5KE24CA	4-17
1.5KE250A	4-17
1.5KE250CA	4-17
1.5KE27A	4-17
1.5KE27CA	4-17
1.5KE30A	4-17
1.5KE30CA	4-17
1.5KE33A	4-17
1.5KE33CA	4-17
1.5KE36A	4-17
1.5KE36CA	4-17
1.5KE39A	4-17
1.5KE39CA	4-17
1.5KE43A	4-17
1.5KE43CA	4-17
1.5KE47A	4-17
1.5KE47CA	4-17
1.5KE51A	4-17

DEVICE	PAGE
1.5KE51CA	4-17
1.5KE56A	4-17
1.5KE56CA	4-17
1.5KE6.8A	4-17
1.5KE6.8CA	4-17
1.5KE62CA	4-17
1.5KE68A	4-17
1.5KE68CA	4-17
1.5KE7.5A	4-17
1.5KE7.5CA	4-17
1.5KE75A	4-17
1.5KE75CA	4-17
1.5KE8.2A	4-17
1.5KE8.2CA	4-17
1.5KE82A	4-17
1.5KE82CA	4-17
1.5KE9.1A	4-17
1.5KE9.1CA	4-17
1.5KE91A	4-17
1.5KE91CA	4-17
1.5SMC10AT3	5-23
1.5SMC11AT3	5-23
1.5SMC12AT3	5-23
1.5SMC13AT3	5-23
1.5SMC15AT3	5-23
1.5SMC16AT3	5-23
1.5SMC18AT3	5-23
1.5SMC20AT3	5-23
1.5SMC22AT3	5-23
1.5SMC24AT3	5-23
1.5SMC27AT3	5-23
1.5SMC30AT3	5-23
1.5SMC33AT3	5-23
1.5SMC36AT3	5-23
1.5SMC39AT3	5-23
1.5SMC43AT3	5-23
1.5SMC47AT3	5-23
1.5SMC51AT3	5-23
1.5SMC56AT3	5-23
1.5SMC6.8AT3	5-23
1.5SMC62AT3	5-23
1.5SMC68AT3	5-23
1.5SMC7.5AT3	5-23
1.5SMC75AT3	5-23
1.5SMC8.2AT3	5-23
1.5SMC82AT3	5-23
1.5SMC9.1AT3	5-23
1.5SMC91AT3	5-23
11.5KE120A	4-17
11.5KE170CA	4-17
11.5KE180A	4-17
11.5KE62A	4-17
1M110ZS5	6-36
1M120ZS5	6-36

DEVICE	PAGE
1M130ZS5	6-36
1M150ZS5	6-36
1M160ZS5	6-36
1M180ZS5	6-36
1M200ZS5	6-36
1N4370A	6-8
1N4371A	6-8
1N4372A	6-8
1N4678	6-10
1N4679	6-10
1N4680	6-10
1N4681	6-10
1N4682	6-10
1N4683	6-10
1N4684	6-10
1N4685	6-10
1N4686	6-10
1N4687	6-10
1N4688	6-10
1N4689	6-10
1N4690	6-10
1N4691	6-10
1N4692	6-10
1N4693	6-10
1N4694	6-10
1N4695	6-10
1N4696	6-10
1N4697	6-10
1N4698	6-10
1N4699	6-10
1N4700	6-10
1N4701	6-10
1N4702	6-10
1N4703	6-10
1N4704	6-10
1N4705	6-10
1N4706	6-10
1N4707	6-10
1N4708	6-10
1N4709	6-10
1N4710	6-10
1N4711	6-10
1N4712	6-10
1N4713	6-10
1N4714	6-10
1N4715	6-10
1N4716	6-10
1N4717	6-10
1N4728A	6-24
1N4729A	6-24
1N4730A	6-24
1N4731A	6-24
1N4732A	6-24
1N4733A	6-24

## ALPHANUMERIC INDEX (continued)

DEVICE	PAGE	DEVICE	PAGE	DEVICE	PAGE
1N4734A	6-24	1N5244B	6-11	1N5299	9-3
1N4735A	6-24	1N5245B	6-11	1N5300	9-3
1N4736A	6-24	1N5246B	6-11	1N5301	9-3
1N4737A	6-24	1N5247B	6-11	1N5302	9-3
1N4738A	6-24	1N5248B	6-11	1N5303	9-3
1N4739A	6-24	1N5249B	6-11	1N5304	9-3
1N4740A	6-24	1N5250B	6-11	1N5305	9-3
1N4741A	6-24	1N5251B	6-11	1N5306	9-3
1N4742A	6-24	1N5252B	6-11	1N5307	9-3
1N4743A	6-24	1N5253B	6-11	1N5308	9-3
1N4744A	6-24	1N5254B	6-11	1N5309	9-3
1N4745A	6-24	1N5255B	6-11	1N5310	9-3
1N4746A	6-24	1N5256B	6-11	1N5311	9-3
1N4747A	6-24	1N5257B	6-11	1N5312	9-3
1N4748A	6-24	1N5258B	6-11	1N5313	9-3
1N4749A	6-24	1N5259B	6-11	1N5314	9-3
1N4750A	6-24	1N5260B	6-11	1N5333B	6-39
1N4751A	6-24	1N5261B	6-11	1N5334B	6-39
1N4752A	6-24	1N5262B	6-11	1N5335B	6-39
1N4753A	6-24	1N5263B	6-11	1N5336B	6-39
1N4754A	6-24	1N5264B	6-11	1N5337B	6-39
1N4755A	6-24	1N5265B	6-11	1N5338B	6-39
1N4756A	6-24	1N5266B	6-12	1N5339B	6-39
1N4757A	6-24	1N5267B	6-12	1N5340B	6-39
1N4758A	6-24	1N5268B	6-12	1N5341B	6-39
1N4759A	6-24	1N5269B	6-12	1N5342B	6-39
1N4760A	6-24	1N5270B	6-12	1N5343B	6-39
1N4761A	6-24	1N5271B	6-12	1N5344B	6-39
1N4762A	6-24	1N5272B	6-12	1N5345B	6-39
1N4763A	6-24	1N5273B	6-12	1N5346B	6-39
1N4764A	6-24	1N5274B	6-12	1N5347B	6-39
1N5221B	6-11	1N5275B	6-12	1N5348B	6-39
1N5222B	6-11	1N5276B	6-12	1N5349B	6-39
1N5223B	6-11	1N5277B	6-12	1N5350B	6-39
1N5224B	6-11	1N5278B	6-12	1N5351B	6-39
1N5225B	6-11	1N5279B	6-12	1N5352B	6-39
1N5226B	6-11	1N5280B	6-12	1N5353B	6-39
1N5227B	6-11	1N5281B	6-12	1N5354B	6-39
1N5228B	6-11	1N5283	9-3	1N5355B	6-39
1N5229B	6-11	1N5284	9-3	1N5356B	6-39
1N5230B	6-11	1N5285	9-3	1N5357B	6-39
1N5231B	6-11	1N5286	9-3	1N5358B	6-39
1N5232B	6-11	1N5287	9-3	1N5359B	6-39
1N5233B	6-11	1N5288	9-3	1N5360B	6-39
1N5234B	6-11	1N5289	9-3	1N5361B	6-39
1N5235B	6-11	1N5290	9-3	1N5362B	6-39
1N5236B	6-11	1N5291	9-3	1N5363B	6-39
1N5237B	6-11	1N5292	9-3	1N5364B	6-39
1N5238B	6-11	1N5293	9-3	1N5365B	6-39
1N5239B	6-11	1N5294	9-3	1N5366B	6-39
1N5240B	6-11	1N5295	9-3	1N5367B	6-39
1N5241B	6-11	1N5296	9-3	1N5368B	6-39
1N5242B	6-11	1N5297	9-3	1N5369B	6-39
1N5243B	6-11	1N5298	9-3	1N5370B	6-39

## ALPHANUMERIC INDEX (continued)

DEVICE	PAGE
1N5371B	6-39
1N5372B	6-39
1N5373B	6-39
1N5374B	6-39
1N5375B	6-39
1N5376B	6-39
1N5377B	6-39
1N5378B	6-39
1N5379B	6-39
1N5380B	6-39
1N5381B	6-39
1N5382B	6-39
1N5383B	6-40
1N5384B	6-40
1N5385B	6-40
1N5386B	6-40
1N5387B	6-40
1N5388B	6-40
1N5908	4-16
1N5913B	6-31
1N5914B	6-31
1N5915B	6-31
1N5916B	6-31
1N5917B	6-31
1N5918B	6-31
1N5919B	6-31
1N5920B	6-31
1N5921B	6-31
1N5922B	6-31
1N5923B	6-31
1N5924B	6-31
1N5925B	6-31
1N5926B	6-31
1N5927B	6-31
1N5928B	6-31
1N5929B	6-31
1N5930B	6-31
1N5931B	6-31
1N5932B	6-31
1N5933B	6-31
1N5934B	6-31
1N5935B	6-31
1N5936B	6-31
1N5937B	6-31
1N5938B	6-31
1N5939B	6-31
1N5940B	6-31
1N5941B	6-31
1N5942B	6-31
1N5943B	6-31
1N5944B	6-31
1N5945B	6-31
1N5946B	6-31
1N5947B	6-31

DEVICE	PAGE
1N5948B	6-32
1N5949B	6-32
1N5950B	6-32
1N5951B	6-32
1N5952B	6-32
1N5953B	6-32
1N5954B	6-32
1N5955B	6-32
1N5956B	6-32
1N5985B	6-13
1N5986B	6-13
1N5987B	6-13
1N5988B	6-13
1N5989B	6-13
1N5990B	6-13
1N5991B	6-13
1N5992B	6-13
1N5993B	6-13
1N5994B	6-13
1N5995B	6-13
1N5996B	6-13
1N5997B	6-13
1N5998B	6-13
1N5999B	6-13
1N6000B	6-13
1N6001B	6-13
1N6002B	6-13
1N6003B	6-13
1N6004B	6-13
1N6005B	6-13
1N6006B	6-13
1N6007B	6-13
1N6008B	6-13
1N6009B	6-13
1N6010B	6-13
1N6011B	6-13
1N6012B	6-13
1N6013B	6-13
1N6014B	6-13
1N6015B	6-13
1N6016B	6-13
1N6017B	6-13
1N6018B	6-13
1N6019B	6-13
1N6020B	6-13
1N6021B	6-13
1N6022B	6-13
1N6023B	6-13
1N6024B	6-13
1N6025B	6-13
1N6267A	4-17
1N6268A	4-17
1N6269A	4-17
1N6270A	4-17

DEVICE	PAGE
1N6271A	4-17
1N6272A	4-17
1N6273A	4-17
1N6274A	4-17
1N6275A	4-17
1N6276A	4-17
1N6277A	4-17
1N6278A	4-17
1N6279A	4-17
1N6280A	4-17
1N6281A	4-17
1N6282A	4-17
1N6283A	4-17
1N6284A	4-17
1N6285A	4-17
1N6286A	4-17
1N6287A	4-17
1N6288A	4-17
1N6289	4-17
1N6290A	4-17
1N6291A	4-17
1N6292A	4-17
1N6293A	4-17
1N6294A	4-17
1N6295A	4-17
1N6296A	4-17
1N6297A	4-17
1N6298A	4-17
1N6299A	4-17
1N6300A	4-17
1N6301A	4-17
1N6302A	4-17
1N6303A	4-17
1N6373	4-19
1N6374	4-19
1N6375	4-19
1N6376	4-19
1N6377	4-19
1N6378	4-19
1N6379	4-19
1N6380	4-19
1N6381	4-19
1N6382	4-19
1N6383	4-19
1N6384	4-19
1N6385	4-19
1N6386	4-19
1N6387	4-19
1N6388	4-19
1N6389	4-19
1N746A	6-8
1N747A	6-8
1N748A	6-8
1N749A	6-8

## ALPHANUMERIC INDEX (continued)

DEVICE	PAGE
1N750A	6-8
1N751A	6-8
1N752A	6-8
1N753A	6-8
1N754A	6-8
1N755A	6-8
1N756A	6-8
1N757A	6-8
1N758A	6-8
1N759A	6-8
1N821	8-2
1N821A	8-2
1N823	8-2
1N823A	8-2
1N825	8-2
1N825A	8-2
1N827	8-2
1N827A	8-2
1N829	8-2
1N829A	8-2
1N957B	6-8
1N958B	6-8
1N959B	6-8
1N960B	6-8
1N961B	6-8
1N962B	6-8
1N963B	6-8
1N964B	6-8
1N965B	6-8
1N966B	6-8
1N967B	6-8
1N968B	6-8
1N969B	6-8
1N970B	6-8
1N971B	6-8
1N972B	6-8
1N973B	6-8
1N974B	6-8
1N975B	6-8
1N976B	6-8
1N977B	6-8
1N978B	6-8
1N979B	6-8
1N980B	6-8
1N981B	6-9
1N982B	6-9
1N983B	6-9
1N984B	6-9
1N985B	6-9
1N986B	6-9
1N987B	6-9
1N988B	6-9
1N989B	6-9
1N990B	6-9

DEVICE	PAGE
1N991B	6-9
1N992B	6-9
1SMB100AT3	5-14
1SMB10AT3	5-14
1SMB10CAT3	5-15
1SMB110AT3	5-14
1SMB11AT3	5-14
1SMB11CAT3	5-15
1SMB120AT3	5-14
1SMB12AT3	5-14
1SMB12CAT3	5-15
1SMB130AT3	5-14
1SMB13AT3	5-14
1SMB13CAT3	5-15
1SMB14AT3	5-14
1SMB14CAT3	5-15
1SMB150AT3	5-14
1SMB15AT3	5-14
1SMB15CAT3	5-15
1SMB160AT3	5-14
1SMB16AT3	5-14
1SMB16CAT3	5-15
1SMB170AT3	5-14
1SMB17AT3	5-14
1SMB17CAT3	5-15
1SMB18AT3	5-14
1SMB18CAT3	5-15
1SMB20AT3	5-14
1SMB20CAT3	5-15
1SMB22AT3	5-14
1SMB22CAT3	5-15
1SMB24AT3	5-14
1SMB24CAT3	5-15
1SMB26AT3	5-14
1SMB26CAT3	5-15
1SMB28AT3	5-14
1SMB28CAT3	5-15
1SMB30AT3	5-14
1SMB30CAT3	5-15
1SMB33AT3	5-14
1SMB33CAT3	5-15
1SMB36AT3	5-14
1SMB36CAT3	5-15
1SMB40AT3	5-14
1SMB40CAT3	5-15
1SMB43AT3	5-14
1SMB43CAT3	5-15
1SMB45AT3	5-14
1SMB45CAT3	5-15
1SMB48AT3	5-14
1SMB48CAT3	5-15
1SMB5.0AT3	5-14
1SMB5.1AT3	5-14
1SMB5.1CAT3	5-15

DEVICE	PAGE
1SMB54AT3	5-14
1SMB54CAT3	5-15
1SMB58AT3	5-14
1SMB58CAT3	5-15
1SMB5913BT3	7-17
1SMB5914BT3	7-17
1SMB5915BT3	7-17
1SMB5916BT3	7-17
1SMB5917BT3	7-17
1SMB5918BT3	7-17
1SMB5919BT3	7-17
1SMB5920BT3	7-17
1SMB5921BT3	7-17
1SMB5922BT3	7-17
1SMB5923BT3	7-17
1SMB5924BT3	7-17
1SMB5925BT3	7-17
1SMB5926BT3	7-17
1SMB5927BT3	7-17
1SMB5928BT3	7-17
1SMB5929BT3	7-18
1SMB5930BT3	7-18
1SMB5931BT3	7-18
1SMB5932BT3	7-18
1SMB5933BT3	7-18
1SMB5934BT3	7-18
1SMB5935BT3	7-18
1SMB5936BT3	7-18
1SMB5937BT3	7-18
1SMB5938BT3	7-18
1SMB5939BT3	7-18
1SMB5940BT3	7-18
1SMB5941BT3	7-18
1SMB5942BT3	7-18
1SMB5943BT3	7-18
1SMB5944BT3	7-18
1SMB5945BT3	7-18
1SMB5946BT3	7-18
1SMB5947BT3	7-18
1SMB5948BT3	7-18
1SMB5949BT3	7-18
1SMB5950BT3	7-18
1SMB5951BT3	7-18
1SMB5952BT3	7-18
1SMB5953BT3	7-18
1SMB5954BT3	7-18
1SMB5955BT3	7-18
1SMB5956BT3	7-18
1SMB6.0AT3	5-14
1SMB6.5AT3	5-14
1SMB60AT3	5-14
1SMB60CAT3	5-15
1SMB64AT3	5-14
1SMB64CAT3	5-15

## ALPHANUMERIC INDEX (continued)

DEVICE	PAGE
1SMB7.0AT3	5-14
1SMB7.5AT3	5-14
1SMB70AT3	5-14
1SMB70CAT3	5-15
1SMB75AT3	5-14
1SMB75CAT3	5-15
1SMB78AT3	5-14
1SMB78CAT3	5-15
1SMB8.0AT3	5-14
1SMB8.5AT3	5-14
1SMB85AT3	5-14
1SMB9.0AT3	5-14
1SMB90AT3	5-14
1SMC10AT3	5-22
1SMC11AT3	5-22
1SMC12AT3	5-22
1SMC13AT3	5-22
1SMC14AT3	5-22
1SMC15AT3	5-22
1SMC16AT3	5-22
1SMC17AT3	5-22
1SMC18AT3	5-22
1SMC20AT3	5-22
1SMC22AT3	5-22
1SMC24AT3	5-22
1SMC26AT3	5-22
1SMC28AT3	5-22
1SMC30AT3	5-22
1SMC33AT3	5-22
1SMC36AT3	5-22
1SMC40AT3	5-22
1SMC43AT3	5-22
1SMC45AT3	5-22
1SMC48AT3	5-22
1SMC5.0AT3	5-22
1SMC51AT3	5-22
1SMC54AT3	5-22
1SMC58AT3	5-22
1SMC6.0AT3	5-22
1SMC6.5AT3	5-22
1SMC60AT3	5-22
1SMC64AT3	5-22
1SMC7.0AT3	5-22
1SMC7.5AT3	5-22
1SMC70AT3	5-22
1SMC75AT3	5-22
1SMC78AT3	5-22
1SMC8.0AT3	5-22
1SMC8.5AT3	5-22
1SMC9.0AT3	5-22
3EZ100D5	6-33
3EZ10D5	6-33
3EZ110D5	6-33
3EZ11D5	6-33

DEVICE	PAGE
3EZ120D5	6-33
3EZ12D5	6-33
3EZ130D5	6-33
3EZ13D5	6-33
3EZ140D5	6-33
3EZ14D5	6-33
3EZ150D5	6-33
3EZ15D5	6-33
3EZ160D5	6-33
3EZ16D5	6-33
3EZ170D5	6-33
3EZ17D5	6-33
3EZ180D5	6-33
3EZ18D5	6-33
3EZ190D5	6-33
3EZ19D5	6-33
3EZ200D5	6-34
3EZ20D5	6-33
3EZ220D5	6-34
3EZ22D5	6-33
3EZ240D5	6-34
3EZ24D5	6-33
3EZ270D5	6-34
3EZ27D5	6-33
3EZ28D5	6-33
3EZ3.9D5	6-33
3EZ300D5	6-34
3EZ30D5	6-33
3EZ330D5	6-34
3EZ33D5	6-33
3EZ360D5	6-34
3EZ36D5	6-33
3EZ39D5	6-33
3EZ4.3D5	6-33
3EZ4.7D5	6-33
3EZ400D5	6-34
3EZ43D5	6-33
3EZ47D5	6-33
3EZ5.1D5	6-33
3EZ5.6D5	6-33
3EZ51D5	6-33
3EZ56D5	6-33
3EZ6.2D5	6-33
3EZ6.8D5	6-33
3EZ62D5	6-33
3EZ68D5	6-33
3EZ7.5D5	6-33
3EZ75D5	6-33
3EZ8.2D5	6-33
3EZ82D5	6-33
3EZ9.1D5	6-33
3EZ91D5	6-33
BZX55C10RL	6-14
BZX55C11RL	6-14

DEVICE	PAGE
BZX55C12RL	6-14
BZX55C13RL	6-14
BZX55C15RL	6-14
BZX55C16RL	6-14
BZX55C18RL	6-14
BZX55C20RL	6-14
BZX55C22RL	6-14
BZX55C24RL	6-14
BZX55C27RL	6-14
BZX55C2V4RL	6-14
BZX55C2V7RL	6-14
BZX55C30RL	6-14
BZX55C33RL	6-14
BZX55C36RL	6-14
BZX55C39RL	6-14
BZX55C3V0RL	6-14
BZX55C3V3RL	6-14
BZX55C3V6RL	6-14
BZX55C3V9RL	6-14
BZX55C43RL	6-14
BZX55C47RL	6-14
BZX55C4V3RL	6-14
BZX55C4V7RL	6-14
BZX55C51RL	6-14
BZX55C56RL	6-14
BZX55C5V1RL	6-14
BZX55C5V6RL	6-14
BZX55C62RL	6-14
BZX55C68RL	6-14
BZX55C6V2RL	6-14
BZX55C6V8RL	6-14
BZX55C75RL	6-14
BZX55C7V5RL	6-14
BZX55C82RL	6-14
BZX55C8V2RL	6-14
BZX55C91RL	6-14
BZX55C9V1RL	6-14
BZX79C100RL	6-15
BZX79C10RL	6-15
BZX79C110RL	6-15
BZX79C11RL	6-15
BZX79C120RL	6-15
BZX79C12RL	6-15
BZX79C130RL	6-15
BZX79C13RL	6-15
BZX79C150RL	6-15
BZX79C15RL	6-15
BZX79C160RL	6-15
BZX79C16RL	6-15
BZX79C180RL	6-15
BZX79C18RL	6-15
BZX79C200RL	6-15
BZX79C20RL	6-15
BZX79C22RL	6-15

## ALPHANUMERIC INDEX (continued)

DEVICE	PAGE	DEVICE	PAGE	DEVICE	PAGE
BZX79C24RL	6-15	BZX83C7V5RL	6-16	BZX85C36RL	6-25
BZX79C27RL	6-15	BZX83C8V2RL	6-16	BZX85C39RL	6-25
BZX79C2V4RL	6-15	BZX83C9V1RL	6-16	BZX85C3V3RL	6-25
BZX79C2V7RL	6-15	BZX84C10LT1	7-5	BZX85C3V6RL	6-25
BZX79C30RL	6-15	BZX84C11LT1	7-5	BZX85C3V9RL	6-25
BZX79C33RL	6-15	BZX84C12LT1	7-5	BZX85C43RL	6-25
BZX79C36RL	6-15	BZX84C13LT1	7-5	BZX85C47RL	6-25
BZX79C39RL	6-15	BZX84C15LT1	7-5	BZX85C4V3RL	6-25
BZX79C3V0RL	6-15	BZX84C16LT1	7-5	BZX85C4V7RL	6-25
BZX79C3V3RL	6-15	BZX84C18LT1	7-5	BZX85C51RL	6-25
BZX79C3V6RL	6-15	BZX84C20LT1	7-5	BZX85C56RL	6-25
BZX79C3V9RL	6-15	BZX84C22LT1	7-5	BZX85C5V1RL	6-25
BZX79C43RL	6-15	BZX84C24LT1	7-5	BZX85C5V6RL	6-25
BZX79C47RL	6-15	BZX84C27LT1	7-5	BZX85C62RL	6-25
BZX79C4V3RL	6-15	BZX84C2V4LT1	7-5	BZX85C68RL	6-25
BZX79C4V7RL	6-15	BZX84C2V7LT1	7-5	BZX85C6V2RL	6-25
BZX79C51RL	6-15	BZX84C30LT1	7-5	BZX85C6V8RL	6-25
BZX79C56RL	6-15	BZX84C33LT1	7-5	BZX85C75RL	6-25
BZX79C5V1RL	6-15	BZX84C36LT1	7-5	BZX85C7V5RL	6-25
BZX79C5V6RL	6-15	BZX84C39LT1	7-5	BZX85C82RL	6-25
BZX79C62RL	6-15	BZX84C3V0LT1	7-5	BZX85C8V2RL	6-25
BZX79C68RL	6-15	BZX84C3V3LT1	7-5	BZX85C91RL	6-25
BZX79C6V2RL	6-15	BZX84C3V6LT1	7-5	BZX85C9V1RL	6-25
BZX79C6V8RL	6-15	BZX84C3V9LT1	7-5	ICTE-10	4-19
BZX79C75RL	6-15	BZX84C43LT1	7-5	ICTE-10C	4-19
BZX79C7V5RL	6-15	BZX84C47LT1	7-5	ICTE-12	4-19
BZX79C82RL	6-15	BZX84C4V3LT1	7-5	ICTE-12C	4-19
BZX79C8V2RL	6-15	BZX84C4V7LT1	7-5	ICTE-15	4-19
BZX79C91RL	6-15	BZX84C51LT1	7-5	ICTE-15C	4-19
BZX79C9V1RL	6-15	BZX84C56LT1	7-5	ICTE-18	4-19
BZX83C10RL	6-16	BZX84C5V1LT1	7-5	ICTE-18C	4-19
BZX83C11RL	6-16	BZX84C5V6LT1	7-5	ICTE-22	4-19
BZX83C12RL	6-16	BZX84C62LT1	7-5	ICTE-22C	4-19
BZX83C13RL	6-16	BZX84C68LT1	7-5	ICTE-36	4-19
BZX83C15RL	6-16	BZX84C6V2LT1	7-5	ICTE-36C	4-19
BZX83C16RL	6-16	BZX84C6V8LT1	7-5	ICTE-45	4-19
BZX83C18RL	6-16	BZX84C75LT1	7-5	ICTE-45C	4-19
BZX83C20RL	6-16	BZX84C7V5LT1	7-5	ICTE-5	4-19
BZX83C22RL	6-16	BZX84C8V2LT1	7-5	ICTE-8	4-19
BZX83C24RL	6-16	BZX84C9V1LT1	7-5	ICTE-8C	4-19
BZX83C27RL	6-16	BZX85C100RL	6-25	MMBZ5221BLT1	7-6
BZX83C2V7RL	6-16	BZX85C10RL	6-25	MMBZ5222BLT1	7-6
BZX83C30RL	6-16	BZX85C11RL	6-25	MMBZ5223BLT1	7-6
BZX83C33RL	6-16	BZX85C12RL	6-25	MMBZ5224BLT1	7-6
BZX83C3V0RL	6-16	BZX85C13RL	6-25	MMBZ5225BLT1	7-6
BZX83C3V3RL	6-16	BZX85C15RL	6-25	MMBZ5226BLT1	7-6
BZX83C3V6RL	6-16	BZX85C16RL	6-25	MMBZ5227BLT1	7-6
BZX83C3V9RL	6-16	BZX85C18RL	6-25	MMBZ5228BLT1	7-6
BZX83C4V3RL	6-16	BZX85C20RL	6-25	MMBZ5229BLT1	7-6
BZX83C4V7RL	6-16	BZX85C22RL	6-25	MMBZ5230BLT1	7-6
BZX83C5V1RL	6-16	BZX85C24RL	6-25	MMBZ5231BLT1	7-6
BZX83C5V6RL	6-16	BZX85C27RL	6-25	MMBZ5232BLT1	7-6
BZX83C6V2RL	6-16	BZX85C30RL	6-25	MMBZ5233BLT1	7-6
BZX83C6V8RL	6-16	BZX85C33RL	6-25	MMBZ5234BLT1	7-6

## ALPHANUMERIC INDEX (continued)

DEVICE	PAGE
MMBZ5235BLT1	7-6
MMBZ5236BLT1	7-6
MMBZ5237BLT1	7-6
MMBZ5238BLT1	7-6
MMBZ5239BLT1	7-6
MMBZ5240BLT1	7-6
MMBZ5241BLT1	7-6
MMBZ5242BLT1	7-6
MMBZ5243BLT1	7-6
MMBZ5244BLT1	7-6
MMBZ5245BLT1	7-6
MMBZ5246BLT1	7-6
MMBZ5247BLT1	7-6
MMBZ5248BLT1	7-6
MMBZ5249BLT1	7-6
MMBZ5250BLT1	7-6
MMBZ5251BLT1	7-6
MMBZ5252BLT1	7-6
MMBZ5253BLT1	7-6
MMBZ5254BLT1	7-6
MMBZ5255BLT1	7-6
MMBZ5256BLT1	7-6
MMBZ5257BLT1	7-6
MMBZ5258BLT1	7-6
MMBZ5259BLT1	7-6
MMBZ5260BLT1	7-6
MMBZ5261BLT1	7-6
MMBZ5262BLT1	7-6
MMBZ5263BLT1	7-6
MMBZ5264BLT1	7-6
MMBZ5265BLT1	7-6
MMBZ5266BLT1	7-6
MMBZ5267BLT1	7-6
MMBZ5268BLT1	7-6
MMBZ5269BLT1	7-6
MMBZ5270BLT1	7-6
MMBZ5V6ALT1	5-2
MMSZ10T1	7-14
MMSZ11T1	7-14
MMSZ12T1	7-14
MMSZ13T1	7-14
MMSZ15T1	7-14
MMSZ16T1	7-14
MMSZ18T1	7-14
MMSZ20T1	7-14
MMSZ22T1	7-14
MMSZ24T1	7-14
MMSZ27T1	7-14
MMSZ2V4T1	7-14
MMSZ2V7T1	7-14
MMSZ30T1	7-14
MMSZ33T1	7-14
MMSZ36T1	7-14
MMSZ39T1	7-14

DEVICE	PAGE
MMSZ3V0T1	7-14
MMSZ3V3T1	7-14
MMSZ3V6T1	7-14
MMSZ3V9T1	7-14
MMSZ43T1	7-14
MMSZ4678T1	7-13
MMSZ4679T1	7-13
MMSZ4680T1	7-13
MMSZ4681T1	7-13
MMSZ4682T1	7-13
MMSZ4683T1	7-13
MMSZ4684T1	7-13
MMSZ4685T1	7-13
MMSZ4686T1	7-13
MMSZ4687T1	7-13
MMSZ4688T1	7-13
MMSZ4689T1	7-13
MMSZ4690T1	7-13
MMSZ4691T1	7-13
MMSZ4692T1	7-13
MMSZ4693T1	7-13
MMSZ4694T1	7-13
MMSZ4695T1	7-13
MMSZ4696T1	7-13
MMSZ4697T1	7-13
MMSZ4698T1	7-13
MMSZ4699T1	7-13
MMSZ4700T1	7-13
MMSZ4701T1	7-13
MMSZ4702T1	7-13
MMSZ4703T1	7-13
MMSZ4704T1	7-13
MMSZ4705T1	7-13
MMSZ4706T1	7-13
MMSZ4707T1	7-13
MMSZ4708T1	7-13
MMSZ4709T1	7-13
MMSZ4710T1	7-13
MMSZ4711T1	7-13
MMSZ4712T1	7-13
MMSZ4713T1	7-13
MMSZ4714T1	7-13
MMSZ4715T1	7-13
MMSZ4716T1	7-13
MMSZ4717T1	7-13
MMSZ47T1	7-14
MMSZ4V3T1	7-14
MMSZ4V7T1	7-14
MMSZ51T1	7-14
MMSZ5221BT1	7-11
MMSZ5222BT1	7-11
MMSZ5223BT1	7-11
MMSZ5224BT1	7-11
MMSZ5225BT1	7-11

DEVICE	PAGE
MMSZ5226BT1	7-11
MMSZ5227BT1	7-11
MMSZ5228BT1	7-11
MMSZ5229BT1	7-11
MMSZ5230BT1	7-11
MMSZ5231BT1	7-11
MMSZ5232BT1	7-11
MMSZ5233BT1	7-11
MMSZ5234BT1	7-11
MMSZ5235BT1	7-11
MMSZ5236BT1	7-11
MMSZ5237BT1	7-11
MMSZ5238BT1	7-11
MMSZ5239BT1	7-11
MMSZ5240BT1	7-11
MMSZ5241BT1	7-11
MMSZ5242BT1	7-11
MMSZ5243BT1	7-11
MMSZ5244BT1	7-11
MMSZ5245BT1	7-11
MMSZ5246BT1	7-11
MMSZ5247BT1	7-11
MMSZ5248BT1	7-11
MMSZ5249BT1	7-11
MMSZ5250BT1	7-11
MMSZ5251BT1	7-11
MMSZ5252BT1	7-11
MMSZ5253BT1	7-11
MMSZ5254BT1	7-11
MMSZ5255BT1	7-11
MMSZ5256BT1	7-12
MMSZ5257BT1	7-12
MMSZ5258BT1	7-12
MMSZ5259BT1	7-12
MMSZ5260BT1	7-12
MMSZ5261BT1	7-12
MMSZ5262BT1	7-12
MMSZ5263BT1	7-12
MMSZ5264BT1	7-12
MMSZ5265BT1	7-12
MMSZ5266BT1	7-12
MMSZ5267BT1	7-12
MMSZ5268BT1	7-12
MMSZ5269BT1	7-12
MMSZ5270BT1	7-12
MMSZ56T1	7-14
MMSZ5V1T1	7-14
MMSZ5V6T1	7-14
MMSZ62T1	7-14
MMSZ68T1	7-14
MMSZ6V2T1	7-14
MMSZ6V8T1	7-14
MMSZ75T1	7-14
MMSZ7V5T1	7-14

## ALPHANUMERIC INDEX (continued)

DEVICE	PAGE	DEVICE	PAGE	DEVICE	PAGE
MMSZ8V2T1	7-14	MZD110	6-35	MZP4743A	6-36
MMSZ9V1T1	7-14	MZD12	6-35	MZP4744A	6-36
MR2535L	4-21	MZD120	6-35	MZP4745A	6-36
MPTE-10	4-19	MZD13	6-35	MZP4746A	6-36
MPTE-10C	4-19	MZD130	6-35	MZP4747A	6-36
MPTE-12	4-19	MZD15	6-35	MZP4748A	6-36
MPTE-12C	4-19	MZD150	6-35	MZP4749A	6-36
MPTE-15	4-19	MZD16	6-35	MZP4750A	6-36
MPTE-15C	4-19	MZD160	6-35	MZP4751A	6-36
MPTE-18	4-19	MZD18	6-35	MZP4752A	6-36
MPTE-18C	4-19	MZD180	6-35	MZP4753A	6-36
MPTE-22	4-19	MZD20	6-35	MZP4754A	6-36
MPTE-22C	4-19	MZD200	6-35	MZP4755A	6-36
MPTE-36	4-19	MZD22	6-35	MZP4756A	6-36
MPTE-36C	4-19	MZD24	6-35	MZP4757A	6-36
MPTE-45	4-19	MZD27	6-35	MZP4758A	6-36
MPTE-45C	4-19	MZD3.9	6-35	MZP4759A	6-36
MPTE-5	4-19	MZD30	6-35	MZP4760A	6-36
MPTE-8	4-19	MZD33	6-35	MZP4761A	6-36
MPTE-8C	4-19	MZD36	6-35	MZP4762A	6-36
MZ4099	6-17	MZD39	6-35	MZP4763A	6-36
MZ4100	6-17	MZD4.3	6-35	MZP4764A	6-36
MZ4101	6-17	MZD4.7	6-35	MZPY100RL	6-26
MZ4102	6-17	MZD43	6-35	MZPY10RL	6-26
MZ4103	6-17	MZD47	6-35	MZPY11RL	6-26
MZ4104	6-17	MZD5.1	6-35	MZPY12RL	6-26
MZ4614	6-17	MZD5.6	6-35	MZPY13RL	6-26
MZ4615	6-17	MZD51	6-35	MZPY15RL	6-26
MZ4616	6-17	MZD56	6-35	MZPY16RL	6-26
MZ4617	6-17	MZD6.2	6-35	MZPY18RL	6-26
MZ4618	6-17	MZD6.8	6-35	MZPY20RL	6-26
MZ4619	6-17	MZD62	6-35	MZPY22RL	6-26
MZ4620	6-17	MZD68	6-35	MZPY24RL	6-26
MZ4621	6-17	MZD7.5	6-35	MZPY27RL	6-26
MZ4622	6-17	MZD75	6-35	MZPY3.9RL	6-26
MZ4623	6-17	MZD8.2	6-35	MZPY30RL	6-26
MZ4624	6-17	MZD82	6-35	MZPY33RL	6-26
MZ4625	6-17	MZD9.1	6-35	MZPY36RL	6-26
MZ4626	6-17	MZD91	6-35	MZPY39RL	6-26
MZ4627	6-17	MZP4728A	6-36	MZPY4.3RL	6-26
MZ5520B	6-18	MZP4729A	6-36	MZPY4.7RL	6-26
MZ5521B	6-18	MZP4730A	6-36	MZPY43RL	6-26
MZ5522B	6-18	MZP4731A	6-36	MZPY47RL	6-26
MZ5523B	6-18	MZP4732A	6-36	MZPY5.1RL	6-26
MZ5524B	6-18	MZP4733A	6-36	MZPY5.6RL	6-26
MZ5525B	6-18	MZP4734A	6-36	MZPY51RL	6-26
MZ5526B	6-18	MZP4735A	6-36	MZPY56RL	6-26
MZ5527B	6-18	MZP4736A	6-36	MZPY6.2RL	6-26
MZ5528B	6-18	MZP4737A	6-36	MZPY6.8RL	6-26
MZ5529B	6-18	MZP4738A	6-36	MZPY62RL	6-26
MZ5530B	6-18	MZP4739A	6-36	MZPY68RL	6-26
MZD10	6-35	MZP4740A	6-36	MZPY7.5RL	6-26
MZD100	6-35	MZP4741A	6-36	MZPY75RL	6-26
MZD11	6-35	MZP4742A	6-36	MZPY8.2RL	6-26



## ALPHANUMERIC INDEX (continued)

DEVICE	PAGE
MZPY82RL	6-26
MZPY9.1RL	6-26
MZPY91RL	6-26
P6KE100A	4-7
P6KE100CA	4-7
P6KE10A	4-7
P6KE10CA	4-7
P6KE110A	4-7
P6KE110CA	4-7
P6KE11A	4-7
P6KE11CA	4-7
P6KE120A	4-7
P6KE120CA	4-7
P6KE12A	4-7
P6KE12CA	4-7
P6KE130A	4-7
P6KE130CA	4-7
P6KE13A	4-7
P6KE13CA	4-7
P6KE150A	4-7
P6KE150CA	4-7
P6KE15A	4-7
P6KE15CA	4-7
P6KE160A	4-7
P6KE160CA	4-7
P6KE16A	4-7
P6KE16CA	4-7
P6KE170A	4-7
P6KE170CA	4-7
P6KE180A	4-7
P6KE180CA	4-7
P6KE18A	4-7
P6KE18CA	4-7
P6KE200A	4-7
P6KE200CA	4-7
P6KE20A	4-7
P6KE20CA	4-7
P6KE22A	4-7
P6KE22CA	4-7
P6KE24A	4-7
P6KE24CA	4-7
P6KE27A	4-7
P6KE27CA	4-7
P6KE30A	4-7
P6KE30CA	4-7
P6KE33A	4-7
P6KE33CA	4-7
P6KE36A	4-7
P6KE36CA	4-7
P6KE39A	4-7
P6KE39CA	4-7
P6KE43A	4-7
P6KE43CA	4-7
P6KE47A	4-7

DEVICE	PAGE
P6KE47CA	4-7
P6KE51A	4-7
P6KE51CA	4-7
P6KE56A	4-7
P6KE56CA	4-7
P6KE6.8A	4-7
P6KE6.8CA	4-7
P6KE62A	4-7
P6KE62CA	4-7
P6KE68A	4-7
P6KE68CA	4-7
P6KE7.5A	4-7
P6KE7.5CA	4-7
P6KE75A	4-7
P6KE75CA	4-7
P6KE8.2A	4-7
P6KE8.2CA	4-7
P6KE82A	4-7
P6KE82CA	4-7
P6KE9.1A	4-7
P6KE9.1CA	4-7
P6KE91A	4-7
P6KE91CA	4-7
P6SMB100AT3	5-16
P6SMB10AT3	5-16
P6SMB110AT3	5-16
P6SMB11AT3	5-16
P6SMB11CAT3	5-17
P6SMB120AT3	5-16
P6SMB12AT3	5-16
P6SMB12CAT3	5-17
P6SMB130AT3	5-16
P6SMB13AT3	5-16
P6SMB13CAT3	5-17
P6SMB150AT3	5-16
P6SMB15AT3	5-16
P6SMB15CAT3	5-17
P6SMB160AT3	5-16
P6SMB16AT3	5-16
P6SMB16CAT3	5-17
P6SMB170AT3	5-16
P6SMB180AT3	5-16
P6SMB18AT3	5-16
P6SMB18CAT3	5-17
P6SMB200AT3	5-16
P6SMB20AT3	5-16
P6SMB20CAT3	5-17
P6SMB22AT3	5-16
P6SMB22CAT3	5-17
P6SMB24AT3	5-16
P6SMB24CAT3	5-17
P6SMB27AT3	5-16
P6SMB27CAT3	5-17
P6SMB30AT3	5-16

DEVICE	PAGE
P6SMB30CAT3	5-17
P6SMB33AT3	5-16
P6SMB33CAT3	5-17
P6SMB36AT3	5-16
P6SMB36CAT3	5-17
P6SMB39AT3	5-16
P6SMB39CAT3	5-17
P6SMB43AT3	5-16
P6SMB43CAT3	5-17
P6SMB47AT3	5-16
P6SMB47CAT3	5-17
P6SMB51AT3	5-16
P6SMB51CAT3	5-17
P6SMB56AT3	5-16
P6SMB56CAT3	5-17
P6SMB6.8AT3	5-16
P6SMB62AT3	5-16
P6SMB62CAT3	5-17
P6SMB68AT3	5-16
P6SMB68CAT3	5-17
P6SMB7.5AT3	5-16
P6SMB75AT3	5-16
P6SMB75CAT3	5-17
P6SMB8.2AT3	5-16
P6SMB82AT3	5-16
P6SMB82CAT3	5-17
P6SMB9.1AT3	5-16
P6SMB91AT3	5-16
P6SMB91CAT3	5-17
SA100A	4-3
SA100CA	4-3
SA10A	4-3
SA10CA	4-3
SA110A	4-3
SA110CA	4-3
SA11A	4-3
SA11CA	4-3
SA120A	4-3
SA120CA	4-3
SA12A	4-3
SA12CA	4-3
SA130A	4-3
SA130CA	4-3
SA13A	4-3
SA13CA	4-3
SA14A	4-3
SA14CA	4-3
SA150A	4-3
SA150CA	4-3
SA15A	4-3
SA15CA	4-3
SA160A	4-3
SA160CA	4-3
SA16A	4-3

## ALPHANUMERIC INDEX (continued)

DEVICE	PAGE
SA16CA	4-3
SA170A	4-3
SA170CA	4-3
SA17A	4-3
SA17CA	4-3
SA18A	4-3
SA18CA	4-3
SA20A	4-3
SA20CA	4-3
SA22A	4-3
SA22CA	4-3
SA24A	4-3
SA24CA	4-3
SA26A	4-3
SA26CA	4-3
SA28A	4-3
SA28CA	4-3
SA30A	4-3
SA30CA	4-3
SA33A	4-3
SA33CA	4-3
SA36A	4-3
SA36CA	4-3
SA40A	4-3
SA40CA	4-3
SA43A	4-3
SA43CA	4-3
SA45A	4-3
SA45CA	4-3
SA48A	4-3
SA48CA	4-3

DEVICE	PAGE
SA5.0A	4-3
SA51A	4-3
SA51CA	4-3
SA54A	4-3
SA54CA	4-3
SA58A	4-3
SA58CA	4-3
SA6.0A	4-3
SA6.0CA	4-3
SA6.5A	4-3
SA6.5CA	4-3
SA60A	4-3
SA60CA	4-3
SA64A	4-3
SA64CA	4-3
SA7.0A	4-3
SA7.0CA	4-3
SA7.5A	4-3
SA7.5CA	4-3
SA70A	4-3
SA70CA	4-3
SA75A	4-3
SA75CA	4-3
SA78A	4-3
SA78CA	4-3
SA8.0A	4-3
SA8.0CA	4-3
SA8.5A	4-3
SA8.5CA	4-3
SA85A	4-3
SA85CA	4-3

DEVICE	PAGE
SA9.0A	4-3
SA9.0CA	4-3
SA90A	4-3
SA90CA	4-3
ZPD10RL	6-16
ZPD11RL	6-16
ZPD12RL	6-16
ZPD13RL	6-16
ZPD15RL	6-16
ZPD16RL	6-16
ZPD18RL	6-16
ZPD2.7RL	6-16
ZPD20RL	6-16
ZPD22RL	6-16
ZPD24RL	6-16
ZPD27RL	6-16
ZPD3.0RL	6-16
ZPD3.3RL	6-16
ZPD3.6RL	6-16
ZPD3.9RL	6-16
ZPD30RL	6-16
ZPD33RL	6-16
ZPD4.3RL	6-16
ZPD4.7RL	6-16
ZPD5.1RL	6-16
ZPD5.6RL	6-16
ZPD6.2RL	6-16
ZPD6.8RL	6-16
ZPD7.5RL	6-16
ZPD8.2RL	6-16
ZPD9.1RL	6-16



**For:colleen**

**Printed on:Tue, Jun 30, 1998 16:03:23**

**From book:DL150\_SEC2 (2) VIEW**

**Document:DL150\_SEC2\_TOC VIEW**

**Last saved on:Tue, Jun 30, 1998 15:43:43**

**Document:DL150\_CR VIEW**

**Last saved on:Tue, Jun 30, 1998 15:43:48**

# Section Two

2

## Cross Reference and Index

This Cross Reference and Index lists industry devices by the EIA, European, or in-house part number for which there is a nearest or similar Motorola replacement. The replacement columns show nearest or similar replacements. The similar device differs in electrical and/or case style from the referenced industry type number. Substitution acceptability can be determined by reviewing the Electrical Characteristics and Case Dimensions given on the Motorola Data Sheet. For devices not shown in this Cross Reference Guide, or for further information, the user should contact a Motorola factory representative.

**CROSS-REFERENCE (continued)**

Industry Part Number	Motorola Direct Replacement	Motorola Similar Replacement	Page Number
.4T110		1N5272B	6-12
.4T110A		1N5272B	6-12
.4T110B		1N5272B	6-12
.4T12		1N5242B	6-11
.4T12A		1N5242B	6-11
.4T12B		1N5242B	6-11
.4T5.6		1N5232B	6-11
.4T5.6A		1N5232B	6-11
.4T5.6B		1N5232B	6-11
.4T6.8		1N5235B	6-11
.4T6.8A		1N5235B	6-11
.4T6.8B		1N5235B	6-11
.4Z110D		1N5272B	6-12
.4Z110D10		1N5272B	6-12
.4Z110D5		1N5272B	6-12
.4Z6.8D		1N5235B	6-11
.4Z6.8D10		1N5235B	6-11
.4Z6.8D5		1N5235B	6-11
.5M110Z10	1N5272B		6-12
.5M110Z5	1N5272B		6-12
.5M110ZS	1N5272B		6-12
.5M2.4ZS	1N5221B		6-11
.5M2.4ZS10	1N5221B		6-11
.5M2.4ZS5	1N5221B		6-11
0.25T110		1N5272B	6-12
0.25T110A		1N5272B	6-12
0.25T5.6		1N5232B	6-11
0.25T5.6A		1N5232B	6-11
1.0KE100A		1N6297A	4-17
1.0KE100CA		1.5KE120CA	4-17
1.0KE10A		1N6273A	4-17
1.0KE10CA		1.5KE12CA	4-17
1.0KE110A		1N6298A	4-17
1.0KE110CA		1.5KE130CA	4-17
1.0KE11A		1N6274A	4-17
1.0KE11CA		1.5KE13CA	4-17
1.0KE120A		1N6299A	4-17
1.0KE120CA		1.5KE150CA	4-17
1.0KE12A		1N6275A	4-17
1.0KE12CA		1.5KE15CA	4-17
1.0KE130A		1N6300A	4-17
1.0KE130CA		1.5KE160CA	4-17
1.0KE13A		1N6275A	4-17
1.0KE13CA		1.5KE15CA	4-17
1.0KE14A		1N6277A	4-17
1.0KE14CA		1.5KE18CA	4-17
1.0KE150A		1N6302A	4-17
1.0KE150CA		1.5KE180CA	4-17
1.0KE15A		1N6277A	4-17
1.0KE15CA		1.5KE18CA	4-17

Industry Part Number	Motorola Direct Replacement	Motorola Similar Replacement	Page Number
1.0KE160A		1N6303A	4-17
1.0KE160CA		1.5KE200CA	4-17
1.0KE16A		1N6278A	4-17
1.0KE16CA		1.5KE20CA	4-17
1.0KE170A		1N6303A	4-17
1.0KE170CA		1.5KE200CA	4-17
1.0KE17A		1N6278A	4-17
1.0KE17CA		1.5KE20CA	4-17
1.0KE18A		1N6279A	4-17
1.0KE18CA		1.5KE22CA	4-17
1.0KE20A		1N6280A	4-17
1.0KE20CA		1.5KE24CA	4-17
1.0KE22A		1N6281A	4-17
1.0KE22CA		1.5KE27CA	4-17
1.0KE24A		1N6282A	4-17
1.0KE24CA		1.5KE30CA	4-17
1.0KE26A		1N6283A	4-17
1.0KE26CA		1.5KE33CA	4-17
1.0KE28A		1N6283A	4-17
1.0KE28CA		1.5KE33CA	4-17
1.0KE30A		1N6284A	4-17
1.0KE30CA		1.5KE36CA	4-17
1.0KE33A		1N6285A	4-17
1.0KE33CA		1.5KE39CA	4-17
1.0KE36A		1N6286A	4-17
1.0KE36CA		1.5KE43CA	4-17
1.0KE40A		1N6287A	4-17
1.0KE40CA		1.5KE47CA	4-17
1.0KE43A		1N6288A	4-17
1.0KE43CA		1.5KE51CA	4-17
1.0KE45A		1N6289A	4-17
1.0KE45CA		1.5KE56CA	4-17
1.0KE48A		1N6289A	4-17
1.0KE48CA		1.5KE56CA	4-17
1.0KE5.0A		1N6267A	4-17
1.0KE5.0CA		1.5KE6.8CA	4-17
1.0KE51A		1N6290A	4-17
1.0KE51CA		1.5KE62CA	4-17
1.0KE54A		1N6291A	4-17
1.0KE54CA		1.5KE68CA	4-17
1.0KE58A		1N6291A	4-17
1.0KE58CA		1.5KE68CA	4-17
1.0KE6.0A		1N6268A	4-17
1.0KE6.0CA		1.5KE7.5CA	4-17
1.0KE6.5A		1N6268A	4-17
1.0KE6.5CA		1.5KE7.5CA	4-17
1.0KE60A		1N6292A	4-17
1.0KE60CA		1.5KE75CA	4-17
1.0KE64A		1N6292A	4-17
1.0KE64CA		1.5KE75CA	4-17

CF = consult factory representative

**CROSS-REFERENCE (continued)**

Industry Part Number	Motorola Direct Replacement	Motorola Similar Replacement	Page Number
1.0KE7.0A		1N6269A	4-17
1.0KE7.0CA		1.5KE8.2CA	4-17
1.0KE7.5A		1N6270A	4-17
1.0KE7.5CA		1.5KE9.1CA	4-17
1.0KE70A		1N6293A	4-17
1.0KE70CA		1.5KE82CA	4-17
1.0KE75A		1N6294A	4-17
1.0KE75CA		1.5KE91CA	4-17
1.0KE78A		1N6294A	4-17
1.0KE78CA		1.5KE91CA	4-17
1.0KE8.0A		1N6271A	4-17
1.0KE8.0CA		1.5KE10CA	4-17
1.0KE8.5A		1N6271A	4-17
1.0KE8.5CA		1.5KE10CA	4-17
1.0KE85A		1N6295A	4-17
1.0KE85CA		1.5KE100CA	4-17
1.0KE9.0A		1N6272A	4-17
1.0KE9.0CA		1.5KE11CA	4-17
1.0KE90A		1N6296A	4-17
1.0KE90CA		1.5KE110CA	4-17
1.2KE100A		1N6297A	4-17
1.2KE100CA		1.5KE120CA	4-17
1.2KE10A		1N6273A	4-17
1.2KE10CA		1.5KE12CA	4-17
1.2KE110A		1N6298A	4-17
1.2KE110CA		1.5KE130CA	4-17
1.2KE11A		1N6274A	4-17
1.2KE11CA		1.5KE13CA	4-17
1.2KE120A		1N6299A	4-17
1.2KE120CA		1.5KE150CA	4-17
1.2KE12A		1N6275A	4-17
1.2KE12CA		1.5KE15CA	4-17
1.2KE130A		1N6300A	4-17
1.2KE130CA		1.5KE160CA	4-17
1.2KE13A		1N6275A	4-17
1.2KE13CA		1.5KE15CA	4-17
1.2KE14A		1N6277A	4-17
1.2KE14CA		1.5KE18CA	4-17
1.2KE150A		1N6302A	4-17
1.2KE150CA		1.5KE180CA	4-17
1.2KE15A		1N6277A	4-17
1.2KE15CA		1.5KE18CA	4-17
1.2KE160A		1N6303A	4-17
1.2KE160CA		1.5KE200CA	4-17
1.2KE16A		1N6278A	4-17
1.2KE16CA		1.5KE20CA	4-17
1.2KE170A		1N6303A	4-17
1.2KE170CA		1.5KE200CA	4-17
1.2KE17A		1N6278A	4-17
1.2KE17CA		1.5KE20CA	4-17

Industry Part Number	Motorola Direct Replacement	Motorola Similar Replacement	Page Number
1.2KE18A		1N6279A	4-17
1.2KE18CA		1.5KE22CA	4-17
1.2KE20A		1N6280A	4-17
1.2KE20CA		1.5KE24CA	4-17
1.2KE22A		1N6281A	4-17
1.2KE22CA		1.5KE27CA	4-17
1.2KE24A		1N6282A	4-17
1.2KE24CA		1.5KE30CA	4-17
1.2KE26A		1N6283A	4-17
1.2KE26CA		1.5KE33CA	4-17
1.2KE28A		1N6283A	4-17
1.2KE28CA		1.5KE33CA	4-17
1.2KE30A		1N6284A	4-17
1.2KE30CA		1.5KE36CA	4-17
1.2KE33A		1N6285A	4-17
1.2KE33CA		1.5KE39CA	4-17
1.2KE36A		1N6286A	4-17
1.2KE36CA		1.5KE43CA	4-17
1.2KE40A		1N6287A	4-17
1.2KE40CA		1.5KE47CA	4-17
1.2KE43A		1N6288A	4-17
1.2KE43CA		1.5KE51CA	4-17
1.2KE45A		1N6289A	4-17
1.2KE45CA		1.5KE56CA	4-17
1.2KE48A		1N6289A	4-17
1.2KE48CA		1.5KE56CA	4-17
1.2KE5.0A		1N6267A	4-17
1.2KE5.0CA		1.5KE6.8CA	4-17
1.2KE51A		1N6290A	4-17
1.2KE51CA		1.5KE62CA	4-17
1.2KE54A		1N6291A	4-17
1.2KE54CA		1.5KE68CA	4-17
1.2KE58A		1N6291A	4-17
1.2KE58CA		1.5KE68CA	4-17
1.2KE6.0A		1N6268A	4-17
1.2KE6.0CA		1.5KE7.5CA	4-17
1.2KE6.5A		1N6268A	4-17
1.2KE6.5CA		1.5KE7.5CA	4-17
1.2KE60A		1N6292A	4-17
1.2KE60CA		1.5KE75CA	4-17
1.2KE64A		1N6292A	4-17
1.2KE64CA		1.5KE75CA	4-17
1.2KE7.0A		1N6269A	4-17
1.2KE7.0CA		1.5KE8.2CA	4-17
1.2KE7.5A		1N6270A	4-17
1.2KE7.5CA		1.5KE9.1CA	4-17
1.2KE70A		1N6293A	4-17
1.2KE70CA		1.5KE82CA	4-17
1.2KE75A		1N6294A	4-17
1.2KE75CA		1.5KE91CA	4-17

CF = consult factory representative

**CROSS-REFERENCE (continued)**

Industry Part Number	Motorola Direct Replacement	Motorola Similar Replacement	Page Number
1.2KE78A		1N6294A	4-17
1.2KE78CA		1.5KE91CA	4-17
1.2KE8.0A		1N6271A	4-17
1.2KE8.0CA		1.5KE10CA	4-17
1.2KE8.5A		1N6271A	4-17
1.2KE8.5CA		1.5KE10CA	4-17
1.2KE85A		1N6295A	4-17
1.2KE85CA		1.5KE100CA	4-17
1.2KE9.0A		1N6272A	4-17
1.2KE9.0CA		1.5KE11CA	4-17
1.2KE90A		1N6296A	4-17
1.2KE90CA		1.5KE110CA	4-17
1.5KE10	1.5KE10A		4-17
1.5KE100	1.5KE100A		4-17
1.5KE100A	1.5KE100A		4-17
1.5KE100C	1.5KE100CA		4-17
1.5KE100CA	1.5KE100CA		4-17
1.5KE100CP		1.5KE100CA	4-17
1.5KE100P		1.5KE100A	4-17
1.5KE10A	1.5KE10A		4-17
1.5KE10C	1.5KE10CA		4-17
1.5KE10CA	1.5KE10CA		4-17
1.5KE10CP		1.5KE10CA	4-17
1.5KE10P		1.5KE10A	4-17
1.5KE11	1.5KE11A		4-17
1.5KE110	1.5KE110A		4-17
1.5KE110A	1.5KE110A		4-17
1.5KE110C	1.5KE110CA		4-17
1.5KE110CA	1.5KE110CA		4-17
1.5KE110CP		1.5KE110CA	4-17
1.5KE110P		1.5KE110A	4-17
1.5KE11A	1.5KE11A		4-17
1.5KE11C	1.5KE11CA		4-17
1.5KE11CA	1.5KE11CA		4-17
1.5KE11CP		1.5KE11CA	4-17
1.5KE11P		1.5KE11A	4-17
1.5KE12	1.5KE12A		4-17
1.5KE120	1.5KE120A		4-17
1.5KE120A	1.5KE120A		4-17
1.5KE120C	1.5KE120CA		4-17
1.5KE120CA	1.5KE120CA		4-17
1.5KE120CP		1.5KE120CA	4-17
1.5KE120P		1.5KE120A	4-17
1.5KE12A	1.5KE12A		4-17
1.5KE12C	1.5KE12CA		4-17
1.5KE12CA	1.5KE12CA		4-17
1.5KE12CP		1.5KE12CA	4-17
1.5KE12P		1.5KE12A	4-17
1.5KE13	1.5KE13A		4-17
1.5KE130	1.5KE130A		4-17

Industry Part Number	Motorola Direct Replacement	Motorola Similar Replacement	Page Number
1.5KE130A	1.5KE130A		4-17
1.5KE130C	1.5KE130CA		4-17
1.5KE130CA	1.5KE130CA		4-17
1.5KE130CP		1.5KE130CA	4-17
1.5KE130P		1.5KE130A	4-17
1.5KE13A	1.5KE13A		4-17
1.5KE13C	1.5KE13CA		4-17
1.5KE13CA	1.5KE13CA		4-17
1.5KE13CP		1.5KE13CA	4-17
1.5KE13P		1.5KE13A	4-17
1.5KE15	1.5KE15A		4-17
1.5KE150	1.5KE150A		4-17
1.5KE150A	1.5KE150A		4-17
1.5KE150C	1.5KE150CA		4-17
1.5KE150CA	1.5KE150CA		4-17
1.5KE150CP		1.5KE150CA	4-17
1.5KE150P		1.5KE150A	4-17
1.5KE15A	1.5KE15A		4-17
1.5KE15C	1.5KE15CA		4-17
1.5KE15CA	1.5KE15CA		4-17
1.5KE15CP		1.5KE15CA	4-17
1.5KE15P		1.5KE15A	4-17
1.5KE16	1.5KE16A		4-17
1.5KE160	1.5KE160A		4-17
1.5KE160A	1.5KE160A		4-17
1.5KE160C	1.5KE160CA		4-17
1.5KE160CA	1.5KE160CA		4-17
1.5KE160CP		1.5KE160CA	4-17
1.5KE160P		1.5KE160A	4-17
1.5KE16A	1.5KE16A		4-17
1.5KE16C	1.5KE16CA		4-17
1.5KE16CA	1.5KE16CA		4-17
1.5KE16CP		1.5KE16CA	4-17
1.5KE16P		1.5KE16A	4-17
1.5KE170	1.5KE170A		4-17
1.5KE170A	1.5KE170A		4-17
1.5KE170C	1.5KE170CA		4-17
1.5KE170CA	1.5KE170CA		4-17
1.5KE170CP		1.5KE170CA	4-17
1.5KE170P		1.5KE170A	4-17
1.5KE18	1.5KE18A		4-17
1.5KE180	1.5KE180A		4-17
1.5KE180A	1.5KE180A		4-17
1.5KE180C	1.5KE180CA		4-17
1.5KE180CA	1.5KE180CA		4-17
1.5KE180CP		1.5KE180CA	4-17
1.5KE180P		1.5KE180A	4-17
1.5KE18A	1.5KE18A		4-17
1.5KE18C	1.5KE18CA		4-17
1.5KE18CA	1.5KE18CA		4-17

CF = consult factory representative



**CROSS-REFERENCE (continued)**

Industry Part Number	Motorola Direct Replacement	Motorola Similar Replacement	Page Number
1.5KE18CP		1.5KE18CA	4-17
1.5KE18P		1.5KE18A	4-17
1.5KE20	1.5KE20A		4-17
1.5KE200	1.5KE200A		4-17
1.5KE200A	1.5KE200A		4-17
1.5KE200C	1.5KE200CA		4-17
1.5KE200CA	1.5KE200CA		4-17
1.5KE200CP		1.5KE200CA	4-17
1.5KE200P		1.5KE200A	4-17
1.5KE20A	1.5KE20A		4-17
1.5KE20C	1.5KE20CA		4-17
1.5KE20CA	1.5KE20CA		4-17
1.5KE20CP		1.5KE20CA	4-17
1.5KE20P		1.5KE20A	4-17
1.5KE22	1.5KE22A		4-17
1.5KE220	1.5KE220A		4-17
1.5KE220A	1.5KE220A		4-17
1.5KE220C	1.5KE220CA		4-17
1.5KE220CA	1.5KE220CA		4-17
1.5KE220CP		1.5KE220CA	4-17
1.5KE220P		1.5KE220A	4-17
1.5KE22A	1.5KE22A		4-17
1.5KE22C	1.5KE22CA		4-17
1.5KE22CA	1.5KE22CA		4-17
1.5KE22CP		1.5KE22CA	4-17
1.5KE22P		1.5KE22A	4-17
1.5KE24	1.5KE24A		4-17
1.5KE24A	1.5KE24A		4-17
1.5KE24C	1.5KE24CA		4-17
1.5KE24CA	1.5KE24CA		4-17
1.5KE24CP		1.5KE24CA	4-17
1.5KE24P		1.5KE24A	4-17
1.5KE250	1.5KE250A		4-17
1.5KE250A	1.5KE250A		4-17
1.5KE250C	1.5KE250CA		4-17
1.5KE250CA	1.5KE250CA		4-17
1.5KE250CP		1.5KE250CA	4-17
1.5KE250P		1.5KE250A	4-17
1.5KE27	1.5KE27A		4-17
1.5KE27A	1.5KE27A		4-17
1.5KE27C	1.5KE27CA		4-17
1.5KE27CA	1.5KE27CA		4-17
1.5KE27CP		1.5KE27CA	4-17
1.5KE27P		1.5KE27A	4-17
1.5KE30	1.5KE30A		4-17
1.5KE30A	1.5KE30A		4-17
1.5KE30C	1.5KE30CA		4-17
1.5KE30CA	1.5KE30CA		4-17
1.5KE30CP		1.5KE30CA	4-17
1.5KE30P		1.5KE30A	4-17

Industry Part Number	Motorola Direct Replacement	Motorola Similar Replacement	Page Number
1.5KE33	1.5KE33A		4-17
1.5KE33A	1.5KE33A		4-17
1.5KE33C	1.5KE33CA		4-17
1.5KE33CA	1.5KE33CA		4-17
1.5KE33CP		1.5KE33CA	4-17
1.5KE33P		1.5KE33A	4-17
1.5KE36	1.5KE36A		4-17
1.5KE36A	1.5KE36A		4-17
1.5KE36C	1.5KE36CA		4-17
1.5KE36CA	1.5KE36CA		4-17
1.5KE36CP		1.5KE36CA	4-17
1.5KE36P		1.5KE36A	4-17
1.5KE39	1.5KE39A		4-17
1.5KE39A	1.5KE39A		4-17
1.5KE39C	1.5KE39CA		4-17
1.5KE39CA	1.5KE39CA		4-17
1.5KE39CP		1.5KE39CA	4-17
1.5KE39P		1.5KE39A	4-17
1.5KE43	1.5KE43A		4-17
1.5KE43A	1.5KE43A		4-17
1.5KE43C	1.5KE43CA		4-17
1.5KE43CA	1.5KE43CA		4-17
1.5KE43CP		1.5KE43CA	4-17
1.5KE43P		1.5KE43A	4-17
1.5KE47	1.5KE47A		4-17
1.5KE47A	1.5KE47A		4-17
1.5KE47C	1.5KE47CA		4-17
1.5KE47CA	1.5KE47CA		4-17
1.5KE47CP		1.5KE47CA	4-17
1.5KE47P		1.5KE47A	4-17
1.5KE51	1.5KE51A		4-17
1.5KE51A	1.5KE51A		4-17
1.5KE51C	1.5KE51CA		4-17
1.5KE51CA	1.5KE51CA		4-17
1.5KE51CP		1.5KE51CA	4-17
1.5KE51P		1.5KE51A	4-17
1.5KE56	1.5KE56A		4-17
1.5KE56A	1.5KE56A		4-17
1.5KE56C	1.5KE56CA		4-17
1.5KE56CA	1.5KE56CA		4-17
1.5KE56CP		1.5KE56CA	4-17
1.5KE56P		1.5KE56A	4-17
1.5KE6.8	1.5KE6.8A		4-17
1.5KE6.8A	1.5KE6.8A		4-17
1.5KE6.8C	1.5KE6.8CA		4-17
1.5KE6.8CA	1.5KE6.8CA		4-17
1.5KE62	1.5KE62A		4-17
1.5KE62A	1.5KE62A		4-17
1.5KE62C	1.5KE62CA		4-17
1.5KE62CA	1.5KE62CA		4-17

CF = consult factory representative

**CROSS-REFERENCE (continued)**

Industry Part Number	Motorola Direct Replacement	Motorola Similar Replacement	Page Number
1.5KE62CP		1.5KE62CA	4-17
1.5KE62P		1.5KE62A	4-17
1.5KE68	1.5KE68A		4-17
1.5KE68A	1.5KE68A		4-17
1.5KE68C	1.5KE68CA		4-17
1.5KE68CA	1.5KE68CA		4-17
1.5KE68CP		1.5KE68CA	4-17
1.5KE68P		1.5KE68A	4-17
1.5KE6V8A		1.5KE6.8A	4-17
1.5KE6V8CA		1.5KE6.8CA	4-17
1.5KE6V8CP		1.5KE6.8CA	4-17
1.5KE6V8P		1.5KE6.8A	4-17
1.5KE7.5	1.5KE7.5A		4-17
1.5KE7.5A	1.5KE7.5A		4-17
1.5KE7.5C	1.5KE7.5CA		4-17
1.5KE7.5CA	1.5KE7.5CA		4-17
1.5KE75	1.5KE75A		4-17
1.5KE75A	1.5KE75A		4-17
1.5KE75C	1.5KE75CA		4-17
1.5KE75CA	1.5KE75CA		4-17
1.5KE75CP		1.5KE75CA	4-17
1.5KE75P		1.5KE75A	4-17
1.5KE7V5A		1.5KE7.5A	4-17
1.5KE7V5CA		1.5KE7.5CA	4-17
1.5KE7V5CP		1.5KE7.5CA	4-17
1.5KE7V5P		1.5KE7.5A	4-17
1.5KE8.2	1.5KE8.2A		4-17
1.5KE8.2A	1.5KE8.2A		4-17
1.5KE8.2C	1.5KE8.2CA		4-17
1.5KE8.2CA	1.5KE8.2CA		4-17
1.5KE82	1.5KE82A		4-17
1.5KE82A	1.5KE82A		4-17
1.5KE82C	1.5KE82CA		4-17
1.5KE82CA	1.5KE82CA		4-17
1.5KE82CP		1.5KE82CA	4-17
1.5KE82P		1.5KE82A	4-17
1.5KE8V2A		1.5KE8.2A	4-17
1.5KE8V2CA		1.5KE8.2CA	4-17
1.5KE8V2CP		1.5KE8.2CA	4-17
1.5KE8V2P		1.5KE8.2A	4-17
1.5KE9.1	1.5KE9.1A		4-17
1.5KE9.1A	1.5KE9.1A		4-17
1.5KE9.1C	1.5KE9.1CA		4-17
1.5KE9.1CA	1.5KE9.1CA		4-17
1.5KE91	1.5KE91A		4-17
1.5KE91A	1.5KE91A		4-17
1.5KE91C	1.5KE91CA		4-17
1.5KE91CA	1.5KE91CA		4-17
1.5KE91CP		1.5KE91CA	4-17
1.5KE91P		1.5KE91A	4-17

Industry Part Number	Motorola Direct Replacement	Motorola Similar Replacement	Page Number
1.5KE9V1A		1.5KE9.1A	4-17
1.5KE9V1CA		1.5KE9.1CA	4-17
1.5KE9V1CP		1.5KE9.1CA	4-17
1.5KE9V1P		1.5KE9.1A	4-17
1.5R200		1N5956B	6-31
1.5R200A		1N5956B	6-31
1.5R200B		1N5956B	6-31
1.5R6.8		1N5921B	6-31
1.5R6.8A		1N5921B	6-31
1.5R6.8B		1N5921B	6-31
1.5SMC10AT3	1.5SMC10AT3		5-23
1.5SMC11AT3	1.5SMC11AT3		5-23
1.5SMC12AT3	1.5SMC12AT3		5-23
1.5SMC13AT3	1.5SMC13AT3		5-23
1.5SMC15AT3	1.5SMC15AT3		5-23
1.5SMC16AT3	1.5SMC16AT3		5-23
1.5SMC18AT3	1.5SMC18AT3		5-23
1.5SMC20AT3	1.5SMC20AT3		5-23
1.5SMC22AT3	1.5SMC22AT3		5-23
1.5SMC24AT3	1.5SMC24AT3		5-23
1.5SMC27AT3	1.5SMC27AT3		5-23
1.5SMC30AT3	1.5SMC30AT3		5-23
1.5SMC33AT3	1.5SMC33AT3		5-23
1.5SMC36AT3	1.5SMC36AT3		5-23
1.5SMC39AT3	1.5SMC39AT3		5-23
1.5SMC43AT3	1.5SMC43AT3		5-23
1.5SMC47AT3	1.5SMC47AT3		5-23
1.5SMC51AT3	1.5SMC51AT3		5-23
1.5SMC56AT3	1.5SMC56AT3		5-23
1.5SMC6.8AT3	1.5SMC6.8AT3		5-23
1.5SMC62AT3	1.5SMC62AT3		5-23
1.5SMC68AT3	1.5SMC68AT3		5-23
1.5SMC7.5AT3	1.5SMC7.5AT3		5-23
1.5SMC75AT3	1.5SMC75AT3		5-23
1.5SMC8.2AT3	1.5SMC8.2AT3		5-23
1.5SMC82AT3	1.5SMC82AT3		5-23
1.5SMC9.1AT3	1.5SMC9.1AT3		5-23
1.5SMC91AT3	1.5SMC91AT3		5-23
1/2R200		1N5281B	6-12
1/2R200A		1N5281B	6-12
1/2R200B		1N5281B	6-12
1/2R6.8		1N5235B	6-11
1/2R6.8A		1N5235B	6-11
1/2R6.8B		1N5235B	6-11
1/4LZ2.2D		1N5221B	6-11
1/4LZ2.2D10		1N5221B	6-11
1/4LZ2.2D5		1N5221B	6-11
1/4LZ6.8D		1N5235B	6-11
1/4LZ6.8D10		1N5235B	6-11
1/4LZ6.8D5		1N5235B	6-11

CF = consult factory representative

**CROSS-REFERENCE (continued)**

Industry Part Number	Motorola Direct Replacement	Motorola Similar Replacement	Page Number
1/4M100Z10		1N5271B	6-12
1/4M100Z5		1N5271B	6-12
1/4M105Z10		1N5272B	6-12
1/4M105Z5		1N5272B	6-12
1/4M10Z10		1N5240B	6-11
1/4M10Z5		1N5240B	6-11
1/4M110Z10		1N5272B	6-12
1/4M110Z5		1N5272B	6-12
1/4M11Z10		1N5241B	6-11
1/4M11Z5		1N5241B	6-11
1/4M120Z10		1N5273B	6-12
1/4M120Z5		1N5273B	6-12
1/4M12Z10		1N5242B	6-11
1/4M12Z5		1N5242B	6-11
1/4M130Z10		1N5274B	6-12
1/4M130Z5		1N5274B	6-12
1/4M13Z10		1N5243B	6-11
1/4M13Z5		1N5243B	6-11
1/4M140Z10		1N5275B	6-12
1/4M140Z5		1N5275B	6-12
1/4M14Z10		1N5244B	6-11
1/4M14Z5		1N5244B	6-11
1/4M150Z10		1N5276B	6-12
1/4M150Z5		1N5276B	6-12
1/4M15Z10		1N5245B	6-11
1/4M15Z5		1N5245B	6-11
1/4M16Z10		1N5246B	6-11
1/4M16Z5		1N5246B	6-11
1/4M175Z10		1N5279B	6-12
1/4M175Z5		1N5279B	6-12
1/4M17Z10		1N5247B	6-11
1/4M17Z5		1N5247B	6-11
1/4M18Z10		1N5248B	6-11
1/4M18Z5		1N5248B	6-11
1/4M19Z10		1N5249B	6-11
1/4M19Z5		1N5249B	6-11
1/4M2.4AZ10		1N5222B	6-11
1/4M2.4AZ5		1N5222B	6-11
1/4M2.7AZ10		1N5224B	6-11
1/4M2.7AZ5		1N5224B	6-11
1/4M200Z10		1N5281B	6-12
1/4M200Z5		1N5281B	6-12
1/4M20Z10		1N5250B	6-11
1/4M20Z5		1N5250B	6-11
1/4M22Z10		1N5251B	6-11
1/4M22Z5		1N5251B	6-11
1/4M24Z10		1N5252B	6-11
1/4M24Z5		1N5252B	6-11
1/4M25Z10		1N5253B	6-11
1/4M25Z5		1N5253B	6-11

Industry Part Number	Motorola Direct Replacement	Motorola Similar Replacement	Page Number
1/4M27Z10		1N5254B	6-11
1/4M27Z5		1N5254B	6-11
1/4M3.0AZ10		1N5225B	6-11
1/4M3.0AZ5		1N5225B	6-11
1/4M3.3AZ10		1N5226B	6-11
1/4M3.3AZ5		1N5226B	6-11
1/4M3.6AZ10		1N5227B	6-11
1/4M3.6AZ5		1N5227B	6-11
1/4M3.9AZ10		1N5228B	6-11
1/4M3.9AZ5		1N5228B	6-11
1/4M30Z10		1N5256B	6-11
1/4M30Z5		1N5256B	6-11
1/4M33Z10		1N5257B	6-11
1/4M33Z5		1N5257B	6-11
1/4M36Z10		1N5258B	6-11
1/4M36Z5		1N5258B	6-11
1/4M39Z10		1N5259B	6-11
1/4M39Z5		1N5259B	6-11
1/4M4.3AZ10		1N5229B	6-11
1/4M4.3AZ5		1N5229B	6-11
1/4M4.7AZ10		1N5230B	6-11
1/4M4.7AZ5		1N5230B	6-11
1/4M43Z10		1N5260B	6-11
1/4M43Z5		1N5260B	6-11
1/4M45Z10		1N5261B	6-11
1/4M45Z5		1N5261B	6-11
1/4M47Z10		1N5261B	6-11
1/4M47Z5		1N5261B	6-11
1/4M5.1AZ10		1N5231B	6-11
1/4M5.1AZ5		1N5231B	6-11
1/4M5.6AZ10		1N5232B	6-11
1/4M5.6AZ5		1N5232B	6-11
1/4M50Z10		1N5262B	6-11
1/4M50Z5		1N5262B	6-11
1/4M52Z10		1N5262B	6-11
1/4M52Z5		1N5262B	6-11
1/4M56Z10		1N5263B	6-11
1/4M56Z5		1N5263B	6-11
1/4M6.2AZ10		1N5234B	6-11
1/4M6.2AZ5		1N5234B	6-11
1/4M6.8Z10		1N5234B	6-11
1/4M6.8Z5		1N5234B	6-11
1/4M62Z10		1N5265B	6-11
1/4M62Z5		1N5265B	6-11
1/4M68Z10		1N5266B	6-12
1/4M68Z5		1N5266B	6-12
1/4M7.5Z10		1N5236B	6-11
1/4M7.5Z5		1N5236B	6-11
1/4M75Z10		1N5267B	6-12
1/4M75Z5		1N5267B	6-12

CF = consult factory representative

**CROSS-REFERENCE (continued)**

Industry Part Number	Motorola Direct Replacement	Motorola Similar Replacement	Page Number
1/4M8.2Z10		1N5237B	6-11
1/4M8.2Z5		1N5237B	6-11
1/4M82Z10		1N5268B	6-12
1/4M82Z5		1N5268B	6-12
1/4M9.1Z10		1N5239B	6-11
1/4M9.1Z5		1N5239B	6-11
1/4M91Z10		1N5270B	6-12
1/4M91Z5		1N5270B	6-12
1/4Z110D		1N5272B	6-12
1/4Z110D10		1N5272B	6-12
1/4Z110D5		1N5272B	6-12
1/4Z6.8D		1N5235B	6-11
1/4Z6.8D10		1N5235B	6-11
1/4Z6.8D5		1N5235B	6-11
1M110ZS10	1M110ZS5		6-36
1M110ZS5	1M110ZS5		6-36
1M120ZS10	1M120ZS5		6-36
1M120ZS5	1M120ZS5		6-36
1M130ZS10	1M130ZS5		6-36
1M130ZS5	1M130ZS5		6-36
1M150ZS10	1M150ZS5		6-36
1M150ZS5	1M150ZS5		6-36
1M160ZS10	1M160ZS5		6-36
1M160ZS5	1M160ZS5		6-36
1M180ZS10	1M180ZS5		6-36
1M180ZS5	1M180ZS5		6-36
1M200ZS10	1M200ZS5		6-36
1M200ZS5	1M200ZS5		6-36
1N1313		MZ4102	6-17
1N1313A		MZ4102	6-17
1N1314		1N4697	6-10
1N1314A		1N4697	6-10
1N1315		1N4700	6-10
1N1315A		1N4700	6-10
1N1316		1N4703	6-10
1N1316A		1N4703	6-10
1N1317		1N4706	6-10
1N1317A		1N4706	6-10
1N1318		1N4709	6-10
1N1318A		1N4709	6-10
1N1319		1N4712	6-10
1N1319A		1N4712	6-10
1N1320		1N4715	6-10
1N1320A		1N4715	6-10
1N1321		1N4717	6-10
1N1321A		1N4717	6-10
1N1425		1N4738A	6-24
1N1426		1N4742A	6-24
1N1427		1N4744A	6-24
1N1428		1N4746A	6-24

Industry Part Number	Motorola Direct Replacement	Motorola Similar Replacement	Page Number
1N1429		1N4748A	6-24
1N1430		1N4750A	6-24
1N1431		1N4760A	6-24
1N1432		1N4764A	6-24
1N1484		1N4732A	6-24
1N1485		1N4735A	6-24
1N1507		1N4730A	6-24
1N1507A		1N4730A	6-24
1N1508		1N4732A	6-24
1N1508A		1N4732A	6-24
1N1509		1N4734A	6-24
1N1509A		1N4734A	6-24
1N1510		1N4736A	6-24
1N1510A		1N4736A	6-24
1N1511		1N4738A	6-24
1N1511A		1N4738A	6-24
1N1512		1N4740A	6-24
1N1512A		1N4740A	6-24
1N1513		1N4742A	6-24
1N1513A		1N4742A	6-24
1N1514		1N4744A	6-24
1N1514A		1N4744A	6-24
1N1515		1N4746A	6-24
1N1515A		1N4746A	6-24
1N1516		1N4748A	6-24
1N1516A		1N4748A	6-24
1N1517		1N4750A	6-24
1N1517A		1N4750A	6-24
1N1518		1N4730A	6-24
1N1518A		1N4730A	6-24
1N1519		1N4732A	6-24
1N1519A		1N4732A	6-24
1N1520		1N4734A	6-24
1N1520A		1N4734A	6-24
1N1521		1N4736A	6-24
1N1521A		1N4736A	6-24
1N1522		1N4738A	6-24
1N1522A		1N4738A	6-24
1N1523		1N4740A	6-24
1N1523A		1N4740A	6-24
1N1524		1N4742A	6-24
1N1524A		1N4742A	6-24
1N1525		1N4744A	6-24
1N1525A		1N4744A	6-24
1N1526		1N4746A	6-24
1N1526A		1N4746A	6-24
1N1527		1N4748A	6-24
1N1527A		1N4748A	6-24
1N1528		1N4750A	6-24
1N1528A		1N4750A	6-24

CF = consult factory representative

**CROSS-REFERENCE (continued)**

Industry Part Number	Motorola Direct Replacement	Motorola Similar Replacement	Page Number
1N1735		1N823	8-2
1N1744		1N4740A	6-24
1N1765		1N4734A	6-24
1N1765A		1N4734A	6-24
1N1766		1N4735A	6-24
1N1766A		1N4735A	6-24
1N1767		1N4736A	6-24
1N1767A		1N4736A	6-24
1N1768		1N4737A	6-24
1N1768A		1N4737A	6-24
1N1769		1N4738A	6-24
1N1769A		1N4738A	6-24
1N1770		1N4739A	6-24
1N1770A		1N4739A	6-24
1N1771		1N4740A	6-24
1N1771A		1N4740A	6-24
1N1772		1N4741A	6-24
1N1772A		1N4741A	6-24
1N1773		1N4742A	6-24
1N1773A		1N4742A	6-24
1N1774		1N4743A	6-24
1N1774A		1N4743A	6-24
1N1775		1N4744A	6-24
1N1775A		1N4744A	6-24
1N1776		1N4745A	6-24
1N1776A		1N4745A	6-24
1N1777		1N4746A	6-24
1N1777A		1N4746A	6-24
1N1778		1N4747A	6-24
1N1778A		1N4747A	6-24
1N1779		1N4748A	6-24
1N1779A		1N4748A	6-24
1N1780		1N4749A	6-24
1N1780A		1N4749A	6-24
1N1781		1N4750A	6-24
1N1781A		1N4750A	6-24
1N1782		1N4751A	6-24
1N1782A		1N4751A	6-24
1N1783		1N4752A	6-24
1N1783A		1N4752A	6-24
1N1784		1N4753A	6-24
1N1784A		1N4753A	6-24
1N1785		1N4754A	6-24
1N1785A		1N4754A	6-24
1N1786		1N4755A	6-24
1N1786A		1N4755A	6-24
1N1787		1N4756A	6-24
1N1787A		1N4756A	6-24
1N1788		1N4757A	6-24
1N1788A		1N4757A	6-24

Industry Part Number	Motorola Direct Replacement	Motorola Similar Replacement	Page Number
1N1789		1N4758A	6-24
1N1789A		1N4758A	6-24
1N1790		1N4759A	6-24
1N1790A		1N4759A	6-24
1N1791		1N4760A	6-24
1N1791A		1N4760A	6-24
1N1792		1N4761A	6-24
1N1792A		1N4761A	6-24
1N1793		1N4762A	6-24
1N1793A		1N4762A	6-24
1N1794		1N4763A	6-24
1N1794A		1N4763A	6-24
1N1795		1N4764A	6-24
1N1795A		1N4764A	6-24
1N1796		1M110ZS5	6-36
1N1796A		1M110ZS5	6-36
1N1797		1M120ZS5	6-36
1N1797A		1M120ZS5	6-36
1N1798		1M130ZS5	6-36
1N1798A		1M130ZS5	6-36
1N1799		1M150ZS5	6-36
1N1799A		1M150ZS5	6-36
1N1800		1M160ZS5	6-36
1N1800A		1M160ZS5	6-36
1N1801		1M180ZS5	6-36
1N1801A		1M180ZS5	6-36
1N1802		1M200ZS5	6-36
1N1802A		1M200ZS5	6-36
1N1876		1N4740A	6-24
1N1877		1N4742A	6-24
1N1878		1N4744A	6-24
1N1879		1N4746A	6-24
1N1880		1N4748A	6-24
1N1881		1N4750A	6-24
1N1882		1N4752A	6-24
1N1883		1N4754A	6-24
1N1884		1N4756A	6-24
1N1885		1N4758A	6-24
1N1886		1N4760A	6-24
1N1887		1N4762A	6-24
1N1888		1N4764A	6-24
1N1927		1N5228B	6-11
1N1928		1N5230B	6-11
1N1929		1N5232B	6-11
1N1930		1N5235B	6-11
1N1931		1N5237B	6-11
1N1932		1N5240B	6-11
1N1933		1N5242B	6-11
1N1934		1N5245B	6-11
1N1935		1N5248B	6-11

CF = consult factory representative

**CROSS-REFERENCE (continued)**

Industry Part Number	Motorola Direct Replacement	Motorola Similar Replacement	Page Number
1N1936		1N5251B	6-11
1N1937		1N5254B	6-11
1N1938		1N5257B	6-11
1N1939		1N5259B	6-11
1N1940		1N5261B	6-11
1N1941		1N5263B	6-11
1N1942		1N5266B	6-12
1N1943		1N5268B	6-12
1N1944		1N5271B	6-12
1N1945		1N5273B	6-12
1N1946		1N5276B	6-12
1N1947		1N5279B	6-12
1N1954		1N5228B	6-11
1N1955		1N5230B	6-11
1N1956		1N5232B	6-11
1N1957		1N5235B	6-11
1N1958		1N5237B	6-11
1N1959		1N5240B	6-11
1N1960		1N5242B	6-11
1N1961		1N5245B	6-11
1N1962		1N5248B	6-11
1N1963		1N5251B	6-11
1N1964		1N5254B	6-11
1N1965		1N5257B	6-11
1N1966		1N5259B	6-11
1N1967		1N5261B	6-11
1N1968		1N5263B	6-11
1N1969		1N5266B	6-12
1N1970		1N5268B	6-12
1N1971		1N5271B	6-12
1N1972		1N5273B	6-12
1N1973		1N5276B	6-12
1N1974		1N5279B	6-12
1N1981		1N5228B	6-11
1N1982		1N5230B	6-11
1N1983		1N5232B	6-11
1N1984		1N5235B	6-11
1N1985		1N5237B	6-11
1N1986		1N5240B	6-11
1N1987		1N5242B	6-11
1N1988		1N5245B	6-11
1N1989		1N5248B	6-11
1N1990		1N5251B	6-11
1N1991		1N5254B	6-11
1N1992		1N5257B	6-11
1N1993		1N5259B	6-11
1N1994		1N5261B	6-11
1N1995		1N5263B	6-11
1N1996		1N5266B	6-12
1N1997		1N5268B	6-12

Industry Part Number	Motorola Direct Replacement	Motorola Similar Replacement	Page Number
1N1998		1N5271B	6-12
1N1999		1N5273B	6-12
1N2000		1N5276B	6-12
1N2001		1N5279B	6-12
1N2032		1N4733A	6-24
1N2032A		1N4733A	6-24
1N2033		1N4734A	6-24
1N2033A		1N4734A	6-24
1N2034		1N4736A	6-24
1N2034A		1N4736D	6-24
1N2035		1N4739A	6-24
1N2035A		1N4739D	6-24
1N2036		1N4741A	6-24
1N2036A		1N4741D	6-24
1N2037		1N4743A	6-24
1N2037A		1N4743D	6-24
1N2038		1N4745A	6-24
1N2038A		1N4745D	6-24
1N2039		1N4747A	6-24
1N2039A		1N4747D	6-24
1N2040		1N4749A	6-24
1N2040A		1N4749C	6-24
1N2387		1N4751A	6-24
1N2765		1N823A	8-2
1N2765A		1N825A	8-2
1N3016		MZP4736A	6-36
1N3016A		MZP4736A	6-36
1N3016B		MZP4736A	6-36
1N3017		MZP4737A	6-36
1N3017A		MZP4737A	6-36
1N3017B		MZP4737A	6-36
1N3018		MZP4738A	6-36
1N3018A		MZP4738A	6-36
1N3018B		MZP4738A	6-36
1N3019		MZP4739A	6-36
1N3019A		MZP4739A	6-36
1N3019B		MZP4739A	6-36
1N3020		MZP4740A	6-36
1N3020A		MZP4740A	6-36
1N3020B		MZP4740A	6-36
1N3021		MZP4741A	6-36
1N3021A		MZP4741A	6-36
1N3021B		MZP4741A	6-36
1N3022		MZP4742A	6-36
1N3022A		MZP4742A	6-36
1N3022B		MZP4742A	6-36
1N3023		MZP4743A	6-36
1N3023A		MZP4743A	6-36
1N3023B		MZP4743A	6-36
1N3024		MZP4744A	6-36

CF = consult factory representative

**CROSS-REFERENCE (continued)**

Industry Part Number	Motorola Direct Replacement	Motorola Similar Replacement	Page Number
1N3024A		MZP4744A	6-36
1N3024B		MZP4744A	6-36
1N3025		MZP4745A	6-36
1N3025A		MZP4745A	6-36
1N3025B		MZP4745A	6-36
1N3026		MZP4746A	6-36
1N3026A		MZP4746A	6-36
1N3026B		MZP4746A	6-36
1N3027		MZP4747A	6-36
1N3027A		MZP4747A	6-36
1N3027B		MZP4747A	6-36
1N3028		MZP4748A	6-36
1N3028A		MZP4748A	6-36
1N3028B		MZP4748A	6-36
1N3029		MZP4749A	6-36
1N3029A		MZP4749A	6-36
1N3029B		MZP4749A	6-36
1N3030		MZP4750A	6-36
1N3030A		MZP4750A	6-36
1N3030B		MZP4750A	6-36
1N3031		MZP4751A	6-36
1N3031A		MZP4751A	6-36
1N3031B		MZP4751A	6-36
1N3032		MZP4752A	6-36
1N3032A		MZP4752A	6-36
1N3032B		MZP4752A	6-36
1N3033		MZP4753A	6-36
1N3033A		MZP4753A	6-36
1N3033B		MZP4753A	6-36
1N3034		MZP4754A	6-36
1N3034A		MZP4754A	6-36
1N3034B		MZP4754A	6-36
1N3035		MZP4755A	6-36
1N3035A		MZP4755A	6-36
1N3035B		MZP4755A	6-36
1N3036		MZP4756A	6-36
1N3036A		MZP4756A	6-36
1N3036B		MZP4756A	6-36
1N3037		MZP4757A	6-36
1N3037A		MZP4757A	6-36
1N3037B		MZP4757A	6-36
1N3038		MZP4758A	6-36
1N3038A		MZP4758A	6-36
1N3038B		MZP4758A	6-36
1N3039		MZP4759A	6-36
1N3039A		MZP4759A	6-36
1N3039B		MZP4759A	6-36
1N3040		MZP4760A	6-36
1N3040A		MZP4760A	6-36
1N3040B		MZP4760A	6-36

Industry Part Number	Motorola Direct Replacement	Motorola Similar Replacement	Page Number
1N3041		MZP4761A	6-36
1N3041A		MZP4761A	6-36
1N3041B		MZP4761A	6-36
1N3042		MZP4762A	6-36
1N3042A		MZP4762A	6-36
1N3042B		MZP4762A	6-36
1N3043		MZP4763A	6-36
1N3043A		MZP4763A	6-36
1N3043B		MZP4763A	6-36
1N3044		MZP4764A	6-36
1N3044A		MZP4764A	6-36
1N3044B		MZP4764A	6-36
1N3045		1M110ZS5	6-36
1N3045A		1M110ZS5	6-36
1N3045B		1M110ZS5	6-36
1N3046		1M120ZS5	6-36
1N3046A		1M120ZS5	6-36
1N3046B		1M120ZS5	6-36
1N3047		1M130ZS5	6-36
1N3047A		1M130ZS5	6-36
1N3047B		1M130ZS5	6-36
1N3048		1M150ZS5	6-36
1N3048A		1M150ZS5	6-36
1N3048B		1M150ZS5	6-36
1N3049		1M160ZS5	6-36
1N3049A		1M160ZS5	6-36
1N3049B		1M160ZS5	6-36
1N3050		1M180ZS5	6-36
1N3050A		1M180ZS5	6-36
1N3050B		1M180ZS5	6-36
1N3051		1M200ZS5	6-36
1N3051A		1M200ZS5	6-36
1N3051B		1M200ZS5	6-36
1N3098		1M120ZS5	6-36
1N3098A		1M120ZS5	6-36
1N3099		1M150ZS5	6-36
1N3099A		1M150ZS5	6-36
1N3100		1M180ZS5	6-36
1N3100A		1M180ZS5	6-36
1N3101		1M200ZS5	6-36
1N3101A		1M200ZS5	6-36
1N3112		1N4737A	6-24
1N3181		1N5237B	6-11
1N3198		1N5221B	6-11
1N3411		1N5234B	6-11
1N3412		1N5235B	6-11
1N3413		1N5236B	6-11
1N3414		1N5237B	6-11
1N3415		1N5240B	6-11
1N3416		1N5242B	6-11

CF = consult factory representative

**CROSS-REFERENCE (continued)**

Industry Part Number	Motorola Direct Replacement	Motorola Similar Replacement	Page Number
1N3417		1N5245B	6-11
1N3418		1N5248B	6-11
1N3419		1N5251B	6-11
1N3420		1N5254B	6-11
1N3421		1N5256B	6-11
1N3422		1N5257B	6-11
1N3423		1N5259B	6-11
1N3424		1N5261B	6-11
1N3425		1N5263B	6-11
1N3426		1N5266B	6-12
1N3427		1N5268B	6-12
1N3428		1N5271B	6-12
1N3429		1N5273B	6-12
1N3430		1N5276B	6-12
1N3431		1N5279B	6-12
1N3432		1N5281B	6-12
1N3443		3EZ6.2D5	6-33
1N3444		3EZ6.8D5	6-33
1N3445		3EZ8.2D5	6-33
1N3446		3EZ10D5	6-33
1N3447		3EZ12D5	6-33
1N3448		3EZ15D5	6-33
1N3449		3EZ18D5	6-33
1N3450		3EZ22D5	6-33
1N3451		3EZ27D5	6-33
1N3452		3EZ30D5	6-33
1N3453		3EZ33D5	6-33
1N3454		3EZ39D5	6-33
1N3455		3EZ47D5	6-33
1N3456		3EZ56D5	6-33
1N3457		3EZ68D5	6-33
1N3458		3EZ82D5	6-33
1N3459		3EZ100D5	6-33
1N3460		3EZ120D5	6-33
1N3461		3EZ150D5	6-33
1N3462		3EZ180D5	6-33
1N3463		3EZ220D5	6-34
1N3477		1N5985B	6-13
1N3477A		1N5985B	6-13
1N3506		1N5226B	6-11
1N3507		1N5227B	6-11
1N3508		1N5228B	6-11
1N3509		1N5229B	6-11
1N3510		1N5230B	6-11
1N3511		1N5231B	6-11
1N3512		1N5232B	6-11
1N3513		1N5234B	6-11
1N3514		1N5235B	6-11
1N3515		1N5236B	6-11
1N3516		1N5237B	6-11

Industry Part Number	Motorola Direct Replacement	Motorola Similar Replacement	Page Number
1N3517		1N5239B	6-11
1N3518		1N5240B	6-11
1N3519		1N5241B	6-11
1N3520		1N5242B	6-11
1N3521		1N5243B	6-11
1N3522		1N5245B	6-11
1N3523		1N5246B	6-11
1N3524		1N5248B	6-11
1N3525		1N5250B	6-11
1N3526		1N5251B	6-11
1N3527		1N5252B	6-11
1N3528		1N5254B	6-11
1N3529		1N5256B	6-11
1N3530		1N5257B	6-11
1N3531		1N5258B	6-11
1N3532		1N5259B	6-11
1N3533		1N5260B	6-11
1N3534		1N5261B	6-11
1N3553		1N821	8-2
1N3675		1N4736A	6-24
1N3675A		1N4736A	6-24
1N3675B		1N4736A	6-24
1N3676		1N4737A	6-24
1N3676A		1N4737A	6-24
1N3676B		1N4737A	6-24
1N3677		1N4738A	6-24
1N3677A		1N4738A	6-24
1N3677B		1N4738A	6-24
1N3678		1N4739A	6-24
1N3678A		1N4739A	6-24
1N3678B		1N4739A	6-24
1N3679		1N4740A	6-24
1N3679A		1N4740A	6-24
1N3679B		1N4740A	6-24
1N3680		1N4741A	6-24
1N3680A		1N4741A	6-24
1N3680B		1N4741A	6-24
1N3681		1N4742A	6-24
1N3681A		1N4742A	6-24
1N3681B		1N4742A	6-24
1N3682		1N4743A	6-24
1N3682A		1N4743A	6-24
1N3682B		1N4743A	6-24
1N3683		1N4744A	6-24
1N3683A		1N4744A	6-24
1N3683B		1N4744A	6-24
1N3684		1N4745A	6-24
1N3684A		1N4745A	6-24
1N3684B		1N4745A	6-24
1N3685		1N4746A	6-24

CF = consult factory representative



**CROSS-REFERENCE (continued)**

Industry Part Number	Motorola Direct Replacement	Motorola Similar Replacement	Page Number
1N3685A		1N4746A	6-24
1N3685B		1N4746A	6-24
1N3686		1N4747A	6-24
1N3686A		1N4747A	6-24
1N3686B		1N4747A	6-24
1N3687		1N4748A	6-24
1N3687A		1N4748A	6-24
1N3687B		1N4748A	6-24
1N3688		1N4749A	6-24
1N3688A		1N4749A	6-24
1N3688B		1N4749A	6-24
1N3689		1N4750A	6-24
1N3689A		1N4750A	6-24
1N3689B		1N4750A	6-24
1N3690		1N4751A	6-24
1N3690A		1N4751A	6-24
1N3690B		1N4751A	6-24
1N3691		1N4752A	6-24
1N3691A		1N4752A	6-24
1N3691B		1N4752A	6-24
1N3692		1N4753A	6-24
1N3692A		1N4753A	6-24
1N3692B		1N4753A	6-24
1N3693		1N4754A	6-24
1N3693A		1N4754A	6-24
1N3693B		1N4754A	6-24
1N3694		1N4755A	6-24
1N3694A		1N4755A	6-24
1N3694B		1N4755A	6-24
1N3695		1N4756A	6-24
1N3695A		1N4756A	6-24
1N3695B		1N4756A	6-24
1N3696		1N4757A	6-24
1N3696A		1N4757A	6-24
1N3696B		1N4757A	6-24
1N3697		1N4758A	6-24
1N3697A		1N4758A	6-24
1N3697B		1N4758A	6-24
1N3698		1N4759A	6-24
1N3698A		1N4759A	6-24
1N3698B		1N4759A	6-24
1N3699		1N4760A	6-24
1N3699A		1N4760A	6-24
1N3699B		1N4760A	6-24
1N370		1N5221B	6-11
1N3700		1N4761A	6-24
1N3700A		1N4761A	6-24
1N3700B		1N4761A	6-24
1N3701		1N4762A	6-24
1N3701A		1N4762A	6-24

Industry Part Number	Motorola Direct Replacement	Motorola Similar Replacement	Page Number
1N3701B		1N4762A	6-24
1N3702		1N4763A	6-24
1N3702A		1N4763A	6-24
1N3702B		1N4763A	6-24
1N3703		1N4764A	6-24
1N3703A		1N4764A	6-24
1N3703B		1N4764A	6-24
1N3704		1M110ZS5	6-36
1N3704A		1M110ZS5	6-36
1N3704B		1M110ZS5	6-36
1N3705		1M120ZS5	6-36
1N3705A		1M120ZS5	6-36
1N3705B		1M120ZS5	6-36
1N3706		1M130ZS5	6-36
1N3706A		1M130ZS5	6-36
1N3706B		1M130ZS5	6-36
1N3707		1M150ZS5	6-36
1N3707A		1M150ZS5	6-36
1N3707B		1M150ZS5	6-36
1N3708		1M160ZS5	6-36
1N3708A		1M160ZS5	6-36
1N3708B		1M160ZS5	6-36
1N3709		1M180ZS5	6-36
1N3709A		1M180ZS5	6-36
1N3709B		1M180ZS5	6-36
1N371		1N5221B	6-11
1N3710		1M200ZS5	6-36
1N3710A		1M200ZS5	6-36
1N3710B		1M200ZS5	6-36
1N372		1N5225B	6-11
1N373		1N5227B	6-11
1N374		1N5229B	6-11
1N375		1N5230B	6-11
1N376		1N5233B	6-11
1N377		1N5236B	6-11
1N378		1N5238B	6-11
1N3785		1N5921B	6-31
1N3785A		1N5921B	6-31
1N3785B		1N5921B	6-31
1N3786		1N5922B	6-31
1N3786A		1N5922B	6-31
1N3786B		1N5922B	6-31
1N3787		1N5923B	6-31
1N3787A		1N5923B	6-31
1N3787B		1N5923B	6-31
1N3788		1N5924B	6-31
1N3788A		1N5924B	6-31
1N3788B		1N5924B	6-31
1N3789		1N5925B	6-31
1N3789A		1N5925B	6-31

CF = consult factory representative

**CROSS-REFERENCE (continued)**

Industry Part Number	Motorola Direct Replacement	Motorola Similar Replacement	Page Number
1N3789B		1N5925B	6-31
1N379		1N5240B	6-11
1N3790		1N5926B	6-31
1N3790A		1N5926B	6-31
1N3790B		1N5926B	6-31
1N3791		1N5927B	6-31
1N3791A		1N5927B	6-31
1N3791B		1N5927B	6-31
1N3792		1N5928B	6-31
1N3792A		1N5928B	6-31
1N3792B		1N5928B	6-31
1N3793		1N5929B	6-31
1N3793A		1N5929B	6-31
1N3793B		1N5929B	6-31
1N3794		1N5930B	6-31
1N3794A		1N5930B	6-31
1N3794B		1N5930B	6-31
1N3795		1N5931B	6-31
1N3795A		1N5931B	6-31
1N3795B		1N5931B	6-31
1N3796		1N5932B	6-31
1N3796A		1N5932B	6-31
1N3796B		1N5932B	6-31
1N3797		1N5933B	6-31
1N3797A		1N5933B	6-31
1N3797B		1N5933B	6-31
1N3798		1N5934B	6-31
1N3798A		1N5934B	6-31
1N3798B		1N5934B	6-31
1N3799		1N5935B	6-31
1N3799A		1N5935B	6-31
1N3799B		1N5935B	6-31
1N380		1N5243B	6-11
1N3800		1N5936B	6-31
1N3800A		1N5936B	6-31
1N3800B		1N5936B	6-31
1N3801		1N5937B	6-31
1N3801A		1N5937B	6-31
1N3801B		1N5937B	6-31
1N3802		1N5938B	6-31
1N3802A		1N5938B	6-31
1N3802B		1N5938B	6-31
1N3803		1N5939B	6-31
1N3803A		1N5939B	6-31
1N3803B		1N5939B	6-31
1N3804		1N5940B	6-31
1N3804A		1N5940B	6-31
1N3804B		1N5940B	6-31
1N3805		1N5941B	6-31
1N3805A		1N5941B	6-31

Industry Part Number	Motorola Direct Replacement	Motorola Similar Replacement	Page Number
1N3805B		1N5941B	6-31
1N3806		1N5942B	6-31
1N3806A		1N5942B	6-31
1N3806B		1N5942B	6-31
1N3807		1N5943B	6-31
1N3807A		1N5943B	6-31
1N3807B		1N5943B	6-31
1N3808		1N5944B	6-31
1N3808A		1N5944B	6-31
1N3808B		1N5944B	6-31
1N3809		1N5945B	6-31
1N3809A		1N5945B	6-31
1N3809B		1N5945B	6-31
1N381		1N5246B	6-11
1N3810		1N5946B	6-31
1N3810A		1N5946B	6-31
1N3810B		1N5946B	6-31
1N3811		1N5947B	6-31
1N3811A		1N5947B	6-31
1N3811B		1N5947B	6-31
1N3812		1N5948B	6-31
1N3812A		1N5948B	6-31
1N3812B		1N5948B	6-31
1N3813		1N5949B	6-31
1N3813A		1N5949B	6-31
1N3813B		1N5949B	6-31
1N3814		1N5950B	6-31
1N3814A		1N5950B	6-31
1N3814B		1N5950B	6-31
1N3815		1N5951B	6-31
1N3815A		1N5951B	6-31
1N3815B		1N5951B	6-31
1N3816		1N5952B	6-31
1N3816A		1N5952B	6-31
1N3816B		1N5952B	6-31
1N3817		1N5953B	6-31
1N3817A		1N5953B	6-31
1N3817B		1N5953B	6-31
1N3818		1N5954B	6-31
1N3818A		1N5954B	6-31
1N3818B		1N5954B	6-31
1N3819		1N5955B	6-31
1N3819A		1N5955B	6-31
1N3819B		1N5955B	6-31
1N382		1N5249B	6-11
1N3820		1N5956B	6-31
1N3820A		1N5956B	6-31
1N3820B		1N5956B	6-31
1N3821		MZP4728A	6-36
1N3821A		MZP4728A	6-36

CF = consult factory representative

**CROSS-REFERENCE (continued)**

Industry Part Number	Motorola Direct Replacement	Motorola Similar Replacement	Page Number
1N3822		MZP4729A	6-36
1N3822A		MZP4729A	6-36
1N3823		MZP4730A	6-36
1N3823A		MZP4730A	6-36
1N3824		MZP4731A	6-36
1N3824A		MZP4731A	6-36
1N3825		MZP4732A	6-36
1N3825A		MZP4732A	6-36
1N3826		MZP4733A	6-36
1N3826A		MZP4733A	6-36
1N3827		MZP4734A	6-36
1N3827A		MZP4734A	6-36
1N3828		MZP4735A	6-36
1N3828A		MZP4735A	6-36
1N3829		MZP4736A	6-36
1N3829A		MZP4736A	6-36
1N383		1N5252B	6-11
1N3830		MZP4737A	6-36
1N3830A		MZP4737A	6-36
1N384		1N5255B	6-11
1N385		1N5258B	6-11
1N386		1N5260B	6-11
1N387		1N5261B	6-11
1N3951		1N5934B	6-31
1N4016		1N6269A	4-17
1N4016A		1N6269A	4-17
1N4016B		1N6269A	4-17
1N4017		1N6270A	4-17
1N4017A		1N6270A	4-17
1N4017B		1N6270A	4-17
1N4018		1N6271A	4-17
1N4018A		1N6271A	4-17
1N4018B		1N6271A	4-17
1N4019		1N6272A	4-17
1N4019A		1N6272A	4-17
1N4019B		1N6272A	4-17
1N4020		1N6273A	4-17
1N4020A		1N6273A	4-17
1N4020B		1N6273A	4-17
1N4021		1N6274A	4-17
1N4021A		1N6274A	4-17
1N4021B		1N6274A	4-17
1N4022		1N6275A	4-17
1N4022A		1N6275A	4-17
1N4022B		1N6275A	4-17
1N4023		1N6276A	4-17
1N4023A		1N6276A	4-17
1N4023B		1N6276A	4-17
1N4024		1N6277A	4-17
1N4024A		1N6277A	4-17

Industry Part Number	Motorola Direct Replacement	Motorola Similar Replacement	Page Number
1N4024B		1N6277A	4-17
1N4025		1N6278A	4-17
1N4025A		1N6278A	4-17
1N4025B		1N6278A	4-17
1N4026		1N6279A	4-17
1N4026A		1N6279A	4-17
1N4026B		1N6279A	4-17
1N4027		1N6280A	4-17
1N4027A		1N6280A	4-17
1N4027B		1N6280A	4-17
1N4028		1N6281A	4-17
1N4028A		1N6281A	4-17
1N4028B		1N6281A	4-17
1N4029		1N6282A	4-17
1N4029A		1N6282A	4-17
1N4029B		1N6282A	4-17
1N4030		1N6283A	4-17
1N4030A		1N6283A	4-17
1N4030B		1N6283A	4-17
1N4031		1N6284A	4-17
1N4031A		1N6284A	4-17
1N4031B		1N6284A	4-17
1N4032		1N6285A	4-17
1N4032A		1N6285A	4-17
1N4032B		1N6285A	4-17
1N4033		1N6286A	4-17
1N4033A		1N6286A	4-17
1N4033B		1N6286A	4-17
1N4034		1N6287A	4-17
1N4034A		1N6287A	4-17
1N4034B		1N6287A	4-17
1N4035		1N6288A	4-17
1N4035A		1N6288A	4-17
1N4035B		1N6288A	4-17
1N4036		1N6289A	4-17
1N4036A		1N6289A	4-17
1N4036B		1N6289A	4-17
1N4037		1N6290A	4-17
1N4037A		1N6290A	4-17
1N4037B		1N6290A	4-17
1N4038		1N6291A	4-17
1N4038A		1N6291A	4-17
1N4038B		1N6291A	4-17
1N4039		1N6292A	4-17
1N4039A		1N6292A	4-17
1N4039B		1N6292A	4-17
1N4040		1N6293A	4-17
1N4040A		1N6293A	4-17
1N4040B		1N6293A	4-17
1N4041		1N6294A	4-17

CF = consult factory representative

**CROSS-REFERENCE (continued)**

Industry Part Number	Motorola Direct Replacement	Motorola Similar Replacement	Page Number
1N4041A		1N6294A	4-17
1N4041B		1N6294A	4-17
1N4042		1N6295A	4-17
1N4042A		1N6295A	4-17
1N4042B		1N6295A	4-17
1N4095		1N5993B	6-13
1N4096		3EZ91D5	6-33
1N4097		3EZ100D5	6-33
1N4098		3EZ150D5	6-33
1N4099		MZ4099	6-17
1N4100		MZ4100	6-17
1N4101		MZ4101	6-17
1N4102		MZ4102	6-17
1N4103		MZ4103	6-17
1N4104		MZ4104	6-17
1N4105		1N4698	6-10
1N4106		1N4699	6-10
1N4107		1N4700	6-10
1N4108		1N4701	6-10
1N4109		1N4702	6-10
1N4110		1N4703	6-10
1N4111		1N4704	6-10
1N4112		1N4705	6-10
1N4113		1N4706	6-10
1N4114		1N4707	6-10
1N4115		1N4708	6-10
1N4116		1N4709	6-10
1N4117		1N4710	6-10
1N4118		1N4711	6-10
1N4119		1N4712	6-10
1N4120		1N4713	6-10
1N4121		1N4714	6-10
1N4122		1N4715	6-10
1N4123		1N4716	6-10
1N4124		1N4717	6-10
1N4125		1N5261B	6-11
1N4126		1N5262B	6-11
1N4127		1N5263B	6-11
1N4128		1N5264B	6-11
1N4129		1N5265B	6-11
1N4130		1N5266B	6-12
1N4131		1N5267B	6-12
1N4132		1N5268B	6-12
1N4133		1N5269B	6-12
1N4134		1N5270B	6-12
1N4135		1N5271B	6-12
1N4158		1N4736A	6-24
1N4158A		1N4736A	6-24
1N4158B		1N4736A	6-24
1N4159		1N4737A	6-24

Industry Part Number	Motorola Direct Replacement	Motorola Similar Replacement	Page Number
1N4159A		1N4737A	6-24
1N4159B		1N4737A	6-24
1N4160		1N4738A	6-24
1N4160A		1N4738A	6-24
1N4160B		1N4738A	6-24
1N4161		1N4739A	6-24
1N4161A		1N4739A	6-24
1N4161B		1N4739A	6-24
1N4162		1N4740A	6-24
1N4162A		1N4740A	6-24
1N4162B		1N4740A	6-24
1N4163		1N4741A	6-24
1N4163A		1N4741A	6-24
1N4163B		1N4741A	6-24
1N4164		1N4742A	6-24
1N4164A		1N4742A	6-24
1N4164B		1N4742A	6-24
1N4165		1N4743A	6-24
1N4165A		1N4743A	6-24
1N4165B		1N4743A	6-24
1N4166		1N4744A	6-24
1N4166A		1N4744A	6-24
1N4166B		1N4744A	6-24
1N4167		1N4745A	6-24
1N4167A		1N4745A	6-24
1N4167B		1N4745A	6-24
1N4168		1N4746A	6-24
1N4168A		1N4746A	6-24
1N4168B		1N4746A	6-24
1N4169		1N4747A	6-24
1N4169A		1N4747A	6-24
1N4169B		1N4747A	6-24
1N4170		1N4748A	6-24
1N4170A		1N4748A	6-24
1N4170B		1N4748A	6-24
1N4171		1N4749A	6-24
1N4171A		1N4749A	6-24
1N4171B		1N4749A	6-24
1N4172		1N4750A	6-24
1N4172A		1N4750A	6-24
1N4172B		1N4750A	6-24
1N4173		1N4751A	6-24
1N4173A		1N4751A	6-24
1N4173B		1N4751A	6-24
1N4174		1N4752A	6-24
1N4174A		1N4752A	6-24
1N4174B		1N4752A	6-24
1N4175		1N4753A	6-24
1N4175A		1N4753A	6-24
1N4175B		1N4753A	6-24

CF = consult factory representative

**CROSS-REFERENCE (continued)**

Industry Part Number	Motorola Direct Replacement	Motorola Similar Replacement	Page Number
1N4176		1N4754A	6-24
1N4176A		1N4754A	6-24
1N4176B		1N4754A	6-24
1N4177		1N4755A	6-24
1N4177A		1N4755A	6-24
1N4177B		1N4755A	6-24
1N4178		1N4756A	6-24
1N4178A		1N4756A	6-24
1N4178B		1N4756A	6-24
1N4179		1N4757A	6-24
1N4179A		1N4757A	6-24
1N4179B		1N4757A	6-24
1N4180		1N4758A	6-24
1N4180A		1N4758A	6-24
1N4180B		1N4758A	6-24
1N4181		1N4759A	6-24
1N4181A		1N4759A	6-24
1N4181B		1N4759A	6-24
1N4182		1N4760A	6-24
1N4182A		1N4760A	6-24
1N4182B		1N4760A	6-24
1N4183		1N4761A	6-24
1N4183A		1N4761A	6-24
1N4183B		1N4761A	6-24
1N4184		1N4762A	6-24
1N4184A		1N4762A	6-24
1N4184B		1N4762A	6-24
1N4185		1N4763A	6-24
1N4185A		1N4763A	6-24
1N4185B		1N4763A	6-24
1N4186		1N4764A	6-24
1N4186A		1N4764A	6-24
1N4186B		1N4764A	6-24
1N4187		1M110ZS5	6-36
1N4187A		1M110ZS5	6-36
1N4187B		1M110ZS5	6-36
1N4188		1M120ZS5	6-36
1N4188A		1M120ZS5	6-36
1N4188B		1M120ZS5	6-36
1N4189		1M130ZS5	6-36
1N4189A		1M130ZS5	6-36
1N4189B		1M130ZS5	6-36
1N4190		1M150ZS5	6-36
1N4190A		1M150ZS5	6-36
1N4190B		1M150ZS5	6-36
1N4191		1M160ZS5	6-36
1N4191A		1M160ZS5	6-36
1N4191B		1M160ZS5	6-36
1N4192		1M180ZS5	6-36
1N4192A		1M180ZS5	6-36

Industry Part Number	Motorola Direct Replacement	Motorola Similar Replacement	Page Number
1N4192B		1M180ZS5	6-36
1N4193		1M200ZS5	6-36
1N4193A		1M200ZS5	6-36
1N4193B		1M200ZS5	6-36
1N4321		3EZ51D5	6-33
1N4323		1N4736A	6-24
1N4323A		1N4736A	6-24
1N4323B		1N4736A	6-24
1N4324		1N4737A	6-24
1N4324A		1N4737A	6-24
1N4324B		1N4737A	6-24
1N4325		1N4738A	6-24
1N4325A		1N4738A	6-24
1N4325B		1N4738A	6-24
1N4326		1N4739A	6-24
1N4326A		1N4739A	6-24
1N4326B		1N4739A	6-24
1N4327		1N4740A	6-24
1N4327A		1N4740A	6-24
1N4327B		1N4740A	6-24
1N4328		1N4741A	6-24
1N4328A		1N4741A	6-24
1N4328B		1N4741A	6-24
1N4329		1N4742A	6-24
1N4329A		1N4742A	6-24
1N4329B		1N4742A	6-24
1N4330		1N4743A	6-24
1N4330A		1N4743A	6-24
1N4330B		1N4743A	6-24
1N4331		1N4744A	6-24
1N4331A		1N4744A	6-24
1N4331B		1N4744A	6-24
1N4332		1N4745A	6-24
1N4332A		1N4745A	6-24
1N4332B		1N4745A	6-24
1N4333		1N4746A	6-24
1N4333A		1N4746A	6-24
1N4333B		1N4746A	6-24
1N4334		1N4747A	6-24
1N4334A		1N4747A	6-24
1N4334B		1N4747A	6-24
1N4335		1N4748A	6-24
1N4335A		1N4748A	6-24
1N4335B		1N4748A	6-24
1N4336		1N4749A	6-24
1N4336A		1N4749A	6-24
1N4336B		1N4749A	6-24
1N4337		1N4750A	6-24
1N4337A		1N4750A	6-24
1N4337B		1N4750A	6-24

CF = consult factory representative

**CROSS-REFERENCE (continued)**

Industry Part Number	Motorola Direct Replacement	Motorola Similar Replacement	Page Number
1N4338		1N4751A	6-24
1N4338A		1N4751A	6-24
1N4338B		1N4751A	6-24
1N4339		1N4752A	6-24
1N4339A		1N4752A	6-24
1N4339B		1N4752A	6-24
1N4340		1N4753A	6-24
1N4340A		1N4753A	6-24
1N4340B		1N4753A	6-24
1N4341		1N4754A	6-24
1N4341A		1N4754A	6-24
1N4341B		1N4754A	6-24
1N4342		1N4755A	6-24
1N4342A		1N4755A	6-24
1N4342B		1N4755A	6-24
1N4343		1N4756A	6-24
1N4343A		1N4756A	6-24
1N4343B		1N4756A	6-24
1N4344		1N4757A	6-24
1N4344A		1N4757A	6-24
1N4344B		1N4757A	6-24
1N4345		1N4758A	6-24
1N4345A		1N4758A	6-24
1N4345B		1N4758A	6-24
1N4346		1N4759A	6-24
1N4346A		1N4759A	6-24
1N4346B		1N4759A	6-24
1N4347		1N4760A	6-24
1N4347A		1N4760A	6-24
1N4347B		1N4760A	6-24
1N4348		1N4761A	6-24
1N4348A		1N4761A	6-24
1N4348B		1N4761A	6-24
1N4349		1N4762A	6-24
1N4349A		1N4762A	6-24
1N4349B		1N4762A	6-24
1N4350		1N4763A	6-24
1N4350A		1N4763A	6-24
1N4350B		1N4763A	6-24
1N4351		1N4764A	6-24
1N4351A		1N4764A	6-24
1N4351B		1N4764A	6-24
1N4352		1M110ZS5	6-36
1N4352A		1M110ZS5	6-36
1N4352B		1M110ZS5	6-36
1N4353		1M120ZS5	6-36
1N4353A		1M120ZS5	6-36
1N4353B		1M120ZS5	6-36
1N4354		1M130ZS5	6-36
1N4354A		1M130ZS5	6-36

Industry Part Number	Motorola Direct Replacement	Motorola Similar Replacement	Page Number
1N4354B		1M130ZS5	6-36
1N4355		1M150ZS5	6-36
1N4355A		1M150ZS5	6-36
1N4355B		1M150ZS5	6-36
1N4356		1M160ZS5	6-36
1N4356A		1M160ZS5	6-36
1N4356B		1M160ZS5	6-36
1N4357		1M180ZS5	6-36
1N4357A		1M180ZS5	6-36
1N4357B		1M180ZS5	6-36
1N4358		1M200ZS5	6-36
1N4358A		1M200ZS5	6-36
1N4358B		1M200ZS5	6-36
1N4360		1N5221B	6-11
1N4370	1N4370A		6-8
1N4370A	1N4370A		6-8
1N4371	1N4371A		6-8
1N4371A	1N4371A		6-8
1N4372	1N4372A		6-8
1N4372A	1N4372A		6-8
1N4400		1N4736A	6-24
1N4401		1N4737A	6-24
1N4402		1N4738A	6-24
1N4403		1N4739A	6-24
1N4404		1N4740A	6-24
1N4405		1N4741A	6-24
1N4406		1N4742A	6-24
1N4407		1N4743A	6-24
1N4408		1N4744A	6-24
1N4409		1N4745A	6-24
1N4410		1N4746A	6-24
1N4411		1N4747A	6-24
1N4412		1N4748A	6-24
1N4413		1N4749A	6-24
1N4414		1N4750A	6-24
1N4415		1N4751A	6-24
1N4416		1N4752A	6-24
1N4417		1N4753A	6-24
1N4418		1N4754A	6-24
1N4419		1N4755A	6-24
1N4420		1N4756A	6-24
1N4421		1N4757A	6-24
1N4422		1N4758A	6-24
1N4423		1N4759A	6-24
1N4424		1N4760A	6-24
1N4425		1N4761A	6-24
1N4426		1N4762A	6-24
1N4427		1N4763A	6-24
1N4428		1N4764A	6-24
1N4429		1M110ZS5	6-36

CF = consult factory representative

**CROSS-REFERENCE (continued)**

Industry Part Number	Motorola Direct Replacement	Motorola Similar Replacement	Page Number
1N4430		1M120ZS5	6-36
1N4431		1M130ZS5	6-36
1N4432		1M150ZS5	6-36
1N4433		1M160ZS5	6-36
1N4434		1M180ZS5	6-36
1N4435		1M200ZS5	6-36
1N4460		1N4735A	6-24
1N4461		1N4736A	6-24
1N4462		1N4737A	6-24
1N4463		1N4738A	6-24
1N4464		1N4739A	6-24
1N4465		1N4740A	6-24
1N4466		1N4741A	6-24
1N4467		1N4742A	6-24
1N4468		1N4743A	6-24
1N4469		1N4744A	6-24
1N4470		1N4745A	6-24
1N4471		1N4746A	6-24
1N4472		1N4747A	6-24
1N4473		1N4748A	6-24
1N4474		1N4749A	6-24
1N4475		1N4750A	6-24
1N4476		1N4751A	6-24
1N4477		1N4752A	6-24
1N4478		1N4753A	6-24
1N4479		1N4754A	6-24
1N4480		1N4755A	6-24
1N4481		1N4756A	6-24
1N4482		1N4757A	6-24
1N4483		1N4758A	6-24
1N4484		1N4759A	6-24
1N4485		1N4760A	6-24
1N4486		1N4761A	6-24
1N4487		1N4762A	6-24
1N4488		1N4763A	6-24
1N4489		1N4764A	6-24
1N4490		1M110ZS5	6-36
1N4491		1M120ZS5	6-36
1N4492		1M130ZS5	6-36
1N4493		1M150ZS5	6-36
1N4494		1M160ZS5	6-36
1N4495		1M180ZS5	6-36
1N4496		1M200ZS5	6-36
1N4499		1N4735A	6-24
1N4503		3EZ33D5	6-33
1N4504		3EZ200D5	6-34
1N4614		MZ4614	6-17
1N4615		MZ4615	6-17
1N4616		MZ4616	6-17
1N4617		MZ4617	6-17

Industry Part Number	Motorola Direct Replacement	Motorola Similar Replacement	Page Number
1N4618		MZ4618	6-17
1N4619		MZ4619	6-17
1N4620		MZ4620	6-17
1N4621		MZ4621	6-17
1N4622		MZ4622	6-17
1N4623		MZ4623	6-17
1N4624		MZ4624	6-17
1N4625		MZ4625	6-17
1N4626		MZ4626	6-17
1N4627		MZ4627	6-17
1N4628		1N4736A	6-24
1N4629		1N4737A	6-24
1N4630		1N4738A	6-24
1N4631		1N4739A	6-24
1N4632		1N4740A	6-24
1N4633		1N4741A	6-24
1N4634		1N4742A	6-24
1N4635		1N4743A	6-24
1N4636		1N4744A	6-24
1N4637		1N4745A	6-24
1N4638		1N4746A	6-24
1N4639		1N4747A	6-24
1N4640		1N4748A	6-24
1N4641		1N4749A	6-24
1N4642		1N4750A	6-24
1N4643		1N4751A	6-24
1N4644		1N4752A	6-24
1N4645		1N4753A	6-24
1N4646		1N4754A	6-24
1N4647		1N4755A	6-24
1N4648		1N4756A	6-24
1N4649		1N4728A	6-24
1N465		1N5223B	6-11
1N4650		1N4729A	6-24
1N4651		1N4730A	6-24
1N4652		1N4731A	6-24
1N4653		1N4732A	6-24
1N4654		1N4733A	6-24
1N4655		1N4734A	6-24
1N4656		1N4735A	6-24
1N4657		1N4736A	6-24
1N4658		1N4737A	6-24
1N4659		1N4738A	6-24
1N465A		1N5223B	6-11
1N466		1N5226B	6-11
1N4660		1N4739A	6-24
1N4661		1N4740A	6-24
1N4662		1N4741A	6-24
1N4663		1N4742A	6-24
1N4664		1N4743A	6-24

CF = consult factory representative

**CROSS-REFERENCE (continued)**

Industry Part Number	Motorola Direct Replacement	Motorola Similar Replacement	Page Number
1N4665		1N4744A	6-24
1N4666		1N4745A	6-24
1N4667		1N4746A	6-24
1N4668		1N4747A	6-24
1N4669		1N4748A	6-24
1N466A		1N5226B	6-11
1N467		1N5228B	6-11
1N4670		1N4749A	6-24
1N4671		1N4750A	6-24
1N4672		1N4751A	6-24
1N4673		1N4752A	6-24
1N4674		1N4753A	6-24
1N4675		1N4754A	6-24
1N4676		1N4755A	6-24
1N4677		1N4756A	6-24
1N4678	1N4678		6-10
1N4678C	1N4678C		6-10
1N4678D	1N4678D		6-10
1N4679	1N4679		6-10
1N4679C	1N4679C		6-10
1N4679D	1N4679D		6-10
1N467A		1N5228B	6-11
1N468		1N5230B	6-11
1N4680	1N4680		6-10
1N4680C	1N4680C		6-10
1N4680D	1N4680D		6-10
1N4681	1N4681		6-10
1N4681C	1N4681C		6-10
1N4681D	1N4681D		6-10
1N4682	1N4682		6-10
1N4682C	1N4682C		6-10
1N4682D	1N4682D		6-10
1N4683	1N4683		6-10
1N4683C	1N4683C		6-10
1N4683D	1N4683D		6-10
1N4684	1N4684		6-10
1N4684C	1N4684C		6-10
1N4684D	1N4684D		6-10
1N4685	1N4685		6-10
1N4685C	1N4685C		6-10
1N4685D	1N4685D		6-10
1N4686	1N4686		6-10
1N4686C	1N4686C		6-10
1N4686D	1N4686D		6-10
1N4687	1N4687		6-10
1N4687C	1N4687C		6-10
1N4687D	1N4687D		6-10
1N4688	1N4688		6-10
1N4688C	1N4688C		6-10
1N4688D	1N4688D		6-10

Industry Part Number	Motorola Direct Replacement	Motorola Similar Replacement	Page Number
1N4689	1N4689		6-10
1N4689C	1N4689C		6-10
1N4689D	1N4689D		6-10
1N468A		1N5230B	6-11
1N469		1N5232B	6-11
1N4690	1N4690		6-10
1N4690C	1N4690C		6-10
1N4690D	1N4690D		6-10
1N4691	1N4691		6-10
1N4691C	1N4691C		6-10
1N4691D	1N4691D		6-10
1N4692	1N4692		6-10
1N4692C	1N4692C		6-10
1N4692D	1N4692D		6-10
1N4693	1N4693		6-10
1N4693C	1N4693C		6-10
1N4693D	1N4693D		6-10
1N4694	1N4694		6-10
1N4694C	1N4694C		6-10
1N4694D	1N4694D		6-10
1N4695	1N4695		6-10
1N4695C	1N4695C		6-10
1N4695D	1N4695D		6-10
1N4696	1N4696		6-10
1N4696C	1N4696C		6-10
1N4696D	1N4696D		6-10
1N4697	1N4697		6-10
1N4697C	1N4697C		6-10
1N4697D	1N4697D		6-10
1N4698	1N4698		6-10
1N4698C	1N4698C		6-10
1N4698D	1N4698D		6-10
1N4699	1N4699		6-10
1N4699C	1N4699C		6-10
1N4699D	1N4699D		6-10
1N469A		1N5232B	6-11
1N470		1N5235B	6-11
1N4700	1N4700		6-10
1N4700C	1N4700C		6-10
1N4700D	1N4700D		6-10
1N4701	1N4701		6-10
1N4701C	1N4701C		6-10
1N4701D	1N4701D		6-10
1N4702	1N4702		6-10
1N4702C	1N4702C		6-10
1N4702D	1N4702D		6-10
1N4703	1N4703		6-10
1N4703C	1N4703C		6-10
1N4703D	1N4703D		6-10
1N4704	1N4704		6-10

CF = consult factory representative



**CROSS-REFERENCE (continued)**

Industry Part Number	Motorola Direct Replacement	Motorola Similar Replacement	Page Number
1N4704C	1N4704C		6-10
1N4704D	1N4704D		6-10
1N4705	1N4705		6-10
1N4705C	1N4705C		6-10
1N4705D	1N4705D		6-10
1N4706	1N4706		6-10
1N4706C	1N4706C		6-10
1N4706D	1N4706D		6-10
1N4707	1N4707		6-10
1N4707C	1N4707C		6-10
1N4707D	1N4707D		6-10
1N4708	1N4708		6-10
1N4708C	1N4708C		6-10
1N4708D	1N4708D		6-10
1N4709	1N4709		6-10
1N4709C	1N4709C		6-10
1N4709D	1N4709D		6-10
1N470A		1N5235B	6-11
1N4710	1N4710		6-10
1N4710C	1N4710C		6-10
1N4710D	1N4710D		6-10
1N4711	1N4711		6-10
1N4711C	1N4711C		6-10
1N4711D	1N4711D		6-10
1N4712	1N4712		6-10
1N4712C	1N4712C		6-10
1N4712D	1N4712D		6-10
1N4713	1N4713		6-10
1N4713C	1N4713C		6-10
1N4713D	1N4713D		6-10
1N4714	1N4714		6-10
1N4714C	1N4714C		6-10
1N4714D	1N4714D		6-10
1N4715	1N4715		6-10
1N4715C	1N4715C		6-10
1N4715D	1N4715D		6-10
1N4716	1N4716		6-10
1N4716C	1N4716C		6-10
1N4716D	1N4716D		6-10
1N4717	1N4717		6-10
1N4717C	1N4717C		6-10
1N4717D	1N4717D		6-10
1N4728	1N4728A		6-24
1N4728A	1N4728A		6-24
1N4728C	1N4728C		6-24
1N4728D	1N4728D		6-24
1N4729	1N4729A		6-24
1N4729A	1N4729A		6-24
1N4729C	1N4729C		6-24
1N4729D	1N4729D		6-24

Industry Part Number	Motorola Direct Replacement	Motorola Similar Replacement	Page Number
1N4730	1N4730A		6-24
1N4730A	1N4730A		6-24
1N4730C	1N4730C		6-24
1N4730D	1N4730D		6-24
1N4731	1N4731A		6-24
1N4731A	1N4731A		6-24
1N4731C	1N4731C		6-24
1N4731D	1N4731D		6-24
1N4732	1N4732A		6-24
1N4732A	1N4732A		6-24
1N4732C	1N4732C		6-24
1N4732D	1N4732D		6-24
1N4733	1N4733A		6-24
1N4733A	1N4733A		6-24
1N4733C	1N4733C		6-24
1N4733D	1N4733D		6-24
1N4734	1N4734A		6-24
1N4734A	1N4734A		6-24
1N4734C	1N4734C		6-24
1N4734D	1N4734D		6-24
1N4735	1N4735A		6-24
1N4735A	1N4735A		6-24
1N4735C	1N4735C		6-24
1N4735D	1N4735D		6-24
1N4736	1N4736A		6-24
1N4736A	1N4736A		6-24
1N4736C	1N4736C		6-24
1N4736D	1N4736D		6-24
1N4737	1N4737A		6-24
1N4737A	1N4737A		6-24
1N4737C	1N4737C		6-24
1N4737D	1N4737D		6-24
1N4738	1N4738A		6-24
1N4738A	1N4738A		6-24
1N4738C	1N4738C		6-24
1N4738D	1N4738D		6-24
1N4739	1N4739A		6-24
1N4739A	1N4739A		6-24
1N4739C	1N4739C		6-24
1N4739D	1N4739D		6-24
1N4740	1N4740A		6-24
1N4740A	1N4740A		6-24
1N4740C	1N4740C		6-24
1N4740D	1N4740D		6-24
1N4741	1N4741A		6-24
1N4741A	1N4741A		6-24
1N4741C	1N4741C		6-24
1N4741D	1N4741D		6-24
1N4742	1N4742A		6-24
1N4742A	1N4742A		6-24

CF = consult factory representative

**CROSS-REFERENCE (continued)**

Industry Part Number	Motorola Direct Replacement	Motorola Similar Replacement	Page Number
1N4742C	1N4742C		6-24
1N4742D	1N4742D		6-24
1N4743	1N4743A		6-24
1N4743A	1N4743A		6-24
1N4743C	1N4743C		6-24
1N4743D	1N4743D		6-24
1N4744	1N4744A		6-24
1N4744A	1N4744A		6-24
1N4744C	1N4744C		6-24
1N4744D	1N4744D		6-24
1N4745	1N4745A		6-24
1N4745A	1N4745A		6-24
1N4745C	1N4745C		6-24
1N4745D	1N4745D		6-24
1N4746	1N4746A		6-24
1N4746A	1N4746A		6-24
1N4746C	1N4746C		6-24
1N4746D	1N4746D		6-24
1N4747	1N4747A		6-24
1N4747A	1N4747A		6-24
1N4747C	1N4747C		6-24
1N4747D	1N4747D		6-24
1N4748	1N4748A		6-24
1N4748A	1N4748A		6-24
1N4748C	1N4748C		6-24
1N4748D	1N4748D		6-24
1N4749	1N4749A		6-24
1N4749A	1N4749A		6-24
1N4749C	1N4749C		6-24
1N4749D	1N4749D		6-24
1N4750	1N4750A		6-24
1N4750A	1N4750A		6-24
1N4750C	1N4750C		6-24
1N4750D	1N4750D		6-24
1N4751	1N4751A		6-24
1N4751A	1N4751A		6-24
1N4751C	1N4751C		6-24
1N4751D	1N4751D		6-24
1N4752	1N4752A		6-24
1N4752A	1N4752A		6-24
1N4752C	1N4752C		6-24
1N4752D	1N4752D		6-24
1N4753	1N4753A		6-24
1N4753A	1N4753A		6-24
1N4753C	1N4753C		6-24
1N4753D	1N4753D		6-24
1N4754	1N4754A		6-24
1N4754A	1N4754A		6-24
1N4754C	1N4754C		6-24
1N4754D	1N4754D		6-24

Industry Part Number	Motorola Direct Replacement	Motorola Similar Replacement	Page Number
1N4755	1N4755A		6-24
1N4755A	1N4755A		6-24
1N4755C	1N4755C		6-24
1N4755D	1N4755D		6-24
1N4756	1N4756A		6-24
1N4756A	1N4756A		6-24
1N4756C	1N4756C		6-24
1N4756D	1N4756D		6-24
1N4757	1N4757A		6-24
1N4757A	1N4757A		6-24
1N4757C	1N4757C		6-24
1N4757D	1N4757D		6-24
1N4758	1N4758A		6-24
1N4758A	1N4758A		6-24
1N4758C	1N4758C		6-24
1N4758D	1N4758D		6-24
1N4759	1N4759A		6-24
1N4759A	1N4759A		6-24
1N4759C	1N4759C		6-24
1N4759D	1N4759D		6-24
1N4760	1N4760A		6-24
1N4760A	1N4760A		6-24
1N4760C	1N4760C		6-24
1N4760D	1N4760D		6-24
1N4761	1N4761A		6-24
1N4761A	1N4761A		6-24
1N4761C	1N4761C		6-24
1N4761D	1N4761D		6-24
1N4762	1N4762A		6-24
1N4762A	1N4762A		6-24
1N4762C	1N4762C		6-24
1N4762D	1N4762D		6-24
1N4763	1N4763A		6-24
1N4763A	1N4763A		6-24
1N4763C	1N4763C		6-24
1N4763D	1N4763D		6-24
1N4764	1N4764A		6-24
1N4764A	1N4764A		6-24
1N4764C	1N4764C		6-24
1N4764D	1N4764D		6-24
1N4831		1N4739A	6-24
1N4831A		1N4739A	6-24
1N4831B		1N4739A	6-24
1N4832		1N4740A	6-24
1N4832A		1N4740A	6-24
1N4832B		1N4740A	6-24
1N4833		1N4741A	6-24
1N4833A		1N4741A	6-24
1N4833B		1N4741A	6-24
1N4834		1N4742A	6-24

CF = consult factory representative

**CROSS-REFERENCE (continued)**

Industry Part Number	Motorola Direct Replacement	Motorola Similar Replacement	Page Number
1N4834A		1N4742A	6-24
1N4834B		1N4742A	6-24
1N4835		1N4743A	6-24
1N4835A		1N4743A	6-24
1N4835B		1N4743A	6-24
1N4836		1N4744A	6-24
1N4836A		1N4744A	6-24
1N4836B		1N4744A	6-24
1N4837		1N4745A	6-24
1N4837A		1N4745A	6-24
1N4837B		1N4745A	6-24
1N4838		1N4746A	6-24
1N4838A		1N4746A	6-24
1N4838B		1N4746A	6-24
1N4839		1N4747A	6-24
1N4839A		1N4747A	6-24
1N4839B		1N4747A	6-24
1N4840		1N4748A	6-24
1N4840A		1N4748A	6-24
1N4840B		1N4748A	6-24
1N4841		1N4749A	6-24
1N4841A		1N4749A	6-24
1N4841B		1N4749A	6-24
1N4842		1N4750A	6-24
1N4842A		1N4750A	6-24
1N4842B		1N4750A	6-24
1N4843		1N4751A	6-24
1N4843A		1N4751A	6-24
1N4843B		1N4751A	6-24
1N4844		1N4752A	6-24
1N4844A		1N4752A	6-24
1N4844B		1N4752A	6-24
1N4845		1N4753A	6-24
1N4845A		1N4753A	6-24
1N4845B		1N4753A	6-24
1N4846		1N4754A	6-24
1N4846A		1N4754A	6-24
1N4846B		1N4754A	6-24
1N4847		1N4755A	6-24
1N4847A		1N4755A	6-24
1N4847B		1N4755A	6-24
1N4848		1N4756A	6-24
1N4848A		1N4756A	6-24
1N4848B		1N4756A	6-24
1N4849		1N4757A	6-24
1N4849A		1N4757A	6-24
1N4849B		1N4757A	6-24
1N4850		1N4758A	6-24
1N4850A		1N4758A	6-24
1N4850B		1N4758A	6-24

Industry Part Number	Motorola Direct Replacement	Motorola Similar Replacement	Page Number
1N4851		1N4759A	6-24
1N4851A		1N4759A	6-24
1N4851B		1N4759A	6-24
1N4852		1N4760A	6-24
1N4852A		1N4760A	6-24
1N4852B		1N4760A	6-24
1N4853		1N4761A	6-24
1N4853A		1N4761A	6-24
1N4853B		1N4761A	6-24
1N4854		1N4762A	6-24
1N4854A		1N4762A	6-24
1N4854B		1N4762A	6-24
1N4855		1N4763A	6-24
1N4855A		1N4763A	6-24
1N4855B		1N4763A	6-24
1N4856		1N4764A	6-24
1N4856A		1N4764A	6-24
1N4856B		1N4764A	6-24
1N4857		1M110ZS5	6-36
1N4857A		1M110ZS5	6-36
1N4857B		1M110ZS5	6-36
1N4858		1M120ZS5	6-36
1N4858A		1M120ZS5	6-36
1N4858B		1M120ZS5	6-36
1N4859		1M130ZS5	6-36
1N4859A		1M130ZS5	6-36
1N4859B		1M130ZS5	6-36
1N4860		1M150ZS5	6-36
1N4860A		1M150ZS5	6-36
1N4860B		1M150ZS5	6-36
1N4881		3EZ39D5	6-33
1N4882		3EZ20D5	6-33
1N4883		3EZ62D5	6-33
1N4884		3EZ39D5	6-33
1N4889		1N5372B	6-39
1N4954		1N5342B	6-39
1N4955		1N5343B	6-39
1N4956		1N5344B	6-39
1N4957		1N5346B	6-39
1N4958		1N5347B	6-39
1N4959		1N5348B	6-39
1N4960		1N5349B	6-39
1N4961		1N5350B	6-39
1N4962		1N5352B	6-39
1N4963		1N5353B	6-39
1N4964		1N5355B	6-39
1N4965		1N5357B	6-39
1N4966		1N5358B	6-39
1N4967		1N5359B	6-39
1N4968		1N5361B	6-39

CF = consult factory representative

**CROSS-REFERENCE (continued)**

Industry Part Number	Motorola Direct Replacement	Motorola Similar Replacement	Page Number
1N4969		1N5363B	6-39
1N4970		1N5364B	6-39
1N4971		1N5365B	6-39
1N4972		1N5366B	6-39
1N4973		1N5367B	6-39
1N4974		1N5368B	6-39
1N4975		1N5369B	6-39
1N4976		1N5370B	6-39
1N4977		1N5372B	6-39
1N4978		1N5373B	6-39
1N4979		1N5374B	6-39
1N4980		1N5375B	6-39
1N4981		1N5377B	6-39
1N4982		1N5378B	6-39
1N4983		1N5379B	6-39
1N4984		1N5380B	6-39
1N4985		1N5381B	6-39
1N4986		1N5383B	6-40
1N4987		1N5384B	6-40
1N4988		1N5386B	6-40
1N4989		1N5388B	6-40
1N5008		1N5333B	6-39
1N5008A		1N5333B	6-39
1N5009		1N5334B	6-39
1N5009A		1N5334B	6-39
1N5010		3EZ3.9D5	6-33
1N5010A		3EZ3.9D5	6-33
1N5011		3EZ4.3D5	6-33
1N5011A		3EZ4.3D5	6-33
1N5012		3EZ4.7D5	6-33
1N5012A		3EZ4.7D5	6-33
1N5013		3EZ5.1D5	6-33
1N5013A		3EZ5.1D5	6-33
1N5014		3EZ5.6D5	6-33
1N5014A		3EZ5.6D5	6-33
1N5015		3EZ6.2D5	6-33
1N5015A		3EZ6.2D5	6-33
1N5016		3EZ6.8D5	6-33
1N5016A		3EZ6.8D5	6-33
1N5017		3EZ7.5D5	6-33
1N5017A		3EZ7.5D5	6-33
1N5018		3EZ8.2D5	6-33
1N5018A		3EZ8.2D5	6-33
1N5019		3EZ9.1D5	6-33
1N5019A		3EZ9.1D5	6-33
1N5020		3EZ10D5	6-33
1N5020A		3EZ10D5	6-33
1N5021		3EZ11D5	6-33
1N5021A		3EZ11D5	6-33
1N5022		3EZ12D5	6-33

Industry Part Number	Motorola Direct Replacement	Motorola Similar Replacement	Page Number
1N5022A		3EZ12D5	6-33
1N5023		3EZ13D5	6-33
1N5023A		3EZ13D5	6-33
1N5024		3EZ14D5	6-33
1N5024A		3EZ14D5	6-33
1N5025		3EZ15D5	6-33
1N5025A		3EZ15D5	6-33
1N5026		3EZ16D5	6-33
1N5026A		3EZ16D5	6-33
1N5027		3EZ17D5	6-33
1N5027A		3EZ17D5	6-33
1N5028		3EZ18D5	6-33
1N5028A		3EZ18D5	6-33
1N5029		3EZ19D5	6-33
1N5029A		3EZ19D5	6-33
1N5030		3EZ20D5	6-33
1N5030A		3EZ20D5	6-33
1N5031		3EZ22D5	6-33
1N5031A		3EZ22D5	6-33
1N5032		3EZ24D5	6-33
1N5032A		3EZ24D5	6-33
1N5033		3EZ24D5	6-33
1N5033A		3EZ24D5	6-33
1N5034		3EZ27D5	6-33
1N5034A		3EZ27D5	6-33
1N5035		3EZ30D5	6-33
1N5035A		3EZ30D5	6-33
1N5036		3EZ33D5	6-33
1N5036A		3EZ33D5	6-33
1N5037		3EZ36D5	6-33
1N5037A		3EZ36D5	6-33
1N5038		3EZ39D5	6-33
1N5038A		3EZ39D5	6-33
1N5039		3EZ43D5	6-33
1N5039A		3EZ43D5	6-33
1N5040		3EZ47D5	6-33
1N5040A		3EZ47D5	6-33
1N5041		3EZ47D5	6-33
1N5041A		3EZ47D5	6-33
1N5042		3EZ51D5	6-33
1N5042A		3EZ51D5	6-33
1N5043		3EZ51D5	6-33
1N5043A		3EZ51D5	6-33
1N5044		3EZ51D5	6-33
1N5044A		3EZ51D5	6-33
1N5045		3EZ56D5	6-33
1N5045A		3EZ56D5	6-33
1N5046		3EZ62D5	6-33
1N5046A		3EZ62D5	6-33
1N5047		3EZ68D5	6-33

CF = consult factory representative

**CROSS-REFERENCE (continued)**

Industry Part Number	Motorola Direct Replacement	Motorola Similar Replacement	Page Number
1N5047A		3EZ68D5	6-33
1N5048		3EZ75D5	6-33
1N5048A		3EZ75D5	6-33
1N5049		3EZ82D5	6-33
1N5049A		3EZ82D5	6-33
1N5050		3EZ91D5	6-33
1N5050A		3EZ91D5	6-33
1N5051		3EZ100D5	6-33
1N5051A		3EZ100D5	6-33
1N5063		3EZ6.8D5	6-33
1N5064		3EZ7.5D5	6-33
1N5065		3EZ8.2D5	6-33
1N5066		3EZ9.1D5	6-33
1N5067		3EZ10D5	6-33
1N5068		3EZ11D5	6-33
1N5069		3EZ13D5	6-33
1N5070		3EZ14D5	6-33
1N5071		3EZ15D5	6-33
1N5072		3EZ16D5	6-33
1N5073		3EZ18D5	6-33
1N5074		3EZ22D5	6-33
1N5075		3EZ24D5	6-33
1N5076		3EZ27D5	6-33
1N5077		3EZ30D5	6-33
1N5078		3EZ33D5	6-33
1N5079		3EZ36D5	6-33
1N5080		3EZ39D5	6-33
1N5081		3EZ39D5	6-33
1N5082		3EZ43D5	6-33
1N5083		3EZ47D5	6-33
1N5084		3EZ47D5	6-33
1N5085		3EZ51D5	6-33
1N5086		3EZ51D5	6-33
1N5087		3EZ56D5	6-33
1N5088		3EZ62D5	6-33
1N5089		3EZ62D5	6-33
1N5090		3EZ68D5	6-33
1N5091		3EZ68D5	6-33
1N5092		3EZ75D5	6-33
1N5093		3EZ82D5	6-33
1N5094		3EZ82D5	6-33
1N5095		3EZ91D5	6-33
1N5096		3EZ110D5	6-33
1N5097		3EZ120D5	6-33
1N5098		3EZ130D5	6-33
1N5099		3EZ140D5	6-33
1N5100		3EZ160D5	6-33
1N5101		3EZ170D5	6-33
1N5102		3EZ180D5	6-33
1N5103		3EZ190D5	6-33

Industry Part Number	Motorola Direct Replacement	Motorola Similar Replacement	Page Number
1N5104		3EZ200D5	6-34
1N5105		3EZ220D5	6-34
1N5106		3EZ240D5	6-34
1N5107		3EZ270D5	6-34
1N5108		3EZ270D5	6-34
1N5109		3EZ270D5	6-34
1N5110		3EZ300D5	6-34
1N5111		3EZ330D5	6-34
1N5112		3EZ330D5	6-34
1N5113		3EZ330D5	6-34
1N5114		3EZ360D5	6-34
1N5115		3EZ400D5	6-34
1N5116		3EZ400D5	6-34
1N5117		3EZ400D5	6-34
1N5118		1N5351B	6-39
1N5119		1N5366B	6-39
1N5120		1N5368B	6-39
1N5121		1N5369B	6-39
1N5122		1N5371B	6-39
1N5123		1N5373B	6-39
1N5124		1N5375B	6-39
1N5125		1N5377B	6-39
1N5126		1N5382B	6-39
1N5127		1N5385B	6-40
1N5128		1N5387B	6-40
1N5221	1N5221B		6-11
1N5221A	1N5221B		6-11
1N5221B	1N5221B		6-11
1N5221C	1N5221C		6-11
1N5221D	1N5221D		6-11
1N5222	1N5222B		6-11
1N5222A	1N5222B		6-11
1N5222B	1N5222B		6-11
1N5222C	1N5222C		6-11
1N5222D	1N5222D		6-11
1N5223	1N5223B		6-11
1N5223A	1N5223B		6-11
1N5223B	1N5223B		6-11
1N5223C	1N5223C		6-11
1N5223D	1N5223D		6-11
1N5224	1N5224B		6-11
1N5224A	1N5224B		6-11
1N5224B	1N5224B		6-11
1N5224C	1N5224C		6-11
1N5224D	1N5224D		6-11
1N5225	1N5225B		6-11
1N5225A	1N5225B		6-11
1N5225B	1N5225B		6-11
1N5225C	1N5225C		6-11
1N5225D	1N5225D		6-11

CF = consult factory representative

**CROSS-REFERENCE (continued)**

Industry Part Number	Motorola Direct Replacement	Motorola Similar Replacement	Page Number
1N5226	1N5226B		6-11
1N5226A	1N5226B		6-11
1N5226B	1N5226B		6-11
1N5226C	1N5226C		6-11
1N5226D	1N5226D		6-11
1N5227	1N5227B		6-11
1N5227A	1N5227B		6-11
1N5227B	1N5227B		6-11
1N5227C	1N5227C		6-11
1N5227D	1N5227D		6-11
1N5228	1N5228B		6-11
1N5228A	1N5228B		6-11
1N5228B	1N5228B		6-11
1N5228C	1N5228C		6-11
1N5228D	1N5228D		6-11
1N5229	1N5229B		6-11
1N5229A	1N5229B		6-11
1N5229B	1N5229B		6-11
1N5229C	1N5229C		6-11
1N5229D	1N5229D		6-11
1N5230	1N5230B		6-11
1N5230A	1N5230B		6-11
1N5230B	1N5230B		6-11
1N5230C	1N5230C		6-11
1N5230D	1N5230D		6-11
1N5231	1N5231B		6-11
1N5231A	1N5231B		6-11
1N5231B	1N5231B		6-11
1N5231C	1N5231C		6-11
1N5231D	1N5231D		6-11
1N5232	1N5232B		6-11
1N5232A	1N5232B		6-11
1N5232B	1N5232B		6-11
1N5232C	1N5232C		6-11
1N5232D	1N5232D		6-11
1N5233	1N5233B		6-11
1N5233A	1N5233B		6-11
1N5233B	1N5233B		6-11
1N5233C	1N5233C		6-11
1N5233D	1N5233D		6-11
1N5234	1N5234B		6-11
1N5234A	1N5234B		6-11
1N5234B	1N5234B		6-11
1N5234C	1N5234C		6-11
1N5234D	1N5234D		6-11
1N5235	1N5235B		6-11
1N5235A	1N5235B		6-11
1N5235B	1N5235B		6-11
1N5235C	1N5235C		6-11
1N5235D	1N5235D		6-11

Industry Part Number	Motorola Direct Replacement	Motorola Similar Replacement	Page Number
1N5236	1N5236B		6-11
1N5236A	1N5236B		6-11
1N5236B	1N5236B		6-11
1N5236C	1N5236C		6-11
1N5236D	1N5236D		6-11
1N5237	1N5237B		6-11
1N5237A	1N5237B		6-11
1N5237B	1N5237B		6-11
1N5237C	1N5237C		6-11
1N5237D	1N5237D		6-11
1N5238	1N5238B		6-11
1N5238A	1N5238B		6-11
1N5238B	1N5238B		6-11
1N5238C	1N5238C		6-11
1N5238D	1N5238D		6-11
1N5239	1N5239B		6-11
1N5239A	1N5239B		6-11
1N5239B	1N5239B		6-11
1N5239C	1N5239C		6-11
1N5239D	1N5239D		6-11
1N5240	1N5240B		6-11
1N5240A	1N5240B		6-11
1N5240B	1N5240B		6-11
1N5240C	1N5240C		6-11
1N5240D	1N5240D		6-11
1N5241	1N5241B		6-11
1N5241A	1N5241B		6-11
1N5241B	1N5241B		6-11
1N5241C	1N5241C		6-11
1N5241D	1N5241D		6-11
1N5242	1N5242B		6-11
1N5242A	1N5242B		6-11
1N5242B	1N5242B		6-11
1N5242C	1N5242C		6-11
1N5242D	1N5242D		6-11
1N5243	1N5243B		6-11
1N5243A	1N5243B		6-11
1N5243B	1N5243B		6-11
1N5243C	1N5243C		6-11
1N5243D	1N5243D		6-11
1N5244	1N5244B		6-11
1N5244A	1N5244B		6-11
1N5244B	1N5244B		6-11
1N5244C	1N5244C		6-11
1N5244D	1N5244D		6-11
1N5245	1N5245B		6-11
1N5245A	1N5245B		6-11
1N5245B	1N5245B		6-11
1N5245C	1N5245C		6-11
1N5245D	1N5245D		6-11

CF = consult factory representative

**CROSS-REFERENCE (continued)**

Industry Part Number	Motorola Direct Replacement	Motorola Similar Replacement	Page Number
1N5246	1N5246B		6-11
1N5246A	1N5246B		6-11
1N5246B	1N5246B		6-11
1N5246C	1N5246C		6-11
1N5246D	1N5246D		6-11
1N5247	1N5247B		6-11
1N5247A	1N5247B		6-11
1N5247B	1N5247B		6-11
1N5247C	1N5247C		6-11
1N5247D	1N5247D		6-11
1N5248	1N5248B		6-11
1N5248A	1N5248B		6-11
1N5248B	1N5248B		6-11
1N5248C	1N5248C		6-11
1N5248D	1N5248D		6-11
1N5249	1N5249B		6-11
1N5249A	1N5249B		6-11
1N5249B	1N5249B		6-11
1N5249C	1N5249C		6-11
1N5249D	1N5249D		6-11
1N5250	1N5250B		6-11
1N5250A	1N5250B		6-11
1N5250B	1N5250B		6-11
1N5250C	1N5250C		6-11
1N5250D	1N5250D		6-11
1N5251	1N5251B		6-11
1N5251A	1N5251B		6-11
1N5251B	1N5251B		6-11
1N5251C	1N5251C		6-11
1N5251D	1N5251D		6-11
1N5252	1N5252B		6-11
1N5252A	1N5252B		6-11
1N5252B	1N5252B		6-11
1N5252C	1N5252C		6-11
1N5252D	1N5252D		6-11
1N5253	1N5253B		6-11
1N5253A	1N5253B		6-11
1N5253B	1N5253B		6-11
1N5253C	1N5253C		6-11
1N5253D	1N5253D		6-11
1N5254	1N5254B		6-11
1N5254A	1N5254B		6-11
1N5254B	1N5254B		6-11
1N5254C	1N5254C		6-11
1N5254D	1N5254D		6-11
1N5255	1N5255B		6-11
1N5255A	1N5255B		6-11
1N5255B	1N5255B		6-11
1N5255C	1N5255C		6-11
1N5255D	1N5255D		6-11

Industry Part Number	Motorola Direct Replacement	Motorola Similar Replacement	Page Number
1N5256	1N5256B		6-11
1N5256A	1N5256B		6-11
1N5256B	1N5256B		6-11
1N5256C	1N5256C		6-11
1N5256D	1N5256D		6-11
1N5257	1N5257B		6-11
1N5257A	1N5257B		6-11
1N5257B	1N5257B		6-11
1N5257C	1N5257C		6-11
1N5257D	1N5257D		6-11
1N5258	1N5258B		6-11
1N5258A	1N5258B		6-11
1N5258B	1N5258B		6-11
1N5258C	1N5258C		6-11
1N5258D	1N5258D		6-11
1N5259	1N5259B		6-11
1N5259A	1N5259B		6-11
1N5259B	1N5259B		6-11
1N5259C	1N5259C		6-11
1N5259D	1N5259D		6-11
1N5260	1N5260B		6-11
1N5260A	1N5260B		6-11
1N5260B	1N5260B		6-11
1N5260C	1N5260C		6-11
1N5260D	1N5260D		6-11
1N5261	1N5261B		6-11
1N5261A	1N5261B		6-11
1N5261B	1N5261B		6-11
1N5261C	1N5261C		6-11
1N5261D	1N5261D		6-11
1N5262	1N5262B		6-11
1N5262A	1N5262B		6-11
1N5262B	1N5262B		6-11
1N5262C	1N5262C		6-11
1N5262D	1N5262D		6-11
1N5263	1N5263B		6-11
1N5263A	1N5263B		6-11
1N5263B	1N5263B		6-11
1N5263C	1N5263C		6-11
1N5263D	1N5263D		6-11
1N5264	1N5264B		6-11
1N5264A	1N5264B		6-11
1N5264B	1N5264B		6-11
1N5264C	1N5264C		6-11
1N5264D	1N5264D		6-11
1N5265	1N5265B		6-11
1N5265A	1N5265B		6-11
1N5265B	1N5265B		6-11
1N5265C	1N5265C		6-11
1N5265D	1N5265D		6-11

CF = consult factory representative

**CROSS-REFERENCE (continued)**

Industry Part Number	Motorola Direct Replacement	Motorola Similar Replacement	Page Number
1N5266	1N5266B		6-12
1N5266A	1N5266B		6-12
1N5266B	1N5266B		6-12
1N5266C	1N5266C		6-12
1N5266D	1N5266D		6-12
1N5267	1N5267B		6-12
1N5267A	1N5267B		6-12
1N5267B	1N5267B		6-12
1N5267C	1N5267C		6-12
1N5267D	1N5267D		6-12
1N5268	1N5268B		6-12
1N5268A	1N5268B		6-12
1N5268B	1N5268B		6-12
1N5268C	1N5268C		6-12
1N5268D	1N5268D		6-12
1N5269	1N5269B		6-12
1N5269A	1N5269B		6-12
1N5269B	1N5269B		6-12
1N5269C	1N5269C		6-12
1N5269D	1N5269D		6-12
1N5270	1N5270B		6-12
1N5270A	1N5270B		6-12
1N5270B	1N5270B		6-12
1N5270C	1N5270C		6-12
1N5270D	1N5270D		6-12
1N5271	1N5271B		6-12
1N5271A	1N5271B		6-12
1N5271B	1N5271B		6-12
1N5271C	1N5271C		6-12
1N5271D	1N5271D		6-12
1N5272	1N5272B		6-12
1N5272A	1N5272B		6-12
1N5272B	1N5272B		6-12
1N5272C	1N5272C		6-12
1N5272D	1N5272D		6-12
1N5273	1N5273B		6-12
1N5273A	1N5273B		6-12
1N5273B	1N5273B		6-12
1N5273C	1N5273C		6-12
1N5273D	1N5273D		6-12
1N5274	1N5274B		6-12
1N5274A	1N5274B		6-12
1N5274B	1N5274B		6-12
1N5274C	1N5274C		6-12
1N5274D	1N5274D		6-12
1N5275	1N5275B		6-12
1N5275A	1N5275B		6-12
1N5275B	1N5275B		6-12
1N5275C	1N5275C		6-12
1N5275D	1N5275D		6-12

Industry Part Number	Motorola Direct Replacement	Motorola Similar Replacement	Page Number
1N5276	1N5276B		6-12
1N5276A	1N5276B		6-12
1N5276B	1N5276B		6-12
1N5276C	1N5276C		6-12
1N5276D	1N5276D		6-12
1N5277	1N5277B		6-12
1N5277A	1N5277B		6-12
1N5277B	1N5277B		6-12
1N5277C	1N5277C		6-12
1N5277D	1N5277D		6-12
1N5278	1N5278B		6-12
1N5278A	1N5278B		6-12
1N5278B	1N5278B		6-12
1N5278C	1N5278C		6-12
1N5278D	1N5278D		6-12
1N5279	1N5279B		6-12
1N5279A	1N5279B		6-12
1N5279B	1N5279B		6-12
1N5279C	1N5279C		6-12
1N5279D	1N5279D		6-12
1N5280	1N5280B		6-12
1N5280A	1N5280B		6-12
1N5280B	1N5280B		6-12
1N5280C	1N5280C		6-12
1N5280D	1N5280D		6-12
1N5281	1N5281B		6-12
1N5281A	1N5281B		6-12
1N5281B	1N5281B		6-12
1N5281C	1N5281C		6-12
1N5281D	1N5281D		6-12
1N5283	1N5283		9-3
1N5284	1N5284		9-3
1N5285	1N5285		9-3
1N5286	1N5286		9-3
1N5287	1N5287		9-3
1N5288	1N5288		9-3
1N5289	1N5289		9-3
1N5290	1N5290		9-3
1N5291	1N5291		9-3
1N5292	1N5292		9-3
1N5293	1N5293		9-3
1N5294	1N5294		9-3
1N5295	1N5295		9-3
1N5296	1N5296		9-3
1N5297	1N5297		9-3
1N5298	1N5298		9-3
1N5299	1N5299		9-3
1N5300	1N5300		9-3
1N5301	1N5301		9-3
1N5302	1N5302		9-3

CF = consult factory representative



**CROSS-REFERENCE (continued)**

Industry Part Number	Motorola Direct Replacement	Motorola Similar Replacement	Page Number
1N5303	1N5303		9-3
1N5304	1N5304		9-3
1N5305	1N5305		9-3
1N5306	1N5306		9-3
1N5307	1N5307		9-3
1N5308	1N5308		9-3
1N5309	1N5309		9-3
1N5310	1N5310		9-3
1N5311	1N5311		9-3
1N5312	1N5312		9-3
1N5313	1N5313		9-3
1N5314	1N5314		9-3
1N5333	1N5333B		6-39
1N5333A	1N5333B		6-39
1N5333B	1N5333B		6-39
1N5333C	CF		-
1N5333D	CF		-
1N5334	1N5334B		6-39
1N5334A	1N5334B		6-39
1N5334B	1N5334B		6-39
1N5334C	CF		-
1N5334D	CF		-
1N5335	1N5335B		6-39
1N5335A	1N5335B		6-39
1N5335B	1N5335B		6-39
1N5335C	CF		-
1N5335D	CF		-
1N5336	1N5336B		6-39
1N5336A	1N5336B		6-39
1N5336B	1N5336B		6-39
1N5336C	CF		-
1N5336D	CF		-
1N5337	1N5337B		6-39
1N5337A	1N5337B		6-39
1N5337B	1N5337B		6-39
1N5337C	CF		-
1N5337D	CF		-
1N5338	1N5338B		6-39
1N5338A	1N5338B		6-39
1N5338B	1N5338B		6-39
1N5338C	CF		-
1N5338D	CF		-
1N5339	1N5339B		6-39
1N5339A	1N5339B		6-39
1N5339B	1N5339B		6-39
1N5339C	CF		-
1N5339D	CF		-
1N5340	1N5340B		6-39
1N5340A	1N5340B		6-39
1N5340B	1N5340B		6-39

Industry Part Number	Motorola Direct Replacement	Motorola Similar Replacement	Page Number
1N5340C	CF		-
1N5340D	CF		-
1N5341	1N5341B		6-39
1N5341A	1N5341B		6-39
1N5341B	1N5341B		6-39
1N5341C	CF		-
1N5341D	CF		-
1N5342	1N5342B		6-39
1N5342A	1N5342B		6-39
1N5342B	1N5342B		6-39
1N5342C	CF		-
1N5342D	CF		-
1N5343	1N5343B		6-39
1N5343A	1N5343B		6-39
1N5343B	1N5343B		6-39
1N5343C	CF		-
1N5343D	CF		-
1N5344	1N5344B		6-39
1N5344A	1N5344B		6-39
1N5344B	1N5344B		6-39
1N5344C	CF		-
1N5344D	CF		-
1N5345	1N5345B		6-39
1N5345A	1N5345B		6-39
1N5345B	1N5345B		6-39
1N5345C	CF		-
1N5345D	CF		-
1N5346	1N5346B		6-39
1N5346A	1N5346B		6-39
1N5346B	1N5346B		6-39
1N5346C	CF		-
1N5346D	CF		-
1N5347	1N5347B		6-39
1N5347A	1N5347B		6-39
1N5347B	1N5347B		6-39
1N5347C	CF		-
1N5347D	CF		-
1N5348	1N5348B		6-39
1N5348A	1N5348B		6-39
1N5348B	1N5348B		6-39
1N5348C	CF		-
1N5348D	CF		-
1N5349	1N5349B		6-39
1N5349A	1N5349B		6-39
1N5349B	1N5349B		6-39
1N5349C	CF		-
1N5349D	CF		-
1N5350	1N5350B		6-39
1N5350A	1N5350B		6-39
1N5350B	1N5350B		6-39

CF = consult factory representative

**CROSS-REFERENCE (continued)**

Industry Part Number	Motorola Direct Replacement	Motorola Similar Replacement	Page Number
1N5350C	CF		-
1N5350D	CF		-
1N5351	1N5351B		6-39
1N5351A	1N5351B		6-39
1N5351B	1N5351B		6-39
1N5351C	CF		-
1N5351D	CF		-
1N5352	1N5352B		6-39
1N5352A	1N5352B		6-39
1N5352B	1N5352B		6-39
1N5352C	CF		-
1N5352D	CF		-
1N5353	1N5353B		6-39
1N5353A	1N5353B		6-39
1N5353B	1N5353B		6-39
1N5353C	CF		-
1N5353D	CF		-
1N5354	1N5354B		6-39
1N5354A	1N5354B		6-39
1N5354B	1N5354B		6-39
1N5354C	CF		-
1N5354D	CF		-
1N5355	1N5355B		6-39
1N5355A	1N5355B		6-39
1N5355B	1N5355B		6-39
1N5355C	CF		-
1N5355D	CF		-
1N5356	1N5356B		6-39
1N5356A	1N5356B		6-39
1N5356B	1N5356B		6-39
1N5356C	CF		-
1N5356D	CF		-
1N5357	1N5357B		6-39
1N5357A	1N5357B		6-39
1N5357B	1N5357B		6-39
1N5357C	CF		-
1N5357D	CF		-
1N5358	1N5358B		6-39
1N5358A	1N5358B		6-39
1N5358B	1N5358B		6-39
1N5358C	CF		-
1N5358D	CF		-
1N5359	1N5359B		6-39
1N5359A	1N5359B		6-39
1N5359B	1N5359B		6-39
1N5359C	CF		-
1N5359D	CF		-
1N5360	1N5360B		6-39
1N5360A	1N5360B		6-39
1N5360B	1N5360B		6-39

Industry Part Number	Motorola Direct Replacement	Motorola Similar Replacement	Page Number
1N5360C	CF		-
1N5360D	CF		-
1N5361	1N5361B		6-39
1N5361A	1N5361B		6-39
1N5361B	1N5361B		6-39
1N5361C	CF		-
1N5361D	CF		-
1N5362	1N5362B		6-39
1N5362A	1N5362B		6-39
1N5362B	1N5362B		6-39
1N5362C	CF		-
1N5362D	CF		-
1N5363	1N5363B		6-39
1N5363A	1N5363B		6-39
1N5363B	1N5363B		6-39
1N5363C	CF		-
1N5363D	CF		-
1N5364	1N5364B		6-39
1N5364A	1N5364B		6-39
1N5364B	1N5364B		6-39
1N5364C	CF		-
1N5364D	CF		-
1N5365	1N5365B		6-39
1N5365A	1N5365B		6-39
1N5365B	1N5365B		6-39
1N5365C	CF		-
1N5365D	CF		-
1N5366	1N5366B		6-39
1N5366A	1N5366B		6-39
1N5366B	1N5366B		6-39
1N5366C	CF		-
1N5366D	CF		-
1N5367	1N5367B		6-39
1N5367A	1N5367B		6-39
1N5367B	1N5367B		6-39
1N5367C	CF		-
1N5367D	CF		-
1N5368	1N5368B		6-39
1N5368A	1N5368B		6-39
1N5368B	1N5368B		6-39
1N5368C	CF		-
1N5368D	CF		-
1N5369	1N5369B		6-39
1N5369A	1N5369B		6-39
1N5369B	1N5369B		6-39
1N5369C	CF		-
1N5369D	CF		-
1N5370	1N5370B		6-39
1N5370A	1N5370B		6-39
1N5370B	1N5370B		6-39

CF = consult factory representative

**CROSS-REFERENCE (continued)**

Industry Part Number	Motorola Direct Replacement	Motorola Similar Replacement	Page Number
1N5370C	CF		-
1N5370D	CF		-
1N5371	1N5371B		6-39
1N5371A	1N5371B		6-39
1N5371B	1N5371B		6-39
1N5371C	CF		-
1N5371D	CF		-
1N5372	1N5372B		6-39
1N5372A	1N5372B		6-39
1N5372B	1N5372B		6-39
1N5372C	CF		-
1N5372D	CF		-
1N5373	1N5373B		6-39
1N5373A	1N5373B		6-39
1N5373B	1N5373B		6-39
1N5373C	CF		-
1N5373D	CF		-
1N5374	1N5374B		6-39
1N5374A	1N5374B		6-39
1N5374B	1N5374B		6-39
1N5374C	CF		-
1N5374D	CF		-
1N5375	1N5375B		6-39
1N5375A	1N5375B		6-39
1N5375B	1N5375B		6-39
1N5375C	CF		-
1N5375D	CF		-
1N5376	1N5376B		6-39
1N5376A	1N5376B		6-39
1N5376B	1N5376B		6-39
1N5376C	CF		-
1N5376D	CF		-
1N5377	1N5377B		6-39
1N5377A	1N5377B		6-39
1N5377B	1N5377B		6-39
1N5377C	CF		-
1N5377D	CF		-
1N5378	1N5378B		6-39
1N5378A	1N5378B		6-39
1N5378B	1N5378B		6-39
1N5378C	CF		-
1N5378D	CF		-
1N5379	1N5379B		6-39
1N5379A	1N5379B		6-39
1N5379B	1N5379B		6-39
1N5379C	CF		-
1N5379D	CF		-
1N5380	1N5380B		6-39
1N5380A	1N5380B		6-39
1N5380B	1N5380B		6-39

Industry Part Number	Motorola Direct Replacement	Motorola Similar Replacement	Page Number
1N5380C	CF		-
1N5380D	CF		-
1N5381	1N5381B		6-39
1N5381A	1N5381B		6-39
1N5381B	1N5381B		6-39
1N5381C	CF		-
1N5381D	CF		-
1N5382	1N5382B		6-39
1N5382A	1N5382B		6-39
1N5382B	1N5382B		6-39
1N5382C	CF		-
1N5382D	CF		-
1N5383	1N5383B		6-40
1N5383A	1N5383B		6-40
1N5383B	1N5383B		6-40
1N5383C	CF		-
1N5383D	CF		-
1N5384	1N5384B		6-40
1N5384A	1N5384B		6-40
1N5384B	1N5384B		6-40
1N5384C	CF		-
1N5384D	CF		-
1N5385	1N5385B		6-40
1N5385A	1N5385B		6-40
1N5385B	1N5385B		6-40
1N5385C	CF		-
1N5385D	CF		-
1N5386	1N5386B		6-40
1N5386A	1N5386B		6-40
1N5386B	1N5386B		6-40
1N5386C	CF		-
1N5386D	CF		-
1N5387	1N5387B		6-40
1N5387A	1N5387B		6-40
1N5387B	1N5387B		6-40
1N5387C	CF		-
1N5387D	CF		-
1N5388	1N5388B		6-40
1N5388A	1N5388B		6-40
1N5388B	1N5388B		6-40
1N5388C	CF		-
1N5388D	CF		-
1N5518		1N5226B	6-11
1N5518A		1N5226B	6-11
1N5518B		1N5226B	6-11
1N5518C		1N5226C	6-11
1N5518D		1N5226D	6-11
1N5519		1N5227B	6-11
1N5519A		1N5227B	6-11
1N5519B		1N5227B	6-11

CF = consult factory representative

**CROSS-REFERENCE (continued)**

Industry Part Number	Motorola Direct Replacement	Motorola Similar Replacement	Page Number
1N5519C		1N5227C	6-11
1N5519D		1N5227D	6-11
1N5520		MZ5520B	6-18
1N5520A		MZ5520B	6-18
1N5520B		MZ5520B	6-18
1N5520C		CF	-
1N5520D		CF	-
1N5521		MZ5521B	6-18
1N5521A		MZ5521B	6-18
1N5521B		MZ5521B	6-18
1N5521C		CF	-
1N5521D		CF	-
1N5522		MZ5522B	6-18
1N5522A		MZ5522B	6-18
1N5522B		MZ5522B	6-18
1N5522C		CF	-
1N5522D		CF	-
1N5523		MZ5523B	6-18
1N5523A		MZ5523B	6-18
1N5523B		MZ5523B	6-18
1N5523C		CF	-
1N5523D		CF	-
1N5524		MZ5524B	6-18
1N5524A		MZ5524B	6-18
1N5524B		MZ5524B	6-18
1N5524C		CF	-
1N5524D		CF	-
1N5525		MZ5525B	6-18
1N5525A		MZ5525B	6-18
1N5525B		MZ5525B	6-18
1N5525C		CF	-
1N5525D		CF	-
1N5526		MZ5526B	6-18
1N5526A		MZ5526B	6-18
1N5526B		MZ5526B	6-18
1N5526C		CF	-
1N5526D		CF	-
1N5527		MZ5527B	6-18
1N5527A		MZ5527B	6-18
1N5527B		MZ5527B	6-18
1N5527C		CF	-
1N5527D		CF	-
1N5528		MZ5528B	6-18
1N5528A		MZ5528B	6-18
1N5528B		MZ5528B	6-18
1N5528C		CF	-
1N5528D		CF	-
1N5529		MZ5529B	6-18
1N5529A		MZ5529B	6-18
1N5529B		MZ5529B	6-18

Industry Part Number	Motorola Direct Replacement	Motorola Similar Replacement	Page Number
1N5529C		CF	-
1N5529D		CF	-
1N5530		MZ5530B	6-18
1N5530A		MZ5530B	6-18
1N5530B		MZ5530B	6-18
1N5530C		CF	-
1N5530D		CF	-
1N5531		1N4698	6-10
1N5531A		1N4698	6-10
1N5531B		1N4698	6-10
1N5531C		1N4698C	6-10
1N5531D		1N4698D	6-10
1N5532		1N4699	6-10
1N5532A		1N4699	6-10
1N5532B		1N4699	6-10
1N5532C		1N4699C	6-10
1N5532D		1N4699D	6-10
1N5533		1N4700	6-10
1N5533A		1N4700	6-10
1N5533B		1N4700	6-10
1N5533C		1N4700C	6-10
1N5533D		1N4700D	6-10
1N5534		1N4701	6-10
1N5534A		1N4701	6-10
1N5534B		1N4701	6-10
1N5534C		1N4701C	6-10
1N5534D		1N4701D	6-10
1N5535		1N4702	6-10
1N5535A		1N4702	6-10
1N5535B		1N4702	6-10
1N5535C		1N4702C	6-10
1N5535D		1N4702D	6-10
1N5536		1N4703	6-10
1N5536A		1N4703	6-10
1N5536B		1N4703	6-10
1N5536C		1N4703C	6-10
1N5536D		1N4703D	6-10
1N5537		1N4704	6-10
1N5537A		1N4704	6-10
1N5537B		1N4704	6-10
1N5537C		1N4704C	6-10
1N5537D		1N4704D	6-10
1N5538		1N4705	6-10
1N5538A		1N4705	6-10
1N5538B		1N4705	6-10
1N5538C		1N4705C	6-10
1N5538D		1N4705D	6-10
1N5539		1N4706	6-10
1N5539A		1N4706	6-10
1N5539B		1N4706	6-10

CF = consult factory representative

**CROSS-REFERENCE (continued)**

Industry Part Number	Motorola Direct Replacement	Motorola Similar Replacement	Page Number
1N5539C		1N4706C	6-10
1N5539D		1N4706D	6-10
1N5540		1N4707	6-10
1N5540A		1N4707	6-10
1N5540B		1N4707	6-10
1N5540C		1N4707C	6-10
1N5540D		1N4707D	6-10
1N5541		1N4708	6-10
1N5541A		1N4708	6-10
1N5541B		1N4708	6-10
1N5541C		1N4708C	6-10
1N5541D		1N4708D	6-10
1N5542		1N4709	6-10
1N5542A		1N4709	6-10
1N5542B		1N4709	6-10
1N5542C		1N4709C	6-10
1N5542D		1N4709D	6-10
1N5543		1N4710	6-10
1N5543A		1N4710	6-10
1N5543B		1N4710	6-10
1N5543C		1N4710C	6-10
1N5543D		1N4710D	6-10
1N5544		1N4712	6-10
1N5544A		1N4712	6-10
1N5544B		1N4712	6-10
1N5544C		1N4712C	6-10
1N5544D		1N4712D	6-10
1N5545		1N4713	6-10
1N5545A		1N4713	6-10
1N5545B		1N4713	6-10
1N5545C		1N4713C	6-10
1N5545D		1N4713D	6-10
1N5546		1N4714	6-10
1N5546A		1N4714	6-10
1N5546B		1N4714	6-10
1N5546C		1N4714C	6-10
1N5546D		1N4714D	6-10
1N5555		1N6284A	4-17
1N5556		1N6287A	4-17
1N5557		1N6289A	4-17
1N5558		1N6303A	4-17
1N5559		1N4736A	6-24
1N5559A		1N4736A	6-24
1N5559B		1N4736A	6-24
1N5560		1N4737A	6-24
1N5560A		1N4737A	6-24
1N5560B		1N4737A	6-24
1N5561		1N4738A	6-24
1N5561A		1N4738A	6-24
1N5561B		1N4738A	6-24

Industry Part Number	Motorola Direct Replacement	Motorola Similar Replacement	Page Number
1N5562		1N4739A	6-24
1N5562A		1N4739A	6-24
1N5562B		1N4739A	6-24
1N5563		1N4740A	6-24
1N5563A		1N4740A	6-24
1N5563B		1N4740A	6-24
1N5564		1N4741A	6-24
1N5564A		1N4741A	6-24
1N5564B		1N4741A	6-24
1N5565		1N4742A	6-24
1N5565A		1N4742A	6-24
1N5565B		1N4742A	6-24
1N5566		1N4743A	6-24
1N5566A		1N4743A	6-24
1N5566B		1N4743A	6-24
1N5567		1N4744A	6-24
1N5567A		1N4744A	6-24
1N5567B		1N4744A	6-24
1N5568		1N4745A	6-24
1N5568A		1N4745A	6-24
1N5568B		1N4745A	6-24
1N5569		1N4746A	6-24
1N5569A		1N4746A	6-24
1N5569B		1N4746A	6-24
1N5570		1N4747A	6-24
1N5570A		1N4747A	6-24
1N5570B		1N4747A	6-24
1N5571		1N4748A	6-24
1N5571A		1N4748A	6-24
1N5571B		1N4748A	6-24
1N5572		1N4749A	6-24
1N5572A		1N4749A	6-24
1N5572B		1N4749A	6-24
1N5573		1N4750A	6-24
1N5573A		1N4750A	6-24
1N5573B		1N4750A	6-24
1N5574		1N4751A	6-24
1N5574A		1N4751A	6-24
1N5574B		1N4751A	6-24
1N5575		1N4752A	6-24
1N5575A		1N4752A	6-24
1N5575B		1N4752A	6-24
1N5576		1N4753A	6-24
1N5576A		1N4753A	6-24
1N5576B		1N4753A	6-24
1N5577		1N4754A	6-24
1N5577A		1N4754A	6-24
1N5577B		1N4754A	6-24
1N5578		1N4755A	6-24
1N5578A		1N4755A	6-24

CF = consult factory representative

**CROSS-REFERENCE (continued)**

Industry Part Number	Motorola Direct Replacement	Motorola Similar Replacement	Page Number
1N5578B		1N4755A	6-24
1N5579		1N4756A	6-24
1N5579A		1N4756A	6-24
1N5579B		1N4756A	6-24
1N5580		1N4757A	6-24
1N5580A		1N4757A	6-24
1N5580B		1N4757A	6-24
1N5581		1N4758A	6-24
1N5581A		1N4758A	6-24
1N5581B		1N4758A	6-24
1N5582		1N4759A	6-24
1N5582A		1N4759A	6-24
1N5582B		1N4759A	6-24
1N5583		1N4760A	6-24
1N5583A		1N4760A	6-24
1N5583B		1N4760A	6-24
1N5584		1N4761A	6-24
1N5584A		1N4761A	6-24
1N5584B		1N4761A	6-24
1N5585		1N4762A	6-24
1N5585A		1N4762A	6-24
1N5585B		1N4762A	6-24
1N5586		1N4763A	6-24
1N5586A		1N4763A	6-24
1N5586B		1N4763A	6-24
1N5587		1N4764A	6-24
1N5587A		1N4764A	6-24
1N5587B		1N4764A	6-24
1N5588		1M110ZS5	6-36
1N5588A		1M110ZS5	6-36
1N5588B		1M110ZS5	6-36
1N5589		1M120ZS5	6-36
1N5589A		1M120ZS5	6-36
1N5589B		1M120ZS5	6-36
1N5590		1M130ZS5	6-36
1N5590A		1M130ZS5	6-36
1N5590B		1M130ZS5	6-36
1N5591		1M150ZS5	6-36
1N5591A		1M150ZS5	6-36
1N5591B		1M150ZS5	6-36
1N5592		1M160ZS5	6-36
1N5592A		1M160ZS5	6-36
1N5592B		1M160ZS5	6-36
1N5593		1M180ZS5	6-36
1N5593A		1M180ZS5	6-36
1N5593B		1M180ZS5	6-36
1N5594		1M200ZS5	6-36
1N5594A		1M200ZS5	6-36
1N5594B		1M200ZS5	6-36
1N5610		1N6284A	4-17

Industry Part Number	Motorola Direct Replacement	Motorola Similar Replacement	Page Number
1N5611		1N6287A	4-17
1N5612		1N6289A	4-17
1N5613		1N6303A	4-17
1N5629		1N6267A	4-17
1N5629A		1N6267A	4-17
1N5630		1N6268A	4-17
1N5630A		1N6268A	4-17
1N5631		1N6269A	4-17
1N5631A		1N6269A	4-17
1N5632		1N6270A	4-17
1N5632A		1N6270A	4-17
1N5633		1N6271A	4-17
1N5633A		1N6271A	4-17
1N5634		1N6272A	4-17
1N5634A		1N6272A	4-17
1N5635		1N6273A	4-17
1N5635A		1N6273A	4-17
1N5636		1N6274A	4-17
1N5636A		1N6274A	4-17
1N5637		1N6275A	4-17
1N5637A		1N6275A	4-17
1N5638		1N6276A	4-17
1N5638A		1N6276A	4-17
1N5639		1N6277A	4-17
1N5639A		1N6277A	4-17
1N5640		1N6278A	4-17
1N5640A		1N6278A	4-17
1N5641		1N6279A	4-17
1N5641A		1N6279A	4-17
1N5642		1N6280A	4-17
1N5642A		1N6280A	4-17
1N5643		1N6281A	4-17
1N5643A		1N6281A	4-17
1N5644		1N6282A	4-17
1N5644A		1N6282A	4-17
1N5645		1N6283A	4-17
1N5645A		1N6283A	4-17
1N5646		1N6284A	4-17
1N5646A		1N6284A	4-17
1N5647		1N6285A	4-17
1N5647A		1N6285A	4-17
1N5648		1N6286A	4-17
1N5648A		1N6286A	4-17
1N5649		1N6287A	4-17
1N5649A		1N6287A	4-17
1N5650		1N6288A	4-17
1N5650A		1N6288A	4-17
1N5651		1N6289A	4-17
1N5651A		1N6289A	4-17
1N5652		1N6290A	4-17

CF = consult factory representative

**CROSS-REFERENCE (continued)**

Industry Part Number	Motorola Direct Replacement	Motorola Similar Replacement	Page Number
1N5652A		1N6290A	4-17
1N5653		1N6291A	4-17
1N5653A		1N6291A	4-17
1N5654		1N6292A	4-17
1N5654A		1N6292A	4-17
1N5655		1N6293A	4-17
1N5655A		1N6293A	4-17
1N5656		1N6294A	4-17
1N5656A		1N6294A	4-17
1N5657		1N6295A	4-17
1N5657A		1N6295A	4-17
1N5658		1N6296A	4-17
1N5658A		1N6296A	4-17
1N5659		1N6297A	4-17
1N5659A		1N6297A	4-17
1N5660		1N6298A	4-17
1N5660A		1N6298A	4-17
1N5661		1N6299A	4-17
1N5661A		1N6299A	4-17
1N5662		1N6300A	4-17
1N5662A		1N6300A	4-17
1N5663		1N6301A	4-17
1N5663A		1N6301A	4-17
1N5664		1N6302A	4-17
1N5664A		1N6302A	4-17
1N5665		1N6303A	4-17
1N5665A		1N6303A	4-17
1N5728B		1N5992B	6-13
1N5728C		1N5992C	6-13
1N5728D		1N5992D	6-13
1N5729B		1N5993B	6-13
1N5729C		1N5993C	6-13
1N5729D		1N5993D	6-13
1N5730B		1N5994B	6-13
1N5730C		1N5994C	6-13
1N5730D		1N5994D	6-13
1N5731B		1N5995B	6-13
1N5731C		1N5995C	6-13
1N5731D		1N5995D	6-13
1N5732B		1N5996B	6-13
1N5732C		1N5996C	6-13
1N5732D		1N5996D	6-13
1N5733B		1N5997B	6-13
1N5733C		1N5997C	6-13
1N5733D		1N5997D	6-13
1N5734B		1N5998B	6-13
1N5734C		1N5998C	6-13
1N5734D		1N5998D	6-13
1N5735B		1N5999B	6-13
1N5735C		1N5999C	6-13

Industry Part Number	Motorola Direct Replacement	Motorola Similar Replacement	Page Number
1N5735D		1N5999D	6-13
1N5736B		1N6000B	6-13
1N5736C		1N6000C	6-13
1N5736D		1N6000D	6-13
1N5737B		1N6001B	6-13
1N5737C		1N6001C	6-13
1N5737D		1N6001D	6-13
1N5738B		1N6002B	6-13
1N5738C		1N6002C	6-13
1N5738D		1N6002D	6-13
1N5739B		1N6003B	6-13
1N5739C		1N6003C	6-13
1N5739D		1N6003D	6-13
1N5740B		1N6004B	6-13
1N5740C		1N6004C	6-13
1N5740D		1N6004D	6-13
1N5741B		1N6005B	6-13
1N5741C		1N6005C	6-13
1N5741D		1N6005D	6-13
1N5742B		1N6006B	6-13
1N5742C		1N6006C	6-13
1N5742D		1N6006D	6-13
1N5743B		1N6007B	6-13
1N5743C		1N6007C	6-13
1N5743D		1N6007D	6-13
1N5744B		1N6008B	6-13
1N5744C		1N6008C	6-13
1N5744D		1N6008D	6-13
1N5745B		1N6009B	6-13
1N5745C		1N6009C	6-13
1N5745D		1N6009D	6-13
1N5746B		1N6010B	6-13
1N5746C		1N6010C	6-13
1N5746D		1N6010D	6-13
1N5747B		1N6011B	6-13
1N5747C		1N6011C	6-13
1N5747D		1N6011D	6-13
1N5748B		1N6012B	6-13
1N5748C		1N6012C	6-13
1N5748D		1N6012D	6-13
1N5749B		1N6013B	6-13
1N5749C		1N6013C	6-13
1N5749D		1N6013D	6-13
1N5750B		1N6014B	6-13
1N5750C		1N6014C	6-13
1N5750D		1N6014D	6-13
1N5751B		1N6015B	6-13
1N5751C		1N6015C	6-13
1N5751D		1N6015D	6-13
1N5752B		1N6016B	6-13

CF = consult factory representative

**CROSS-REFERENCE (continued)**

Industry Part Number	Motorola Direct Replacement	Motorola Similar Replacement	Page Number
1N5752C		1N6016C	6-13
1N5752D		1N6016D	6-13
1N5753B		1N6017B	6-13
1N5753C		1N6017C	6-13
1N5753D		1N6017D	6-13
1N5754B		1N6018B	6-13
1N5754C		1N6018C	6-13
1N5754D		1N6018D	6-13
1N5755B		1N6019B	6-13
1N5755C		1N6019C	6-13
1N5755D		1N6019D	6-13
1N5756B		1N6020B	6-13
1N5756C		1N6020C	6-13
1N5756D		1N6020D	6-13
1N5757B		1N6021B	6-13
1N5757C		1N6021C	6-13
1N5757D		1N6021D	6-13
1N5837		1N5221B	6-11
1N5837A		1N5221B	6-11
1N5837B		1N5221B	6-11
1N5838		1N5222B	6-11
1N5838A		1N5222B	6-11
1N5838B		1N5222B	6-11
1N5839		1N5223B	6-11
1N5839A		1N5223B	6-11
1N5839B		1N5223B	6-11
1N5840		1N5224B	6-11
1N5840A		1N5224B	6-11
1N5840B		1N5224B	6-11
1N5841		1N5225B	6-11
1N5841A		1N5225B	6-11
1N5841B		1N5225B	6-11
1N5842		1N5226B	6-11
1N5842A		1N5226B	6-11
1N5842B		1N5226B	6-11
1N5843		1N5227B	6-11
1N5843A		1N5227B	6-11
1N5843B		1N5227B	6-11
1N5844		1N5228B	6-11
1N5844A		1N5228B	6-11
1N5844B		1N5228B	6-11
1N5845		1N5229B	6-11
1N5845A		1N5229B	6-11
1N5845B		1N5229B	6-11
1N5846		1N5230B	6-11
1N5846A		1N5230B	6-11
1N5846B		1N5230B	6-11
1N5847		1N5231B	6-11
1N5847A		1N5231B	6-11
1N5847B		1N5231B	6-11

Industry Part Number	Motorola Direct Replacement	Motorola Similar Replacement	Page Number
1N5848		1N5232B	6-11
1N5848A		1N5232B	6-11
1N5848B		1N5232B	6-11
1N5849		1N5233B	6-11
1N5849A		1N5233B	6-11
1N5849B		1N5233B	6-11
1N5850		1N5234B	6-11
1N5850A		1N5234B	6-11
1N5850B		1N5234B	6-11
1N5851		1N5235B	6-11
1N5851A		1N5235B	6-11
1N5851B		1N5235B	6-11
1N5852		1N5236B	6-11
1N5852A		1N5236B	6-11
1N5852B		1N5236B	6-11
1N5853		1N5237B	6-11
1N5853A		1N5237B	6-11
1N5853B		1N5237B	6-11
1N5854		1N5238B	6-11
1N5854A		1N5238B	6-11
1N5854B		1N5238B	6-11
1N5855		1N5239B	6-11
1N5855A		1N5239B	6-11
1N5855B		1N5239B	6-11
1N5856		1N5240B	6-11
1N5856A		1N5240B	6-11
1N5856B		1N5240B	6-11
1N5857		1N5241B	6-11
1N5857A		1N5241B	6-11
1N5857B		1N5241B	6-11
1N5858		1N5242B	6-11
1N5858A		1N5242B	6-11
1N5858B		1N5242B	6-11
1N5859		1N5243B	6-11
1N5859A		1N5243B	6-11
1N5859B		1N5243B	6-11
1N5860		1N5244B	6-11
1N5860A		1N5244B	6-11
1N5860B		1N5244B	6-11
1N5861		1N5245B	6-11
1N5861A		1N5245B	6-11
1N5861B		1N5245B	6-11
1N5862		1N5246B	6-11
1N5862A		1N5246B	6-11
1N5862B		1N5246B	6-11
1N5863		1N5247B	6-11
1N5863A		1N5247B	6-11
1N5863B		1N5247B	6-11
1N5864		1N5248B	6-11
1N5864A		1N5248B	6-11

CF = consult factory representative



**CROSS-REFERENCE (continued)**

Industry Part Number	Motorola Direct Replacement	Motorola Similar Replacement	Page Number
1N5864B		1N5248B	6-11
1N5865		1N5249B	6-11
1N5865A		1N5249B	6-11
1N5865B		1N5249B	6-11
1N5866		1N5250B	6-11
1N5866A		1N5250B	6-11
1N5866B		1N5250B	6-11
1N5867		1N5251B	6-11
1N5867A		1N5251B	6-11
1N5867B		1N5251B	6-11
1N5868		1N5252B	6-11
1N5868A		1N5252B	6-11
1N5868B		1N5252B	6-11
1N5869		1N5253B	6-11
1N5869A		1N5253B	6-11
1N5869B		1N5253B	6-11
1N5870		1N5254B	6-11
1N5870A		1N5254B	6-11
1N5870B		1N5254B	6-11
1N5871		1N5255B	6-11
1N5871A		1N5255B	6-11
1N5871B		1N5255B	6-11
1N5872		1N5256B	6-11
1N5872A		1N5256B	6-11
1N5872B		1N5256B	6-11
1N5873		1N5257B	6-11
1N5873A		1N5257B	6-11
1N5873B		1N5257B	6-11
1N5874		1N5258B	6-11
1N5874A		1N5258B	6-11
1N5874B		1N5258B	6-11
1N5875		1N5259B	6-11
1N5875A		1N5259B	6-11
1N5875B		1N5259B	6-11
1N5876		1N5260B	6-11
1N5876A		1N5260B	6-11
1N5876B		1N5260B	6-11
1N5877		1N5261B	6-11
1N5877A		1N5261B	6-11
1N5877B		1N5261B	6-11
1N5878		1N5262B	6-11
1N5878A		1N5262B	6-11
1N5878B		1N5262B	6-11
1N5879		1N5263B	6-11
1N5879A		1N5263B	6-11
1N5879B		1N5263B	6-11
1N5880		1N5264B	6-11
1N5880A		1N5264B	6-11
1N5880B		1N5264B	6-11
1N5881		1N5265B	6-11

Industry Part Number	Motorola Direct Replacement	Motorola Similar Replacement	Page Number
1N5881A		1N5265B	6-11
1N5881B		1N5265B	6-11
1N5882		1N5266B	6-12
1N5882A		1N5266B	6-12
1N5882B		1N5266B	6-12
1N5883		1N5267B	6-12
1N5883A		1N5267B	6-12
1N5883B		1N5267B	6-12
1N5884		1N5268B	6-12
1N5884A		1N5268B	6-12
1N5884B		1N5268B	6-12
1N5885		1N5269B	6-12
1N5885A		1N5269B	6-12
1N5885B		1N5269B	6-12
1N5886		1N5270B	6-12
1N5886A		1N5270B	6-12
1N5886B		1N5270B	6-12
1N5887		1N5271B	6-12
1N5887A		1N5271B	6-12
1N5887B		1N5271B	6-12
1N5888		1N5272B	6-12
1N5888A		1N5272B	6-12
1N5888B		1N5272B	6-12
1N5889		1N5273B	6-12
1N5889A		1N5273B	6-12
1N5889B		1N5273B	6-12
1N5890		1N5274B	6-12
1N5890A		1N5274B	6-12
1N5890B		1N5274B	6-12
1N5891		1N5275B	6-12
1N5891A		1N5275B	6-12
1N5891B		1N5275B	6-12
1N5892		1N5276B	6-12
1N5892A		1N5276B	6-12
1N5892B		1N5276B	6-12
1N5893		1N5277B	6-12
1N5893A		1N5277B	6-12
1N5893B		1N5277B	6-12
1N5894		1N5278B	6-12
1N5894A		1N5278B	6-12
1N5894B		1N5278B	6-12
1N5895		1N5279B	6-12
1N5895A		1N5279B	6-12
1N5895B		1N5279B	6-12
1N5896		1N5280B	6-12
1N5896A		1N5280B	6-12
1N5896B		1N5280B	6-12
1N5897		1N5281B	6-12
1N5897A		1N5281B	6-12
1N5897B		1N5281B	6-12

CF = consult factory representative

**CROSS-REFERENCE (continued)**

Industry Part Number	Motorola Direct Replacement	Motorola Similar Replacement	Page Number
1N5907		1N5908	4-16
1N5908	1N5908		4-16
1N5913	1N5913B		6-31
1N5913A	1N5913B		6-31
1N5913B	1N5913B		6-31
1N5914	1N5914B		6-31
1N5914A	1N5914B		6-31
1N5914B	1N5914B		6-31
1N5915	1N5915B		6-31
1N5915A	1N5915B		6-31
1N5915B	1N5915B		6-31
1N5916	1N5916B		6-31
1N5916A	1N5916B		6-31
1N5916B	1N5916B		6-31
1N5917	1N5917B		6-31
1N5917A	1N5917B		6-31
1N5917B	1N5917B		6-31
1N5918	1N5918B		6-31
1N5918A	1N5918B		6-31
1N5918B	1N5918B		6-31
1N5919	1N5919B		6-31
1N5919A	1N5919B		6-31
1N5919B	1N5919B		6-31
1N5920	1N5920B		6-31
1N5920A	1N5920B		6-31
1N5920B	1N5920B		6-31
1N5921	1N5921B		6-31
1N5921A	1N5921B		6-31
1N5921B	1N5921B		6-31
1N5922	1N5922B		6-31
1N5922A	1N5922B		6-31
1N5922B	1N5922B		6-31
1N5923	1N5923B		6-31
1N5923A	1N5923B		6-31
1N5923B	1N5923B		6-31
1N5924	1N5924B		6-31
1N5924A	1N5924B		6-31
1N5924B	1N5924B		6-31
1N5925	1N5925B		6-31
1N5925A	1N5925B		6-31
1N5925B	1N5925B		6-31
1N5926	1N5926B		6-31
1N5926A	1N5926B		6-31
1N5926B	1N5926B		6-31
1N5927	1N5927B		6-31
1N5927A	1N5927B		6-31
1N5927B	1N5927B		6-31
1N5928	1N5928B		6-31
1N5928A	1N5928B		6-31
1N5928B	1N5928B		6-31

Industry Part Number	Motorola Direct Replacement	Motorola Similar Replacement	Page Number
1N5929	1N5929B		6-31
1N5929A	1N5929B		6-31
1N5929B	1N5929B		6-31
1N5930	1N5930B		6-31
1N5930A	1N5930B		6-31
1N5930B	1N5930B		6-31
1N5931	1N5931B		6-31
1N5931A	1N5931B		6-31
1N5931B	1N5931B		6-31
1N5932	1N5932B		6-31
1N5932A	1N5932B		6-31
1N5932B	1N5932B		6-31
1N5933	1N5933B		6-31
1N5933A	1N5933B		6-31
1N5933B	1N5933B		6-31
1N5934	1N5934B		6-31
1N5934A	1N5934B		6-31
1N5934B	1N5934B		6-31
1N5935	1N5935B		6-31
1N5935A	1N5935B		6-31
1N5935B	1N5935B		6-31
1N5936	1N5936B		6-31
1N5936A	1N5936B		6-31
1N5936B	1N5936B		6-31
1N5937	1N5937B		6-31
1N5937A	1N5937B		6-31
1N5937B	1N5937B		6-31
1N5938	1N5938B		6-31
1N5938A	1N5938B		6-31
1N5938B	1N5938B		6-31
1N5939	1N5939B		6-31
1N5939A	1N5939B		6-31
1N5939B	1N5939B		6-31
1N5940	1N5940B		6-31
1N5940A	1N5940B		6-31
1N5940B	1N5940B		6-31
1N5941	1N5941B		6-31
1N5941A	1N5941B		6-31
1N5941B	1N5941B		6-31
1N5942	1N5942B		6-31
1N5942A	1N5942B		6-31
1N5942B	1N5942B		6-31
1N5943	1N5943B		6-31
1N5943A	1N5943B		6-31
1N5943B	1N5943B		6-31
1N5944	1N5944B		6-31
1N5944A	1N5944B		6-31
1N5944B	1N5944B		6-31
1N5945	1N5945B		6-31
1N5945A	1N5945B		6-31

CF = consult factory representative

**CROSS-REFERENCE (continued)**

Industry Part Number	Motorola Direct Replacement	Motorola Similar Replacement	Page Number
1N5945B	1N5945B		6-31
1N5946	1N5946B		6-31
1N5946A	1N5946B		6-31
1N5946B	1N5946B		6-31
1N5947	1N5947B		6-31
1N5947A	1N5947B		6-31
1N5947B	1N5947B		6-31
1N5948	1N5948B		6-32
1N5948A	1N5948B		6-32
1N5948B	1N5948B		6-32
1N5949	1N5949B		6-32
1N5949A	1N5949B		6-32
1N5949B	1N5949B		6-32
1N5950	1N5950B		6-32
1N5950A	1N5950B		6-32
1N5950B	1N5950B		6-32
1N5951	1N5951B		6-32
1N5951A	1N5951B		6-32
1N5951B	1N5951B		6-32
1N5952	1N5952B		6-32
1N5952A	1N5952B		6-32
1N5952B	1N5952B		6-32
1N5953	1N5953B		6-32
1N5953A	1N5953B		6-32
1N5953B	1N5953B		6-32
1N5954	1N5954B		6-32
1N5954A	1N5954B		6-32
1N5954B	1N5954B		6-32
1N5955	1N5955B		6-32
1N5955A	1N5955B		6-32
1N5955B	1N5955B		6-32
1N5956	1N5956B		6-32
1N5956A	1N5956B		6-32
1N5956B	1N5956B		6-32
1N5985	1N5985B		6-13
1N5985A	1N5985B		6-13
1N5985B	1N5985B		6-13
1N5985C	1N5985C		6-13
1N5985D	1N5985D		6-13
1N5986	1N5986B		6-13
1N5986A	1N5986B		6-13
1N5986B	1N5986B		6-13
1N5986C	1N5986C		6-13
1N5986D	1N5986D		6-13
1N5987	1N5987B		6-13
1N5987A	1N5987B		6-13
1N5987B	1N5987B		6-13
1N5987C	1N5987C		6-13
1N5987D	1N5987D		6-13
1N5988	1N5988B		6-13

Industry Part Number	Motorola Direct Replacement	Motorola Similar Replacement	Page Number
1N5988A	1N5988B		6-13
1N5988B	1N5988B		6-13
1N5988C	1N5988C		6-13
1N5988D	1N5988D		6-13
1N5989	1N5989B		6-13
1N5989A	1N5989B		6-13
1N5989B	1N5989B		6-13
1N5989C	1N5989C		6-13
1N5989D	1N5989D		6-13
1N5990	1N5990B		6-13
1N5990A	1N5990B		6-13
1N5990B	1N5990B		6-13
1N5990C	1N5990C		6-13
1N5990D	1N5990D		6-13
1N5991	1N5991B		6-13
1N5991A	1N5991B		6-13
1N5991B	1N5991B		6-13
1N5991C	1N5991C		6-13
1N5991D	1N5991D		6-13
1N5992	1N5992B		6-13
1N5992A	1N5992B		6-13
1N5992B	1N5992B		6-13
1N5992C	1N5992C		6-13
1N5992D	1N5992D		6-13
1N5993	1N5993B		6-13
1N5993A	1N5993B		6-13
1N5993B	1N5993B		6-13
1N5993C	1N5993C		6-13
1N5993D	1N5993D		6-13
1N5994	1N5994B		6-13
1N5994A	1N5994B		6-13
1N5994B	1N5994B		6-13
1N5994C	1N5994C		6-13
1N5994D	1N5994D		6-13
1N5995	1N5995B		6-13
1N5995A	1N5995B		6-13
1N5995B	1N5995B		6-13
1N5995C	1N5995C		6-13
1N5995D	1N5995D		6-13
1N5996	1N5996B		6-13
1N5996A	1N5996B		6-13
1N5996B	1N5996B		6-13
1N5996C	1N5996C		6-13
1N5996D	1N5996D		6-13
1N5997	1N5997B		6-13
1N5997A	1N5997B		6-13
1N5997B	1N5997B		6-13
1N5997C	1N5997C		6-13
1N5997D	1N5997D		6-13
1N5998	1N5998B		6-13

CF = consult factory representative

**CROSS-REFERENCE (continued)**

Industry Part Number	Motorola Direct Replacement	Motorola Similar Replacement	Page Number
1N5998A	1N5998B		6-13
1N5998B	1N5998B		6-13
1N5998C	1N5998C		6-13
1N5998D	1N5998D		6-13
1N5999	1N5999B		6-13
1N5999A	1N5999B		6-13
1N5999B	1N5999B		6-13
1N5999C	1N5999C		6-13
1N5999D	1N5999D		6-13
1N6000	1N6000B		6-13
1N6000A	1N6000B		6-13
1N6000B	1N6000B		6-13
1N6000C	1N6000C		6-13
1N6000D	1N6000D		6-13
1N6001	1N6001B		6-13
1N6001A	1N6001B		6-13
1N6001B	1N6001B		6-13
1N6001C	1N6001C		6-13
1N6001D	1N6001D		6-13
1N6002	1N6002B		6-13
1N6002A	1N6002B		6-13
1N6002B	1N6002B		6-13
1N6002C	1N6002C		6-13
1N6002D	1N6002D		6-13
1N6003	1N6003B		6-13
1N6003A	1N6003B		6-13
1N6003B	1N6003B		6-13
1N6003C	1N6003C		6-13
1N6003D	1N6003D		6-13
1N6004	1N6004B		6-13
1N6004A	1N6004B		6-13
1N6004B	1N6004B		6-13
1N6004C	1N6004C		6-13
1N6004D	1N6004D		6-13
1N6005	1N6005B		6-13
1N6005A	1N6005B		6-13
1N6005B	1N6005B		6-13
1N6005C	1N6005C		6-13
1N6005D	1N6005D		6-13
1N6006	1N6006B		6-13
1N6006A	1N6006B		6-13
1N6006B	1N6006B		6-13
1N6006C	1N6006C		6-13
1N6006D	1N6006D		6-13
1N6007	1N6007B		6-13
1N6007A	1N6007B		6-13
1N6007B	1N6007B		6-13
1N6007C	1N6007C		6-13
1N6007D	1N6007D		6-13
1N6008	1N6008B		6-13

Industry Part Number	Motorola Direct Replacement	Motorola Similar Replacement	Page Number
1N6008A	1N6008B		6-13
1N6008B	1N6008B		6-13
1N6008C	1N6008C		6-13
1N6008D	1N6008D		6-13
1N6009	1N6009B		6-13
1N6009A	1N6009B		6-13
1N6009B	1N6009B		6-13
1N6009C	1N6009C		6-13
1N6009D	1N6009D		6-13
1N6010	1N6010B		6-13
1N6010A	1N6010B		6-13
1N6010B	1N6010B		6-13
1N6010C	1N6010C		6-13
1N6010D	1N6010D		6-13
1N6011	1N6011B		6-13
1N6011A	1N6011B		6-13
1N6011B	1N6011B		6-13
1N6011C	1N6011C		6-13
1N6011D	1N6011D		6-13
1N6012	1N6012B		6-13
1N6012A	1N6012B		6-13
1N6012B	1N6012B		6-13
1N6012C	1N6012C		6-13
1N6012D	1N6012D		6-13
1N6013	1N6013B		6-13
1N6013A	1N6013B		6-13
1N6013B	1N6013B		6-13
1N6013C	1N6013C		6-13
1N6013D	1N6013D		6-13
1N6014	1N6014B		6-13
1N6014A	1N6014B		6-13
1N6014B	1N6014B		6-13
1N6014C	1N6014C		6-13
1N6014D	1N6014D		6-13
1N6015	1N6015B		6-13
1N6015A	1N6015B		6-13
1N6015B	1N6015B		6-13
1N6015C	1N6015C		6-13
1N6015D	1N6015D		6-13
1N6016	1N6016B		6-13
1N6016A	1N6016B		6-13
1N6016B	1N6016B		6-13
1N6016C	1N6016C		6-13
1N6016D	1N6016D		6-13
1N6017	1N6017B		6-13
1N6017A	1N6017B		6-13
1N6017B	1N6017B		6-13
1N6017C	1N6017C		6-13
1N6017D	1N6017D		6-13
1N6018	1N6018B		6-13

CF = consult factory representative

**CROSS-REFERENCE (continued)**

Industry Part Number	Motorola Direct Replacement	Motorola Similar Replacement	Page Number
1N6018A	1N6018B		6-13
1N6018B	1N6018B		6-13
1N6018C	1N6018C		6-13
1N6018D	1N6018D		6-13
1N6019	1N6019B		6-13
1N6019A	1N6019B		6-13
1N6019B	1N6019B		6-13
1N6019C	1N6019C		6-13
1N6019D	1N6019D		6-13
1N6020	1N6020B		6-13
1N6020A	1N6020B		6-13
1N6020B	1N6020B		6-13
1N6020C	1N6020C		6-13
1N6020D	1N6020D		6-13
1N6021	1N6021B		6-13
1N6021A	1N6021B		6-13
1N6021B	1N6021B		6-13
1N6021C	1N6021C		6-13
1N6021D	1N6021D		6-13
1N6022	1N6022B		6-13
1N6022A	1N6022B		6-13
1N6022B	1N6022B		6-13
1N6022C	1N6022C		6-13
1N6022D	1N6022D		6-13
1N6023	1N6023B		6-13
1N6023A	1N6023B		6-13
1N6023B	1N6023B		6-13
1N6023C	1N6023C		6-13
1N6023D	1N6023D		6-13
1N6024	1N6024B		6-13
1N6024A	1N6024B		6-13
1N6024B	1N6024B		6-13
1N6024C	1N6024C		6-13
1N6024D	1N6024D		6-13
1N6025	1N6025B		6-13
1N6025A	1N6025B		6-13
1N6025B	1N6025B		6-13
1N6025C	1N6025C		6-13
1N6025D	1N6025D		6-13
1N6026		1N5273B	6-12
1N6026A		1N5273B	6-12
1N6026B		1N5273B	6-12
1N6027		1N5274B	6-12
1N6027A		1N5274B	6-12
1N6027B		1N5274B	6-12
1N6028		1N5276B	6-12
1N6028A		1N5276B	6-12
1N6028B		1N5276B	6-12
1N6029		1N5277B	6-12
1N6029A		1N5277B	6-12

Industry Part Number	Motorola Direct Replacement	Motorola Similar Replacement	Page Number
1N6029B		1N5277B	6-12
1N6030		1N5279B	6-12
1N6030A		1N5279B	6-12
1N6030B		1N5279B	6-12
1N6031		1N5281B	6-12
1N6031A		1N5281B	6-12
1N6031B		1N5281B	6-12
1N6036		1.5KE7.5CA	4-17
1N6036A		1.5KE7.5CA	4-17
1N6037		1.5KE8.2CA	4-17
1N6037A		1.5KE8.2CA	4-17
1N6038		1.5KE9.1CA	4-17
1N6038A		1.5KE9.1CA	4-17
1N6039		1.5KE10CA	4-17
1N6039A		1.5KE10CA	4-17
1N6040		1.5KE11CA	4-17
1N6040A		1.5KE11CA	4-17
1N6041		1.5KE12CA	4-17
1N6041A		1.5KE12CA	4-17
1N6042		1.5KE13CA	4-17
1N6042A		1.5KE13CA	4-17
1N6043		1.5KE15CA	4-17
1N6043A		1.5KE15CA	4-17
1N6044		1.5KE16CA	4-17
1N6044A		1.5KE16CA	4-17
1N6045		1.5KE18CA	4-17
1N6045A		1.5KE18CA	4-17
1N6046		1.5KE20CA	4-17
1N6046A		1.5KE20CA	4-17
1N6047		1.5KE22CA	4-17
1N6047A		1.5KE22CA	4-17
1N6048		1.5KE24CA	4-17
1N6048A		1.5KE24CA	4-17
1N6049		1.5KE27CA	4-17
1N6049A		1.5KE27CA	4-17
1N6050		1.5KE30CA	4-17
1N6050A		1.5KE30CA	4-17
1N6051		1.5KE33CA	4-17
1N6051A		1.5KE33CA	4-17
1N6052		1.5KE36CA	4-17
1N6052A		1.5KE36CA	4-17
1N6053		1.5KE39CA	4-17
1N6053A		1.5KE39CA	4-17
1N6054		1.5KE43CA	4-17
1N6054A		1.5KE43CA	4-17
1N6055		1.5KE47CA	4-17
1N6055A		1.5KE47CA	4-17
1N6056		1.5KE51CA	4-17
1N6056A		1.5KE51CA	4-17
1N6057		1.5KE56CA	4-17

CF = consult factory representative

**CROSS-REFERENCE (continued)**

Industry Part Number	Motorola Direct Replacement	Motorola Similar Replacement	Page Number
1N6057A		1.5KE56CA	4-17
1N6058		1.5KE62CA	4-17
1N6058A		1.5KE62CA	4-17
1N6059		1.5KE68CA	4-17
1N6059A		1.5KE68CA	4-17
1N6060		1.5KE75CA	4-17
1N6060A		1.5KE75CA	4-17
1N6061		1.5KE82CA	4-17
1N6061A		1.5KE82CA	4-17
1N6062		1.5KE91CA	4-17
1N6062A		1.5KE91CA	4-17
1N6063		1.5KE100CA	4-17
1N6063A		1.5KE100CA	4-17
1N6064		1.5KE110CA	4-17
1N6064A		1.5KE110CA	4-17
1N6065		1.5KE120CA	4-17
1N6065A		1.5KE120CA	4-17
1N6066		1.5KE130CA	4-17
1N6066A		1.5KE130CA	4-17
1N6067		1.5KE150CA	4-17
1N6067A		1.5KE150CA	4-17
1N6068		1.5KE170CA	4-17
1N6068A		1.5KE170CA	4-17
1N6069		1.5KE180CA	4-17
1N6069A		1.5KE180CA	4-17
1N6070		1.5KE200CA	4-17
1N6070A		1.5KE200CA	4-17
1N6071		1.5KE200CA	4-17
1N6071A		1.5KE200CA	4-17
1N6072		1.5KE220CA	4-17
1N6072A		1.5KE220CA	4-17
1N6082		MZ5521B	6-18
1N6083		MZ5522B	6-18
1N6084		MZ5523B	6-18
1N6085		MZ5524B	6-18
1N6086		MZ5525B	6-18
1N6087		MZ5526B	6-18
1N6088		MZ5527B	6-18
1N6089		MZ5528B	6-18
1N6090		MZ5529B	6-18
1N6091		MZ5530B	6-18
1N6102A		SA6.0CA	4-3
1N6103A		SA6.5CA	4-3
1N6104A		SA7.0CA	4-3
1N6105A		SA7.5CA	4-3
1N6106A		SA8.5CA	4-3
1N6107A		SA9.0CA	4-3
1N6108A		SA10CA	4-3
1N6109A		SA11CA	4-3
1N6110A		SA12CA	4-3

Industry Part Number	Motorola Direct Replacement	Motorola Similar Replacement	Page Number
1N6111A		SA13CA	4-3
1N6112A		SA15CA	4-3
1N6113A		SA17CA	4-3
1N6114A		SA18CA	4-3
1N6115A		SA20CA	4-3
1N6116A		SA22CA	4-3
1N6117A		SA24CA	4-3
1N6118A		SA28CA	4-3
1N6119A		SA30CA	4-3
1N6120A		SA33CA	4-3
1N6121A		SA36CA	4-3
1N6122A		SA40CA	4-3
1N6123A		SA43CA	4-3
1N6124A		SA48CA	4-3
1N6125A		SA51CA	4-3
1N6126A		SA58CA	4-3
1N6127A		SA64CA	4-3
1N6128A		SA70CA	4-3
1N6129A		SA75CA	4-3
1N6130A		SA85CA	4-3
1N6131A		SA90CA	4-3
1N6132A		SA100CA	4-3
1N6133A		SA110CA	4-3
1N6134A		SA120CA	4-3
1N6135A		SA130CA	4-3
1N6136A		SA150CA	4-3
1N6137A		SA170CA	4-3
1N6138A		1.5KE6.8CA	4-17
1N6139A		1.5KE7.5CA	4-17
1N6140A		1.5KE8.2CA	4-17
1N6141A		1.5KE9.1CA	4-17
1N6142A		1.5KE10CA	4-17
1N6143A		1.5KE11CA	4-17
1N6144A		1.5KE12CA	4-17
1N6145A		1.5KE13CA	4-17
1N6146A		1.5KE15CA	4-17
1N6147A		1.5KE16CA	4-17
1N6148A		1.5KE18CA	4-17
1N6149A		1.5KE20CA	4-17
1N6150A		1.5KE22CA	4-17
1N6151A		1.5KE24CA	4-17
1N6152A		1.5KE27CA	4-17
1N6153A		1.5KE30CA	4-17
1N6154A		1.5KE33CA	4-17
1N6155A		1.5KE36CA	4-17
1N6156A		1.5KE39CA	4-17
1N6157A		1.5KE43CA	4-17
1N6158A		1.5KE47CA	4-17
1N6159A		1.5KE51CA	4-17
1N6160A		1.5KE56CA	4-17

CF = consult factory representative

**CROSS-REFERENCE (continued)**

Industry Part Number	Motorola Direct Replacement	Motorola Similar Replacement	Page Number
1N6161A		1.5KE62CA	4-17
1N6162A		1.5KE68CA	4-17
1N6163A		1.5KE75CA	4-17
1N6164A		1.5KE82CA	4-17
1N6165A		1.5KE91CA	4-17
1N6166A		1.5KE100CA	4-17
1N6167A		1.5KE110CA	4-17
1N6168A		1.5KE120CA	4-17
1N6169A		1.5KE130CA	4-17
1N6170A		1.5KE150CA	4-17
1N6171A		1.5KE160CA	4-17
1N6172A		1.5KE180CA	4-17
1N6173A		1.5KE200CA	4-17
1N6267	1N6267A		4-17
1N6267A	1N6267A		4-17
1N6268	1N6268A		4-17
1N6268A	1N6268A		4-17
1N6269	1N6269A		4-17
1N6269A	1N6269A		4-17
1N6270	1N6270A		4-17
1N6270A	1N6270A		4-17
1N6271	1N6271A		4-17
1N6271A	1N6271A		4-17
1N6272	1N6272A		4-17
1N6272A	1N6272A		4-17
1N6273	1N6273A		4-17
1N6273A	1N6273A		4-17
1N6274	1N6274A		4-17
1N6274A	1N6274A		4-17
1N6275	1N6275A		4-17
1N6275A	1N6275A		4-17
1N6276	1N6276A		4-17
1N6276A	1N6276A		4-17
1N6277	1N6277A		4-17
1N6277A	1N6277A		4-17
1N6278	1N6278A		4-17
1N6278A	1N6278A		4-17
1N6279	1N6279A		4-17
1N6279A	1N6279A		4-17
1N6280	1N6280A		4-17
1N6280A	1N6280A		4-17
1N6281	1N6281A		4-17
1N6281A	1N6281A		4-17
1N6282	1N6282A		4-17
1N6282A	1N6282A		4-17
1N6283	1N6283A		4-17
1N6283A	1N6283A		4-17
1N6284	1N6284A		4-17
1N6284A	1N6284A		4-17
1N6285	1N6285A		4-17

Industry Part Number	Motorola Direct Replacement	Motorola Similar Replacement	Page Number
1N6285A	1N6285A		4-17
1N6286	1N6286A		4-17
1N6286A	1N6286A		4-17
1N6287	1N6287A		4-17
1N6287A	1N6287A		4-17
1N6288	1N6288A		4-17
1N6288A	1N6288A		4-17
1N6289	1N6289A		4-17
1N6289A	1N6289A		4-17
1N6290	1N6290A		4-17
1N6290A	1N6290A		4-17
1N6291	1N6291A		4-17
1N6291A	1N6291A		4-17
1N6292	1N6292A		4-17
1N6292A	1N6292A		4-17
1N6293	1N6293A		4-17
1N6293A	1N6293A		4-17
1N6294	1N6294A		4-17
1N6294A	1N6294A		4-17
1N6295	1N6295A		4-17
1N6295A	1N6295A		4-17
1N6296	1N6296A		4-17
1N6296A	1N6296A		4-17
1N6297	1N6297A		4-17
1N6297A	1N6297A		4-17
1N6298	1N6298A		4-17
1N6298A	1N6298A		4-17
1N6299	1N6299A		4-17
1N6299A	1N6299A		4-17
1N6300	1N6300A		4-17
1N6300A	1N6300A		4-17
1N6301	1N6301A		4-17
1N6301A	1N6301A		4-17
1N6302	1N6302A		4-17
1N6302A	1N6302A		4-17
1N6303	1N6303A		4-17
1N6303A	1N6303A		4-17
1N6356		1N6373	4-19
1N6357		1N6374	4-19
1N6358		1N6375	4-19
1N6359		1N6376	4-19
1N6360		1N6377	4-19
1N6361		1N6378	4-19
1N6362		1N6379	4-19
1N6363		1N6380	4-19
1N6364		1N6381	4-19
1N6365		1N6382	4-19
1N6366		1N6383	4-19
1N6367		1N6384	4-19
1N6368		1N6385	4-19

CF = consult factory representative

**CROSS-REFERENCE (continued)**

Industry Part Number	Motorola Direct Replacement	Motorola Similar Replacement	Page Number
1N6369		1N6386	4-19
1N6370		1N6387	4-19
1N6371		1N6388	4-19
1N6372		1N6389	4-19
1N6373	1N6373		4-19
1N6374	1N6374		4-19
1N6375	1N6375		4-19
1N6376	1N6376		4-19
1N6377	1N6377		4-19
1N6378	1N6378		4-19
1N6379	1N6379		4-19
1N6380	1N6380		4-19
1N6381	1N6381		4-19
1N6382	1N6382		4-19
1N6383	1N6383		4-19
1N6384	1N6384		4-19
1N6385	1N6385		4-19
1N6386	1N6386		4-19
1N6387	1N6387		4-19
1N6388	1N6388		4-19
1N6389	1N6389		4-19
1N6402		P6KE6.8A	4-7
1N6402A		P6KE6.8A	4-7
1N6403		P6KE7.5A	4-7
1N6403A		P6KE7.5A	4-7
1N6404		P6KE7.5A	4-7
1N6404A		P6KE7.5A	4-7
1N6405		P6KE8.2A	4-7
1N6405A		P6KE8.2A	4-7
1N6406		P6KE9.1A	4-7
1N6406A		P6KE9.1A	4-7
1N6407		P6KE10A	4-7
1N6407A		P6KE10A	4-7
1N6408		P6KE10A	4-7
1N6408A		P6KE10A	4-7
1N6409		P6KE11A	4-7
1N6409A		P6KE11A	4-7
1N6410		P6KE12A	4-7
1N6410A		P6KE12A	4-7
1N6411		P6KE13A	4-7
1N6411A		P6KE13A	4-7
1N6412		P6KE15A	4-7
1N6412A		P6KE15A	4-7
1N6413		P6KE15A	4-7
1N6413A		P6KE15A	4-7
1N6414		P6KE18A	4-7
1N6414A		P6KE18A	4-7
1N6415		P6KE18A	4-7
1N6415A		P6KE18A	4-7
1N6416		P6KE20A	4-7

Industry Part Number	Motorola Direct Replacement	Motorola Similar Replacement	Page Number
1N6416A		P6KE20A	4-7
1N6417		P6KE20A	4-7
1N6417A		P6KE20A	4-7
1N6418		P6KE22A	4-7
1N6418A		P6KE22A	4-7
1N6419		P6KE24A	4-7
1N6419A		P6KE24A	4-7
1N6420		P6KE27A	4-7
1N6420A		P6KE27A	4-7
1N6421		P6KE30A	4-7
1N6421A		P6KE30A	4-7
1N6422		P6KE33A	4-7
1N6422A		P6KE33A	4-7
1N6423		P6KE33A	4-7
1N6423A		P6KE33A	4-7
1N6424		P6KE36A	4-7
1N6424A		P6KE36A	4-7
1N6425		P6KE39A	4-7
1N6425A		P6KE39A	4-7
1N6426		P6KE43A	4-7
1N6426A		P6KE43A	4-7
1N6427		P6KE47A	4-7
1N6427A		P6KE47A	4-7
1N6428		P6KE51A	4-7
1N6428A		P6KE51A	4-7
1N6429		P6KE56A	4-7
1N6429A		P6KE56A	4-7
1N6430		P6KE56A	4-7
1N6430A		P6KE56A	4-7
1N6431		P6KE62A	4-7
1N6431A		P6KE62A	4-7
1N6432		P6KE68A	4-7
1N6432A		P6KE68A	4-7
1N6433		P6KE68A	4-7
1N6433A		P6KE68A	4-7
1N6434		P6KE75A	4-7
1N6434A		P6KE75A	4-7
1N6435		P6KE75A	4-7
1N6435A		P6KE75A	4-7
1N6436		P6KE82A	4-7
1N6436A		P6KE82A	4-7
1N6437		P6KE91A	4-7
1N6437A		P6KE91A	4-7
1N6438		P6KE91A	4-7
1N6438A		P6KE91A	4-7
1N6439		P6KE100A	4-7
1N6439A		P6KE100A	4-7
1N6440		P6KE110A	4-7
1N6440A		P6KE110A	4-7
1N6441		P6KE120A	4-7

CF = consult factory representative



**CROSS-REFERENCE (continued)**

Industry Part Number	Motorola Direct Replacement	Motorola Similar Replacement	Page Number
1N6441A		P6KE120A	4-7
1N6442		P6KE130A	4-7
1N6442A		P6KE130A	4-7
1N6443		P6KE150A	4-7
1N6443A		P6KE150A	4-7
1N6444		P6KE160A	4-7
1N6444A		P6KE160A	4-7
1N6445		P6KE180A	4-7
1N6445A		P6KE180A	4-7
1N6446		P6KE200A	4-7
1N6446A		P6KE200A	4-7
1N6447		P6KE200A	4-7
1N6447A		P6KE200A	4-7
1N6448		1.5KE220A	4-17
1N6448A		1.5KE220A	4-17
1N6449		1.5KE250A	4-17
1N6449A		1.5KE250A	4-17
1N6450		1.5KE250A	4-17
1N6450A		1.5KE250A	4-17
1N6461		SA5.0A	4-3
1N6462		SA6.0A	4-3
1N6463		SA12A	4-3
1N6464		SA15A	4-3
1N6465		SA24A	4-3
1N6466		SA30A	4-3
1N6467		SA40A	4-3
1N6468		SA51A	4-3
1N6469		1N6373	4-19
1N6470		1N6268A	4-17
1N6471		1N6384	4-19
1N6472		1N6385	4-19
1N6473		1N6282A	4-17
1N6474		1N6284A	4-17
1N6475		1N6287A	4-17
1N6476		1N6290A	4-17
1N664		1N5237B	6-11
1N665		1N5242B	6-11
1N666		1N5245B	6-11
1N667		1N5248B	6-11
1N668		1N5251B	6-11
1N669		1N5254B	6-11
1N670		1N5266B	6-12
1N671		1N5271B	6-12
1N672		1N5276B	6-12
1N674		1N5230B	6-11
1N675		1N5234B	6-11
1N702		1N5986B	6-13
1N702A		1N5986D	6-13
1N703		1N5989B	6-13
1N703A		1N5989C	6-13

Industry Part Number	Motorola Direct Replacement	Motorola Similar Replacement	Page Number
1N704		1N5990B	6-13
1N704A		1N5990D	6-13
1N705		1N5992B	6-13
1N705A		1N5992D	6-13
1N706		1N5994B	6-13
1N706A		1N5994D	6-13
1N707		1N5996B	6-13
1N707A		1N5996D	6-13
1N708A		1N5232B	6-11
1N709A		1N5234B	6-11
1N710A		1N5235B	6-11
1N711A		1N5236B	6-11
1N712A		1N5237B	6-11
1N713A		1N5239B	6-11
1N714A		1N5240B	6-11
1N715A		1N5241B	6-11
1N716A		1N5242B	6-11
1N717A		1N5243B	6-11
1N718A		1N5245B	6-11
1N719A		1N5246B	6-11
1N720A		1N5248B	6-11
1N721A		1N5250B	6-11
1N722A		1N5251B	6-11
1N723A		1N5252B	6-11
1N724A		1N5254B	6-11
1N725A		1N5256B	6-11
1N726A		1N5257B	6-11
1N727A		1N5258B	6-11
1N728A		1N5259B	6-11
1N729A		1N5260B	6-11
1N730A		1N5261B	6-11
1N731A		1N5262B	6-11
1N732A		1N5263B	6-11
1N733A		1N5265B	6-11
1N734A		1N5266B	6-12
1N735A		1N5267B	6-12
1N736A		1N5268B	6-12
1N737A		1N5270B	6-12
1N738A		1N5271B	6-12
1N739A		1N5272B	6-12
1N740A		1N5273B	6-12
1N741A		1N5274B	6-12
1N742A		1N5276B	6-12
1N743A		1N5277B	6-12
1N744A		1N5279B	6-12
1N745A		1N5281B	6-12
1N746	1N746A		6-8
1N746A	1N746A		6-8
1N746C	1N746C		6-8
1N746D	1N746D		6-8

CF = consult factory representative

**CROSS-REFERENCE (continued)**

Industry Part Number	Motorola Direct Replacement	Motorola Similar Replacement	Page Number
1N747	1N747A		6-8
1N747A	1N747A		6-8
1N747C	1N747C		6-8
1N747D	1N747D		6-8
1N748	1N748A		6-8
1N748A	1N748A		6-8
1N748C	1N748C		6-8
1N748D	1N748D		6-8
1N749	1N749A		6-8
1N749A	1N749A		6-8
1N749C	1N749C		6-8
1N749D	1N749D		6-8
1N750	1N750A		6-8
1N750A	1N750A		6-8
1N750C	1N750C		6-8
1N750D	1N750D		6-8
1N751	1N751A		6-8
1N751A	1N751A		6-8
1N751C	1N751C		6-8
1N751D	1N751D		6-8
1N752	1N752A		6-8
1N752A	1N752A		6-8
1N752C	1N752C		6-8
1N752D	1N752D		6-8
1N753	1N753A		6-8
1N753A	1N753A		6-8
1N753C	1N753C		6-8
1N753D	1N753D		6-8
1N754	1N754A		6-8
1N754A	1N754A		6-8
1N754C	1N754C		6-8
1N754D	1N754D		6-8
1N755	1N755A		6-8
1N755A	1N755A		6-8
1N755C	1N755C		6-8
1N755D	1N755D		6-8
1N756	1N756A		6-8
1N756A	1N756A		6-8
1N756C	1N756C		6-8
1N756D	1N756D		6-8
1N757	1N757A		6-8
1N757A	1N757A		6-8
1N757C	1N757C		6-8
1N757D	1N757D		6-8
1N758	1N758A		6-8
1N758A	1N758A		6-8
1N758C	1N758C		6-8
1N758D	1N758D		6-8
1N759	1N759A		6-8
1N759A	1N759A		6-8

Industry Part Number	Motorola Direct Replacement	Motorola Similar Replacement	Page Number
1N759C	1N759C		6-8
1N759D	1N759D		6-8
1N761		1N5231B	6-11
1N761A		1N5231B	6-11
1N762		1N5233B	6-11
1N762A		1N5233C	6-11
1N763		1N5235B	6-11
1N763A		1N5235D	6-11
1N764		1N5239B	6-11
1N764A		1N5239B	6-11
1N765		1N6001B	6-13
1N765A		1N6001B	6-13
1N766		1N6003B	6-13
1N766A		1N6003B	6-13
1N767		1N6005B	6-13
1N767A		1N6005B	6-13
1N768		1N5249B	6-11
1N768A		1N5249C	6-11
1N769		1N6009B	6-13
1N769A		1N6009B	6-13
1N821	1N821		8-2
1N821A	1N821A		8-2
1N823	1N823		8-2
1N823A	1N823A		8-2
1N825	1N825		8-2
1N825A	1N825A		8-2
1N827	1N827		8-2
1N827A	1N827A		8-2
1N829	1N829		8-2
1N829A	1N829A		8-2
1N957	1N957B		6-8
1N957A	1N957B		6-8
1N957B	1N957B		6-8
1N957C	1N957C		6-8
1N957D	1N957D		6-8
1N958	1N958B		6-8
1N958A	1N958B		6-8
1N958B	1N958B		6-8
1N958C	1N958C		6-8
1N958D	1N958D		6-8
1N959	1N959B		6-8
1N959A	1N959B		6-8
1N959B	1N959B		6-8
1N959C	1N959C		6-8
1N959D	1N959D		6-8
1N960	1N960B		6-8
1N960A	1N960B		6-8
1N960B	1N960B		6-8
1N960C	1N960C		6-8
1N960D	1N960D		6-8

CF = consult factory representative

**CROSS-REFERENCE (continued)**

Industry Part Number	Motorola Direct Replacement	Motorola Similar Replacement	Page Number
1N961	1N961B		6-8
1N961A	1N961B		6-8
1N961B	1N961B		6-8
1N961C	1N961C		6-8
1N961D	1N961D		6-8
1N962	1N962B		6-8
1N962A	1N962B		6-8
1N962B	1N962B		6-8
1N962C	1N962C		6-8
1N962D	1N962D		6-8
1N963	1N963B		6-8
1N963A	1N963B		6-8
1N963B	1N963B		6-8
1N963C	1N963C		6-8
1N963D	1N963D		6-8
1N964	1N964B		6-8
1N964A	1N964B		6-8
1N964B	1N964B		6-8
1N964C	1N964C		6-8
1N964D	1N964D		6-8
1N965	1N965B		6-8
1N965A	1N965B		6-8
1N965B	1N965B		6-8
1N965C	1N965C		6-8
1N965D	1N965D		6-8
1N966	1N966B		6-8
1N966A	1N966B		6-8
1N966B	1N966B		6-8
1N966C	1N966C		6-8
1N966D	1N966D		6-8
1N967	1N967B		6-8
1N967A	1N967B		6-8
1N967B	1N967B		6-8
1N967C	1N967C		6-8
1N967D	1N967D		6-8
1N968	1N968B		6-8
1N968A	1N968B		6-8
1N968B	1N968B		6-8
1N968C	1N968C		6-8
1N968D	1N968D		6-8
1N969	1N969B		6-8
1N969A	1N969B		6-8
1N969B	1N969B		6-8
1N969C	1N969C		6-8
1N969D	1N969D		6-8
1N970	1N970B		6-8
1N970A	1N970B		6-8
1N970B	1N970B		6-8
1N970C	1N970C		6-8
1N970D	1N970D		6-8

Industry Part Number	Motorola Direct Replacement	Motorola Similar Replacement	Page Number
1N971	1N971B		6-8
1N971A	1N971B		6-8
1N971B	1N971B		6-8
1N971C	1N971C		6-8
1N971D	1N971D		6-8
1N972	1N972B		6-8
1N972A	1N972B		6-8
1N972B	1N972B		6-8
1N972C	1N972C		6-8
1N972D	1N972D		6-8
1N973	1N973B		6-8
1N973A	1N973B		6-8
1N973B	1N973B		6-8
1N973C	1N973C		6-8
1N973D	1N973D		6-8
1N974	1N974B		6-8
1N974A	1N974B		6-8
1N974B	1N974B		6-8
1N974C	1N974C		6-8
1N974D	1N974D		6-8
1N975	1N975B		6-8
1N975A	1N975B		6-8
1N975B	1N975B		6-8
1N975C	1N975C		6-8
1N975D	1N975D		6-8
1N976	1N976B		6-8
1N976A	1N976B		6-8
1N976B	1N976B		6-8
1N976C	1N976C		6-8
1N976D	1N976D		6-8
1N977	1N977B		6-8
1N977A	1N977B		6-8
1N977B	1N977B		6-8
1N977C	1N977C		6-8
1N977D	1N977D		6-8
1N978	1N978B		6-8
1N978A	1N978B		6-8
1N978B	1N978B		6-8
1N978C	1N978C		6-8
1N978D	1N978D		6-8
1N979	1N979B		6-8
1N979A	1N979B		6-8
1N979B	1N979B		6-8
1N979C	1N979C		6-8
1N979D	1N979D		6-8
1N980	1N980B		6-8
1N980A	1N980B		6-8
1N980B	1N980B		6-8
1N980C	1N980C		6-8
1N980D	1N980D		6-8

CF = consult factory representative

**CROSS-REFERENCE (continued)**

Industry Part Number	Motorola Direct Replacement	Motorola Similar Replacement	Page Number
1N981	1N981B		6-9
1N981A	1N981B		6-9
1N981B	1N981B		6-9
1N981C	1N981C		6-9
1N981D	1N981D		6-9
1N982	1N982B		6-9
1N982A	1N982B		6-9
1N982B	1N982B		6-9
1N982C	1N982C		6-9
1N982D	1N982D		6-9
1N983	1N983B		6-9
1N983A	1N983B		6-9
1N983B	1N983B		6-9
1N983C	1N983C		6-9
1N983D	1N983D		6-9
1N984	1N984B		6-9
1N984A	1N984B		6-9
1N984B	1N984B		6-9
1N984C	1N984C		6-9
1N984D	1N984D		6-9
1N985	1N985B		6-9
1N985A	1N985B		6-9
1N985B	1N985B		6-9
1N985C	1N985C		6-9
1N985D	1N985D		6-9
1N986	1N986B		6-9
1N986A	1N986B		6-9
1N986B	1N986B		6-9
1N986C	1N986C		6-9
1N986D	1N986D		6-9
1N987	1N987B		6-9
1N987A	1N987B		6-9
1N987B	1N987B		6-9
1N987C	1N987C		6-9
1N987D	1N987D		6-9
1N988	1N988B		6-9
1N988A	1N988B		6-9
1N988B	1N988B		6-9
1N988C	1N988C		6-9
1N988D	1N988D		6-9
1N989	1N989B		6-9
1N989A	1N989B		6-9
1N989B	1N989B		6-9
1N989C	1N989C		6-9
1N989D	1N989D		6-9
1N990	1N990B		6-9
1N990A	1N990B		6-9
1N990B	1N990B		6-9
1N990C	1N990C		6-9
1N990D	1N990D		6-9

Industry Part Number	Motorola Direct Replacement	Motorola Similar Replacement	Page Number
1N991	1N991B		6-9
1N991A	1N991B		6-9
1N991B	1N991B		6-9
1N991C	1N991C		6-9
1N991D	1N991D		6-9
1N992	1N992B		6-9
1N992A	1N992B		6-9
1N992B	1N992B		6-9
1N992C	1N992C		6-9
1N992D	1N992D		6-9
1SMB100AT3	1SMB100AT3		5-14
1SMB10AT3	1SMB10AT3		5-14
1SMB110AT3	1SMB110AT3		5-14
1SMB11AT3	1SMB11AT3		5-14
1SMB120AT3	1SMB120AT3		5-14
1SMB12AT3	1SMB12AT3		5-14
1SMB130AT3	1SMB130AT3		5-14
1SMB13AT3	1SMB13AT3		5-14
1SMB14AT3	1SMB14AT3		5-14
1SMB150AT3	1SMB150AT3		5-14
1SMB15AT3	1SMB15AT3		5-14
1SMB160AT3	1SMB160AT3		5-14
1SMB16AT3	1SMB16AT3		5-14
1SMB170AT3	1SMB170AT3		5-14
1SMB17AT3	1SMB17AT3		5-14
1SMB18AT3	1SMB18AT3		5-14
1SMB20AT3	1SMB20AT3		5-14
1SMB22AT3	1SMB22AT3		5-14
1SMB24AT3	1SMB24AT3		5-14
1SMB26AT3	1SMB26AT3		5-14
1SMB28AT3	1SMB28AT3		5-14
1SMB30AT3	1SMB30AT3		5-14
1SMB33AT3	1SMB33AT3		5-14
1SMB36AT3	1SMB36AT3		5-14
1SMB40AT3	1SMB40AT3		5-14
1SMB43AT3	1SMB43AT3		5-14
1SMB45AT3	1SMB45AT3		5-14
1SMB48AT3	1SMB48AT3		5-14
1SMB5.0AT3	1SMB5.0AT3		5-14
1SMB51AT3	1SMB51AT3		5-14
1SMB54AT3	1SMB54AT3		5-14
1SMB58AT3	1SMB58AT3		5-14
1SMB5913BT3	1SMB5913BT3		7-17
1SMB5914BT3	1SMB5914BT3		7-17
1SMB5915BT3	1SMB5915BT3		7-17
1SMB5916BT3	1SMB5916BT3		7-17
1SMB5917BT3	1SMB5917BT3		7-17
1SMB5918BT3	1SMB5918BT3		7-17
1SMB5919BT3	1SMB5919BT3		7-17
1SMB5920BT3	1SMB5920BT3		7-17

CF = consult factory representative

**CROSS-REFERENCE (continued)**

Industry Part Number	Motorola Direct Replacement	Motorola Similar Replacement	Page Number
1SMB5921BT3	1SMB5921BT3		7-17
1SMB5922BT3	1SMB5922BT3		7-17
1SMB5923BT3	1SMB5923BT3		7-17
1SMB5924BT3	1SMB5924BT3		7-17
1SMB5925BT3	1SMB5925BT3		7-17
1SMB5926BT3	1SMB5926BT3		7-17
1SMB5927BT3	1SMB5927BT3		7-17
1SMB5928BT3	1SMB5928BT3		7-17
1SMB5929BT3	1SMB5929BT3		7-18
1SMB5930BT3	1SMB5930BT3		7-18
1SMB5931BT3	1SMB5931BT3		7-18
1SMB5932BT3	1SMB5932BT3		7-18
1SMB5933BT3	1SMB5933BT3		7-18
1SMB5934BT3	1SMB5934BT3		7-18
1SMB5935BT3	1SMB5935BT3		7-18
1SMB5936BT3	1SMB5936BT3		7-18
1SMB5937BT3	1SMB5937BT3		7-18
1SMB5938BT3	1SMB5938BT3		7-18
1SMB5939BT3	1SMB5939BT3		7-18
1SMB5940BT3	1SMB5940BT3		7-18
1SMB5941BT3	1SMB5941BT3		7-18
1SMB5942BT3	1SMB5942BT3		7-18
1SMB5943BT3	1SMB5943BT3		7-18
1SMB5944BT3	1SMB5944BT3		7-18
1SMB5945BT3	1SMB5945BT3		7-18
1SMB5946BT3	1SMB5946BT3		7-18
1SMB5947BT3	1SMB5947BT3		7-18
1SMB5948BT3	1SMB5948BT3		7-18
1SMB5949BT3	1SMB5949BT3		7-18
1SMB5950BT3	1SMB5950BT3		7-18
1SMB5951BT3	1SMB5951BT3		7-18
1SMB5952BT3	1SMB5952BT3		7-18
1SMB5953BT3	1SMB5953BT3		7-18
1SMB5954BT3	1SMB5954BT3		7-18
1SMB5955BT3	1SMB5955BT3		7-18
1SMB5956BT3	1SMB5956BT3		7-18
1SMB6.0AT3	1SMB6.0AT3		5-14
1SMB6.5AT3	1SMB6.5AT3		5-14
1SMB60AT3	1SMB60AT3		5-14
1SMB64AT3	1SMB64AT3		5-14
1SMB7.0AT3	1SMB7.0AT3		5-14
1SMB7.5AT3	1SMB7.5AT3		5-14
1SMB70AT3	1SMB70AT3		5-14
1SMB75AT3	1SMB75AT3		5-14
1SMB78AT3	1SMB78AT3		5-14
1SMB8.0AT3	1SMB8.0AT3		5-14
1SMB8.5AT3	1SMB8.5AT3		5-14
1SMB85AT3	1SMB85AT3		5-14
1SMB9.0AT3	1SMB9.0AT3		5-14
1SMB90AT3	1SMB90AT3		5-14

Industry Part Number	Motorola Direct Replacement	Motorola Similar Replacement	Page Number
1SMC10AT3	1SMC10AT3		5-22
1SMC11AT3	1SMC11AT3		5-22
1SMC12AT3	1SMC12AT3		5-22
1SMC13AT3	1SMC13AT3		5-22
1SMC14AT3	1SMC14AT3		5-22
1SMC15AT3	1SMC15AT3		5-22
1SMC16AT3	1SMC16AT3		5-22
1SMC17AT3	1SMC17AT3		5-22
1SMC18AT3	1SMC18AT3		5-22
1SMC20AT3	1SMC20AT3		5-22
1SMC22AT3	1SMC22AT3		5-22
1SMC24AT3	1SMC24AT3		5-22
1SMC26AT3	1SMC26AT3		5-22
1SMC28AT3	1SMC28AT3		5-22
1SMC30AT3	1SMC30AT3		5-22
1SMC33AT3	1SMC33AT3		5-22
1SMC36AT3	1SMC36AT3		5-22
1SMC40AT3	1SMC40AT3		5-22
1SMC43AT3	1SMC43AT3		5-22
1SMC45AT3	1SMC45AT3		5-22
1SMC48AT3	1SMC48AT3		5-22
1SMC5.0AT3	1SMC5.0AT3		5-22
1SMC51AT3	1SMC51AT3		5-22
1SMC54AT3	1SMC54AT3		5-22
1SMC58AT3	1SMC58AT3		5-22
1SMC6.0AT3	1SMC6.0AT3		5-22
1SMC6.5AT3	1SMC6.5AT3		5-22
1SMC60AT3	1SMC60AT3		5-22
1SMC64AT3	1SMC64AT3		5-22
1SMC7.0AT3	1SMC7.0AT3		5-22
1SMC7.5AT3	1SMC7.5AT3		5-22
1SMC70AT3	1SMC70AT3		5-22
1SMC75AT3	1SMC75AT3		5-22
1SMC78AT3	1SMC78AT3		5-22
1SMC8.0AT3	1SMC8.0AT3		5-22
1SMC8.5AT3	1SMC8.5AT3		5-22
1SMC9.0AT3	1SMC9.0AT3		5-22
3EZ100D5	3EZ100D5		6-33
3EZ10D5	3EZ10D5		6-33
3EZ110D5	3EZ110D5		6-33
3EZ11D5	3EZ11D5		6-33
3EZ120D5	3EZ120D5		6-33
3EZ12D5	3EZ12D5		6-33
3EZ130D5	3EZ130D5		6-33
3EZ13D5	3EZ13D5		6-33
3EZ140D5	3EZ140D5		6-33
3EZ14D5	3EZ14D5		6-33
3EZ150D5	3EZ150D5		6-33
3EZ15D5	3EZ15D5		6-33
3EZ160D5	3EZ160D5		6-33

CF = consult factory representative

**CROSS-REFERENCE (continued)**

Industry Part Number	Motorola Direct Replacement	Motorola Similar Replacement	Page Number
3EZ16D5	3EZ16D5		6-33
3EZ170D5	3EZ170D5		6-33
3EZ17D5	3EZ17D5		6-33
3EZ180D5	3EZ180D5		6-33
3EZ18D5	3EZ18D5		6-33
3EZ190D5	3EZ190D5		6-33
3EZ19D5	3EZ19D5		6-33
3EZ200D5	3EZ200D5		6-33
3EZ20D5	3EZ20D5		6-33
3EZ220D5	3EZ220D5		6-33
3EZ22D5	3EZ22D5		6-33
3EZ240D5	3EZ240D5		6-33
3EZ24D5	3EZ24D5		6-33
3EZ270D5	3EZ270D5		6-33
3EZ27D5	3EZ27D5		6-33
3EZ28D5	3EZ28D5		6-33
3EZ3.9D5	3EZ3.9D5		6-33
3EZ300D5	3EZ300D5		6-33
3EZ30D5	3EZ30D5		6-33
3EZ330D5	3EZ330D5		6-33
3EZ33D5	3EZ33D5		6-33
3EZ360D5	3EZ360D5		6-33
3EZ36D5	3EZ36D5		6-33
3EZ39D5	3EZ39D5		6-33
3EZ4.3D5	3EZ4.3D5		6-33
3EZ4.7D5	3EZ4.7D5		6-33
3EZ400D5	3EZ400D5		6-33
3EZ43D5	3EZ43D5		6-33
3EZ47D5	3EZ47D5		6-33
3EZ5.1D5	3EZ5.1D5		6-33
3EZ5.6D5	3EZ5.6D5		6-33
3EZ51D5	3EZ51D5		6-33
3EZ56D5	3EZ56D5		6-33
3EZ6.2D5	3EZ6.2D5		6-33
3EZ6.8D5	3EZ6.8D5		6-33
3EZ62D5	3EZ62D5		6-33
3EZ68D5	3EZ68D5		6-33
3EZ7.5D5	3EZ7.5D5		6-33
3EZ75D5	3EZ75D5		6-33
3EZ8.2D5	3EZ8.2D5		6-33
3EZ82D5	3EZ82D5		6-33
3EZ9.1D5	3EZ9.1D5		6-33
3EZ91D5	3EZ91D5		6-33
BZV55C10		MMSZ10T1	7-14
BZV55C11		MMSZ11T1	7-14
BZV55C12		MMSZ12T1	7-14
BZV55C13		MMSZ13T1	7-14
BZV55C15		MMSZ15T1	7-14
BZV55C16		MMSZ16T1	7-14
BZV55C18		MMSZ18T1	7-14

Industry Part Number	Motorola Direct Replacement	Motorola Similar Replacement	Page Number
BZV55C20		MMSZ20T1	7-14
BZV55C22		MMSZ22T1	7-14
BZV55C24		MMSZ24T1	7-14
BZV55C27		MMSZ27T1	7-14
BZV55C2V4		MMSZ2V4T1	7-14
BZV55C2V7		MMSZ2V7T1	7-14
BZV55C30		MMSZ30T1	7-14
BZV55C33		MMSZ33T1	7-14
BZV55C36		MMSZ36T1	7-14
BZV55C39		MMSZ39T1	7-14
BZV55C3V0		MMSZ3V0T1	7-14
BZV55C3V3		MMSZ3V3T1	7-14
BZV55C3V6		MMSZ3V6T1	7-14
BZV55C3V9		MMSZ3V9T1	7-14
BZV55C43		MMSZ43T1	7-14
BZV55C47		MMSZ47T1	7-14
BZV55C4V3		MMSZ4V3T1	7-14
BZV55C4V7		MMSZ4V7T1	7-14
BZV55C51		MMSZ51T1	7-14
BZV55C56		MMSZ56T1	7-14
BZV55C5V1		MMSZ5V1T1	7-14
BZV55C5V6		MMSZ5V6T1	7-14
BZV55C6V2		MMSZ6V2T1	7-14
BZV55C6V8		MMSZ6V8T1	7-14
BZV55C7V5		MMSZ7V5T1	7-14
BZV55C8V2		MMSZ8V2T1	7-14
BZV55C9V1		MMSZ9V1T1	7-14
BZW04-10		SA10A	4-3
BZW04-102		SA100A	4-3
BZW04-102B		SA100CA	4-3
BZW04-10B		SA10CA	4-3
BZW04-11		SA11A	4-3
BZW04-111		SA110A	4-3
BZW04-111B		SA110CA	4-3
BZW04-11B		SA11CA	4-3
BZW04-128		SA130A	4-3
BZW04-128B		SA130CA	4-3
BZW04-13		SA13A	4-3
BZW04-136		SA150A	4-3
BZW04-136B		SA150CA	4-3
BZW04-13B		SA13CA	4-3
BZW04-14		SA14A	4-3
BZW04-145		SA150A	4-3
BZW04-145B		SA150CA	4-3
BZW04-14B		SA14CA	4-3
BZW04-15		SA16A	4-3
BZW04-154		SA160A	4-3
BZW04-154B		SA160CA	4-3
BZW04-15B		SA16CA	4-3
BZW04-17		SA17A	4-3

CF = consult factory representative

**CROSS-REFERENCE (continued)**

Industry Part Number	Motorola Direct Replacement	Motorola Similar Replacement	Page Number
BZW04-171		SA170A	4-3
BZW04-171B		SA170CA	4-3
BZW04-17B		SA17CA	4-3
BZW04-19		SA20	4-3
BZW04-19B		SA20	4-3
BZW04-20		SA22A	4-3
BZW04-20B		SA22CA	4-3
BZW04-23		SA24A	4-3
BZW04-23B		SA24CA	4-3
BZW04-26		SA26A	4-3
BZW04-26B		SA26CA	4-3
BZW04-28		SA28A	4-3
BZW04-28B		SA28CA	4-3
BZW04-31		SA33A	4-3
BZW04-31B		SA33CA	4-3
BZW04-33		SA33A	4-3
BZW04-33B		SA33CA	4-3
BZW04-37		SA40A	4-3
BZW04-37B		SA40CA	4-3
BZW04-40		SA40A	4-3
BZW04-40B		SA40CA	4-3
BZW04-44		SA45A	4-3
BZW04-44B		SA45CA	4-3
BZW04-48		SA48A	4-3
BZW04-48B		SA48CA	4-3
BZW04-53		SA54A	4-3
BZW04-53B		SA54CA	4-3
BZW04-58		SA58A	4-3
BZW04-58B		SA58CA	4-3
BZW04-5V8		SA6.0A	4-3
BZW04-5V8B		SA6.0CA	4-3
BZW04-64		SA64A	4-3
BZW04-64B		SA64CA	4-3
BZW04-6V4		SA6.5A	4-3
BZW04-6V4B		SA6.5CA	4-3
BZW04-70		SA70A	4-3
BZW04-70B		SA70CA	4-3
BZW04-78		SA78A	4-3
BZW04-78B		SA78CA	4-3
BZW04-7V0		SA7.0A	4-3
BZW04-7V0B		SA7.0CA	4-3
BZW04-7V8		SA8.0A	4-3
BZW04-7V8B		SA8.0CA	4-3
BZW04-85		SA85A	4-3
BZW04-85B		SA85CA	4-3
BZW04-8V5		SA8.5A	4-3
BZW04-8V5B		SA8.5CA	4-3
BZW04-94		SA100A	4-3
BZW04-94B		SA100CA	4-3
BZW04-9V4		SA10A	4-3

Industry Part Number	Motorola Direct Replacement	Motorola Similar Replacement	Page Number
BZW04-9V4B		SA10CA	4-3
BZW04P10		SA10A	4-3
BZW04P102		SA100A	4-3
BZW04P102B		SA100CA	4-3
BZW04P10B		SA10CA	4-3
BZW04P11		SA11A	4-3
BZW04P111		SA110A	4-3
BZW04P111B		SA110CA	4-3
BZW04P11B		SA11CA	4-3
BZW04P128		SA130A	4-3
BZW04P128B		SA130CA	4-3
BZW04P13		SA13A	4-3
BZW04P136		SA150A	4-3
BZW04P136B		SA150CA	4-3
BZW04P13B		SA13CA	4-3
BZW04P14		SA14A	4-3
BZW04P145		SA150A	4-3
BZW04P145B		SA150CA	4-3
BZW04P14B		SA14CA	4-3
BZW04P15		SA16A	4-3
BZW04P154		SA160A	4-3
BZW04P154B		SA160CA	4-3
BZW04P15B		SA16CA	4-3
BZW04P17		SA17A	4-3
BZW04P171		SA170A	4-3
BZW04P171B		SA170CA	4-3
BZW04P17B		SA17CA	4-3
BZW04P19		SA20A	4-3
BZW04P19B		SA20CA	4-3
BZW04P20		SA22A	4-3
BZW04P20B		SA22CA	4-3
BZW04P23		SA24A	4-3
BZW04P23B		SA24CA	4-3
BZW04P26		SA26A	4-3
BZW04P26B		SA26CA	4-3
BZW04P28		SA28A	4-3
BZW04P28B		SA28CA	4-3
BZW04P31		SA33A	4-3
BZW04P31B		SA33CA	4-3
BZW04P33		SA33A	4-3
BZW04P33B		SA33CA	4-3
BZW04P37		SA40A	4-3
BZW04P37B		SA40CA	4-3
BZW04P40		SA40A	4-3
BZW04P40B		SA40CA	4-3
BZW04P44		SA45A	4-3
BZW04P44B		SA45CA	4-3
BZW04P48		SA48A	4-3
BZW04P48B		SA48CA	4-3
BZW04P53		SA54A	4-3

CF = consult factory representative

**CROSS-REFERENCE (continued)**

Industry Part Number	Motorola Direct Replacement	Motorola Similar Replacement	Page Number
BZW04P53B		SA54CA	4-3
BZW04P58		SA58A	4-3
BZW04P58B		SA58CA	4-3
BZW04P5V8		SA6.0A	4-3
BZW04P5V8B		SA6.0CA	4-3
BZW04P64		SA64A	4-3
BZW04P64B		SA64CA	4-3
BZW04P6V4		SA6.5A	4-3
BZW04P6V4B		SA6.5CA	4-3
BZW04P70		SA70A	4-3
BZW04P70B		SA70CA	4-3
BZW04P78		SA78A	4-3
BZW04P78B		SA78CA	4-3
BZW04P7V0		SA7.0A	4-3
BZW04P7V0B		SA7.0CA	4-3
BZW04P7V8		SA8.0A	4-3
BZW04P7V8B		SA8.0CA	4-3
BZW04P85		SA85A	4-3
BZW04P85B		SA85CA	4-3
BZW04P8V5		SA8.5A	4-3
BZW04P8V5B		SA8.5CA	4-3
BZW04P94		SA100A	4-3
BZW04P94B		SA100CA	4-3
BZW04P9V4		SA10A	4-3
BZW04P9V4B		SA10CA	4-3
BZW06-10		P6KE12A	4-7
BZW06-102		P6KE120A	4-7
BZW06-102B		P6KE120CA	4-7
BZW06-10B		P6KE12CA	4-7
BZW06-11		P6KE13A	4-7
BZW06-111		P6KE130A	4-7
BZW06-111B		P6KE130CA	4-7
BZW06-11B		P6KE13CA	4-7
BZW06-128		P6KE150A	4-7
BZW06-128B		P6KE150CA	4-7
BZW06-13		P6KE15A	4-7
BZW06-136		P6KE160A	4-7
BZW06-136B		P6KE160CA	4-7
BZW06-13B		P6KE15CA	4-7
BZW06-14		P6KE16A	4-7
BZW06-145		P6KE170A	4-7
BZW06-145B		P6KE170CA	4-7
BZW06-14B		P6KE16CA	4-7
BZW06-15		P6KE18A	4-7
BZW06-154		P6KE180A	4-7
BZW06-154B		P6KE180CA	4-7
BZW06-15B		P6KE18CA	4-7
BZW06-17		P6KE20A	4-7
BZW06-171		P6KE200A	4-7
BZW06-171B		P6KE200CA	4-7

Industry Part Number	Motorola Direct Replacement	Motorola Similar Replacement	Page Number
BZW06-17B		P6KE20CA	4-7
BZW06-188		1.5KE220A	4-17
BZW06-188B		1.5KE220CA	4-17
BZW06-19		P6KE22A	4-7
BZW06-19B		P6KE22CA	4-7
BZW06-20		P6KE24A	4-7
BZW06-20B		P6KE24CA	4-7
BZW06-213		1.5KE250A	4-17
BZW06-213B		1.5KE250CA	4-17
BZW06-23		P6KE27A	4-7
BZW06-23B		P6KE27CA	4-7
BZW06-26		P6KE30A	4-7
BZW06-26B		P6KE30CA	4-7
BZW06-28		P6KE33A	4-7
BZW06-28B		P6KE33CA	4-7
BZW06-31		P6KE36A	4-7
BZW06-31B		P6KE36CA	4-7
BZW06-33		P6KE39A	4-7
BZW06-33B		P6KE39CA	4-7
BZW06-37		P6KE43A	4-7
BZW06-37B		P6KE43CA	4-7
BZW06-40		P6KE47A	4-7
BZW06-40B		P6KE47CA	4-7
BZW06-44		P6KE51A	4-7
BZW06-44B		P6KE51CA	4-7
BZW06-48		P6KE56A	4-7
BZW06-48B		P6KE56CA	4-7
BZW06-53		P6KE62A	4-7
BZW06-53B		P6KE62CA	4-7
BZW06-58		P6KE68A	4-7
BZW06-58B		P6KE68CA	4-7
BZW06-5V8		P6KE6.8A	4-7
BZW06-5V8B		P6KE6.8CA	4-7
BZW06-64		P6KE75A	4-7
BZW06-64B		P6KE75CA	4-7
BZW06-6V4		P6KE7.5A	4-7
BZW06-6V4B		P6KE7.5CA	4-7
BZW06-70		P6KE82A	4-7
BZW06-70B		P6KE82CA	4-7
BZW06-78		P6KE91A	4-7
BZW06-78B		P6KE91CA	4-7
BZW06-7V0		P6KE8.2A	4-7
BZW06-7V0B		P6KE8.2CA	4-7
BZW06-7V8		P6KE9.1A	4-7
BZW06-7V8B		P6KE9.1CA	4-7
BZW06-85		P6KE100A	4-7
BZW06-85B		P6KE100CA	4-7
BZW06-8V5		P6KE10A	4-7
BZW06-8V5B		P6KE10CA	4-7
BZW06-94		P6KE110A	4-7

CF = consult factory representative



**CROSS-REFERENCE (continued)**

Industry Part Number	Motorola Direct Replacement	Motorola Similar Replacement	Page Number
BZW06-94B		P6KE110CA	4-7
BZW06-9V4		P6KE11A	4-7
BZW06-9V4B		P6KE11CA	4-7
BZW06P10		P6KE12A	4-7
BZW06P102		P6KE120A	4-7
BZW06P102B		P6KE120CA	4-7
BZW06P10B		P6KE12CA	4-7
BZW06P11		P6KE13A	4-7
BZW06P111		P6KE130A	4-7
BZW06P111B		P6KE130CA	4-7
BZW06P11B		P6KE13CA	4-7
BZW06P128		P6KE150A	4-7
BZW06P128B		P6KE150CA	4-7
BZW06P13		P6KE15A	4-7
BZW06P136		P6KE160A	4-7
BZW06P136B		P6KE160CA	4-7
BZW06P13B		P6KE15CA	4-7
BZW06P14		P6KE16A	4-7
BZW06P145		P6KE170A	4-7
BZW06P145B		P6KE170CA	4-7
BZW06P14B		P6KE16CA	4-7
BZW06P15		P6KE18A	4-7
BZW06P154		P6KE180A	4-7
BZW06P154B		P6KE180CA	4-7
BZW06P15B		P6KE18CA	4-7
BZW06P17		P6KE20A	4-7
BZW06P171		P6KE200A	4-7
BZW06P171B		P6KE200CA	4-7
BZW06P17B		P6KE20CA	4-7
BZW06P188		1.5KE220A	4-17
BZW06P188B		1.5KE220CA	4-17
BZW06P19		P6KE22A	4-7
BZW06P19B		P6KE22CA	4-7
BZW06P20		P6KE24A	4-7
BZW06P20B		P6KE24CA	4-7
BZW06P213		1.5KE250A	4-17
BZW06P213B		1.5KE250CA	4-17
BZW06P23		P6KE27A	4-7
BZW06P23B		P6KE27CA	4-7
BZW06P26		P6KE30A	4-7
BZW06P26B		P6KE30CA	4-7
BZW06P28		P6KE33A	4-7
BZW06P28B		P6KE33CA	4-7
BZW06P31		P6KE36A	4-7
BZW06P31B		P6KE36CA	4-7
BZW06P33		P6KE39A	4-7
BZW06P33B		P6KE39CA	4-7
BZW06P37		P6KE43A	4-7
BZW06P37B		P6KE43CA	4-7
BZW06P40		P6KE47A	4-7

Industry Part Number	Motorola Direct Replacement	Motorola Similar Replacement	Page Number
BZW06P40B		P6KE47CA	4-7
BZW06P44		P6KE51A	4-7
BZW06P44B		P6KE51CA	4-7
BZW06P48		P6KE56A	4-7
BZW06P48B		P6KE56CA	4-7
BZW06P53		P6KE62A	4-7
BZW06P53B		P6KE62CA	4-7
BZW06P58		P6KE68A	4-7
BZW06P58B		P6KE68CA	4-7
BZW06P5V8		P6KE6.8A	4-7
BZW06P5V8B		P6KE6.8CA	4-7
BZW06P64		P6KE75A	4-7
BZW06P64B		P6KE75CA	4-7
BZW06P6V4		P6KE7.5A	4-7
BZW06P6V4B		P6KE7.5CA	4-7
BZW06P70		P6KE82A	4-7
BZW06P70B		P6KE82CA	4-7
BZW06P78		P6KE91A	4-7
BZW06P78B		P6KE91CA	4-7
BZW06P7V0		P6KE8.2A	4-7
BZW06P7V0B		P6KE8.2CA	4-7
BZW06P7V8		P6KE9.1A	4-7
BZW06P7V8B		P6KE9.1CA	4-7
BZW06P85		P6KE100A	4-7
BZW06P85B		P6KE100CA	4-7
BZW06P8V5		P6KE10A	4-7
BZW06P8V5B		P6KE10CA	4-7
BZW06P94		P6KE110A	4-7
BZW06P94B		P6KE110CA	4-7
BZW06P9V4		P6KE11A	4-7
BZW06P9V4B		P6KE11CA	4-7
BZW07-10		1N6276A	4-17
BZW07-10B		1.5KE16CA	4-17
BZW07-110		1N6300A	4-17
BZW07-110B		1.5KE160CA	4-17
BZW07-27		1N6284A	4-17
BZW07-27B		1.5KE36CA	4-17
BZW07-43		1N6290A	4-17
BZW07-43B		1.5KE62CA	4-17
BZW11-10		1N6276A	4-17
BZW11-10B		1.5KE16CA	4-17
BZW11-110		1N6300A	4-17
BZW11-110B		1.5KE160CA	4-17
BZW11-27		1N6284A	4-17
BZW11-27B		1.5KE36CA	4-17
BZW11-43		1N6290A	4-17
BZW11-43B		1.5KE62CA	4-17
BZX55C10	BZX55C10RL		6-14
BZX55C11	BZX55C11RL		6-14
BZX55C12	BZX55C12RL		6-14

CF = consult factory representative

**CROSS-REFERENCE (continued)**

Industry Part Number	Motorola Direct Replacement	Motorola Similar Replacement	Page Number
BZX55C13	BZX55C13RL		6-14
BZX55C15	BZX55C15RL		6-14
BZX55C16	BZX55C16RL		6-14
BZX55C18	BZX55C18RL		6-14
BZX55C20	BZX55C20RL		6-14
BZX55C22	BZX55C22RL		6-14
BZX55C24	BZX55C24RL		6-14
BZX55C27	BZX55C27RL		6-14
BZX55C2V4	BZX55C2V4RL		6-14
BZX55C2V7	BZX55C2V7RL		6-14
BZX55C30	BZX55C30RL		6-14
BZX55C33	BZX55C33RL		6-14
BZX55C36	BZX55C36RL		6-14
BZX55C39	BZX55C39RL		6-14
BZX55C3V0	BZX55C3V0RL		6-14
BZX55C3V3	BZX55C3V3RL		6-14
BZX55C3V6	BZX55C3V6RL		6-14
BZX55C3V9	BZX55C3V9RL		6-14
BZX55C43	BZX55C43RL		6-14
BZX55C47	BZX55C47RL		6-14
BZX55C4V3	BZX55C4V3RL		6-14
BZX55C4V7	BZX55C4V7RL		6-14
BZX55C51	BZX55C51RL		6-14
BZX55C56	BZX55C56RL		6-14
BZX55C5V1	BZX55C5V1RL		6-14
BZX55C5V6	BZX55C5V6RL		6-14
BZX55C62	BZX55C62RL		6-14
BZX55C68	BZX55C68RL		6-14
BZX55C6V2	BZX55C6V2RL		6-14
BZX55C6V8	BZX55C6V8RL		6-14
BZX55C75	BZX55C75RL		6-14
BZX55C7V5	BZX55C7V5RL		6-14
BZX55C82	BZX55C82RL		6-14
BZX55C8V2	BZX55C8V2RL		6-14
BZX55C91	BZX55C91RL		6-14
BZX55C9V1	BZX55C9V1RL		6-14
BZX79C10	BZX79C10RL		6-15
BZX79C100	BZX79C100RL		6-15
BZX79C11	BZX79C11RL		6-15
BZX79C110	BZX79C110RL		6-15
BZX79C12	BZX79C12RL		6-15
BZX79C120	BZX79C120RL		6-15
BZX79C13	BZX79C13RL		6-15
BZX79C130	BZX79C130RL		6-15
BZX79C15	BZX79C15RL		6-15
BZX79C150	BZX79C150RL		6-15
BZX79C16	BZX79C16RL		6-15
BZX79C160	BZX79C160RL		6-15
BZX79C18	BZX79C18RL		6-15
BZX79C180	BZX79C180RL		6-15

Industry Part Number	Motorola Direct Replacement	Motorola Similar Replacement	Page Number
BZX79C20	BZX79C20RL		6-15
BZX79C200	BZX79C200RL		6-15
BZX79C22	BZX79C22RL		6-15
BZX79C24	BZX79C24RL		6-15
BZX79C27	BZX79C27RL		6-15
BZX79C2V4	BZX79C2V4RL		6-15
BZX79C2V7	BZX79C2V7RL		6-15
BZX79C30	BZX79C30RL		6-15
BZX79C33	BZX79C33RL		6-15
BZX79C36	BZX79C36RL		6-15
BZX79C39	BZX79C39RL		6-15
BZX79C3V0	BZX79C3V0RL		6-15
BZX79C3V3	BZX79C3V3RL		6-15
BZX79C3V6	BZX79C3V6RL		6-15
BZX79C3V9	BZX79C3V9RL		6-15
BZX79C43	BZX79C43RL		6-15
BZX79C47	BZX79C47RL		6-15
BZX79C4V3	BZX79C4V3RL		6-15
BZX79C4V7	BZX79C4V7RL		6-15
BZX79C51	BZX79C51RL		6-15
BZX79C56	BZX79C56RL		6-15
BZX79C5V1	BZX79C5V1RL		6-15
BZX79C5V6	BZX79C5V6RL		6-15
BZX79C62	BZX79C62RL		6-15
BZX79C68	BZX79C68RL		6-15
BZX79C6V2	BZX79C6V2RL		6-15
BZX79C6V8	BZX79C6V8RL		6-15
BZX79C75	BZX79C75RL		6-15
BZX79C7V5	BZX79C7V5RL		6-15
BZX79C82	BZX79C82RL		6-15
BZX79C8V2	BZX79C8V2RL		6-15
BZX79C91	BZX79C91RL		6-15
BZX79C9V1	BZX79C9V1RL		6-15
BZX83C10	BZX83C10RL		6-16
BZX83C11	BZX83C11RL		6-16
BZX83C12	BZX83C12RL		6-16
BZX83C13	BZX83C13RL		6-16
BZX83C15	BZX83C15RL		6-16
BZX83C16	BZX83C16RL		6-16
BZX83C18	BZX83C18RL		6-16
BZX83C20	BZX83C20RL		6-16
BZX83C22	BZX83C22RL		6-16
BZX83C24	BZX83C24RL		6-16
BZX83C27	BZX83C27RL		6-16
BZX83C2V7	BZX83C2V7RL		6-16
BZX83C30	BZX83C30RL		6-16
BZX83C33	BZX83C33RL		6-16
BZX83C3V0	BZX83C3V0RL		6-16
BZX83C3V3	BZX83C3V3RL		6-16
BZX83C3V6	BZX83C3V6RL		6-16

CF = consult factory representative

**CROSS-REFERENCE (continued)**

Industry Part Number	Motorola Direct Replacement	Motorola Similar Replacement	Page Number
BZX83C3V9	BZX83C3V9RL		6-16
BZX83C4V3	BZX83C4V3RL		6-16
BZX83C4V7	BZX83C4V7RL		6-16
BZX83C5V1	BZX83C5V1RL		6-16
BZX83C5V6	BZX83C5V6RL		6-16
BZX83C6V2	BZX83C6V2RL		6-16
BZX83C6V8	BZX83C6V8RL		6-16
BZX83C7V5	BZX83C7V5RL		6-16
BZX83C8V2	BZX83C8V2RL		6-16
BZX83C9V1	BZX83C9V1RL		6-16
BZX84C10L	BZX84C10LT1		7-5
BZX84C11L	BZX84C11LT1		7-5
BZX84C12L	BZX84C12LT1		7-5
BZX84C13L	BZX84C13LT1		7-5
BZX84C15L	BZX84C15LT1		7-5
BZX84C16L	BZX84C16LT1		7-5
BZX84C18L	BZX84C18LT1		7-5
BZX84C20L	BZX84C20LT1		7-5
BZX84C22L	BZX84C22LT1		7-5
BZX84C24L	BZX84C24LT1		7-5
BZX84C27L	BZX84C27LT1		7-5
BZX84C2V4L	BZX84C2V4LT1		7-5
BZX84C2V7L	BZX84C2V7LT1		7-5
BZX84C30L	BZX84C30LT1		7-5
BZX84C33L	BZX84C33LT1		7-5
BZX84C36L	BZX84C36LT1		7-5
BZX84C39L	BZX84C39LT1		7-5
BZX84C3V0L	BZX84C3V0LT1		7-5
BZX84C3V3L	BZX84C3V3LT1		7-5
BZX84C3V6L	BZX84C3V6LT1		7-5
BZX84C3V9L	BZX84C3V9LT1		7-5
BZX84C43L	BZX84C43LT1		7-5
BZX84C47L	BZX84C47LT1		7-5
BZX84C4V3L	BZX84C4V3LT1		7-5
BZX84C4V7L	BZX84C4V7LT1		7-5
BZX84C51L	BZX84C51LT1		7-5
BZX84C56L	BZX84C56LT1		7-5
BZX84C5V1L	BZX84C5V1LT1		7-5
BZX84C5V6L	BZX84C5V6LT1		7-5
BZX84C62L	BZX84C62LT1		7-5
BZX84C68L	BZX84C68LT1		7-5
BZX84C6V2L	BZX84C6V2LT1		7-5
BZX84C6V8L	BZX84C6V8LT1		7-5
BZX84C75L	BZX84C75LT1		7-5
BZX84C7V5L	BZX84C7V5LT1		7-5
BZX84C8V2L	BZX84C8V2LT1		7-5
BZX84C9V1L	BZX84C9V1LT1		7-5
BZX85C10	BZX85C10RL		6-25
BZX85C100	BZX85C100RL		6-25
BZX85C11	BZX85C11RL		6-25

Industry Part Number	Motorola Direct Replacement	Motorola Similar Replacement	Page Number
BZX85C12	BZX85C12RL		6-25
BZX85C13	BZX85C13RL		6-25
BZX85C15	BZX85C15RL		6-25
BZX85C16	BZX85C16RL		6-25
BZX85C18	BZX85C18RL		6-25
BZX85C20	BZX85C20RL		6-25
BZX85C22	BZX85C22RL		6-25
BZX85C24	BZX85C24RL		6-25
BZX85C27	BZX85C27RL		6-25
BZX85C30	BZX85C30RL		6-25
BZX85C33	BZX85C33RL		6-25
BZX85C36	BZX85C36RL		6-25
BZX85C39	BZX85C39RL		6-25
BZX85C3V3	BZX85C3V3RL		6-25
BZX85C3V6	BZX85C3V6RL		6-25
BZX85C3V9	BZX85C3V9RL		6-25
BZX85C43	BZX85C43RL		6-25
BZX85C47	BZX85C47RL		6-25
BZX85C4V3	BZX85C4V3RL		6-25
BZX85C4V7	BZX85C4V7RL		6-25
BZX85C51	BZX85C51RL		6-25
BZX85C56	BZX85C56RL		6-25
BZX85C5V1	BZX85C5V1RL		6-25
BZX85C5V6	BZX85C5V6RL		6-25
BZX85C62	BZX85C62RL		6-25
BZX85C68	BZX85C68RL		6-25
BZX85C6V2	BZX85C6V2RL		6-25
BZX85C6V8	BZX85C6V8RL		6-25
BZX85C75	BZX85C75RL		6-25
BZX85C7V5	BZX85C7V5RL		6-25
BZX85C82	BZX85C82RL		6-25
BZX85C8V2	BZX85C8V2RL		6-25
BZX85C91	BZX85C91RL		6-25
BZX85C9V1	BZX85C9V1RL		6-25
DTZ10		1.5KE10CA	4-17
DTZ100		1.5KE100CA	4-17
DTZ100A		1.5KE100CA	4-17
DTZ10A		1.5KE10CA	4-17
DTZ11		1.5KE11CA	4-17
DTZ110		1.5KE110CA	4-17
DTZ110A		1.5KE110CA	4-17
DTZ11A		1.5KE11CA	4-17
DTZ12		1.5KE12CA	4-17
DTZ120		1.5KE120CA	4-17
DTZ120A		1.5KE120CA	4-17
DTZ12A		1.5KE12CA	4-17
DTZ13		1.5KE13CA	4-17
DTZ130		1.5KE130CA	4-17
DTZ130A		1.5KE130CA	4-17
DTZ13A		1.5KE13CA	4-17

CF = consult factory representative

**CROSS-REFERENCE (continued)**

Industry Part Number	Motorola Direct Replacement	Motorola Similar Replacement	Page Number
DTZ15		1.5KE15CA	4-17
DTZ150		1.5KE150CA	4-17
DTZ150A		1.5KE150CA	4-17
DTZ15A		1.5KE15CA	4-17
DTZ16		1.5KE16CA	4-17
DTZ160		1.5KE160CA	4-17
DTZ160A		1.5KE160CA	4-17
DTZ16A		1.5KE16CA	4-17
DTZ170		1.5KE170CA	4-17
DTZ170A		1.5KE170CA	4-17
DTZ18		1.5KE18CA	4-17
DTZ180		1.5KE180CA	4-17
DTZ180A		1.5KE180CA	4-17
DTZ18A		1.5KE18CA	4-17
DTZ20		1.5KE20CA	4-17
DTZ200		1.5KE200CA	4-17
DTZ200A		1.5KE200CA	4-17
DTZ20A		1.5KE20CA	4-17
DTZ22		1.5KE22CA	4-17
DTZ220		1.5KE220CA	4-17
DTZ220A		1.5KE220CA	4-17
DTZ22A		1.5KE22CA	4-17
DTZ24		1.5KE24CA	4-17
DTZ24A		1.5KE24CA	4-17
DTZ250		1.5KE250CA	4-17
DTZ250A		1.5KE250CA	4-17
DTZ27		1.5KE27CA	4-17
DTZ27A		1.5KE27CA	4-17
DTZ30		1.5KE30CA	4-17
DTZ30A		1.5KE30CA	4-17
DTZ33		1.5KE33CA	4-17
DTZ33A		1.5KE33CA	4-17
DTZ36		1.5KE36CA	4-17
DTZ36A		1.5KE36CA	4-17
DTZ39		1.5KE39CA	4-17
DTZ39A		1.5KE39CA	4-17
DTZ43		1.5KE43CA	4-17
DTZ43A		1.5KE43CA	4-17
DTZ47		1.5KE47CA	4-17
DTZ47A		1.5KE47CA	4-17
DTZ51		1.5KE51CA	4-17
DTZ51A		1.5KE51CA	4-17
DTZ56		1.5KE56CA	4-17
DTZ56A		1.5KE56CA	4-17
DTZ62		1.5KE62CA	4-17
DTZ62A		1.5KE62CA	4-17
DTZ68		1.5KE68CA	4-17
DTZ68A		1.5KE68CA	4-17
DTZ6V8		1.5KE6.8CA	4-17
DTZ6V8A		1.5KE6.8CA	4-17

Industry Part Number	Motorola Direct Replacement	Motorola Similar Replacement	Page Number
DTZ75		1.5KE75CA	4-17
DTZ75A		1.5KE75CA	4-17
DTZ7V5		1.5KE7.5CA	4-17
DTZ7V5A		1.5KE7.5CA	4-17
DTZ82		1.5KE82CA	4-17
DTZ82A		1.5KE82CA	4-17
DTZ8V2		1.5KE8.2CA	4-17
DTZ8V2A		1.5KE8.2CA	4-17
DTZ91		1.5KE91CA	4-17
DTZ91A		1.5KE91CA	4-17
DTZ9V1		1.5KE9.1CA	4-17
DTZ9V1A		1.5KE9.1CA	4-17
GMP-5		1N6373	4-19
GMP-5A		1N6373	4-19
GMP-5B		1N6373	4-19
ICT-10		ICTE-10	4-19
ICT-10C		ICTE-10C	4-19
ICT-12		ICTE-12	4-19
ICT-12C		ICTE-12C	4-19
ICT-15		ICTE-15	4-19
ICT-15C		ICTE-15C	4-19
ICT-18		ICTE-18	4-19
ICT-18C		ICTE-18C	4-19
ICT-22		ICTE-22	4-19
ICT-22C		ICTE-22C	4-19
ICT-36		ICTE-36	4-19
ICT-36C		ICTE-36C	4-19
ICT-45		ICTE-45	4-19
ICT-45C		ICTE-45C	4-19
ICT-5		ICTE-5	4-19
ICT-8		ICTE-8	4-19
ICT-8C		ICTE-8C	4-19
ICTE-10	ICTE-10		4-19
ICTE-10C	ICTE-10C		4-19
ICTE-12	ICTE-12		4-19
ICTE-12C	ICTE-12C		4-19
ICTE-15	ICTE-15		4-19
ICTE-15C	ICTE-15C		4-19
ICTE-18	ICTE-18		4-19
ICTE-18C	ICTE-18C		4-19
ICTE-22	ICTE-22		4-19
ICTE-22C	ICTE-22C		4-19
ICTE-36	ICTE-36		4-19
ICTE-36C	ICTE-36C		4-19
ICTE-45	ICTE-45		4-19
ICTE-45C	ICTE-45C		4-19
ICTE-5	ICTE-5		4-19
ICTE-8	ICTE-8		4-19
ICTE-8C	ICTE-8C		4-19
LVA100A		MZ5530B	6-18

CF = consult factory representative

**CROSS-REFERENCE (continued)**

Industry Part Number	Motorola Direct Replacement	Motorola Similar Replacement	Page Number
LVA3100A		MZ5530B	6-18
LVA343A		MZ5521B	6-18
LVA347A		MZ5522B	6-18
LVA351A		MZ5523B	6-18
LVA356A		MZ5524B	6-18
LVA362A		MZ5525B	6-18
LVA368A		MZ5526B	6-18
LVA375A		MZ5527B	6-18
LVA382A		MZ5528B	6-18
LVA391A		MZ5529B	6-18
LVA43A		MZ5521B	6-18
LVA47A		MZ5522B	6-18
LVA51A		MZ5523B	6-18
LVA56A		MZ5524B	6-18
LVA62A		MZ5525B	6-18
LVA68A		MZ5526B	6-18
LVA75A		MZ5527B	6-18
LVA82A		MZ5528B	6-18
LVA91A		MZ5529B	6-18
MLL4099		MMSZ4692T1	7-13
MLL4100		MMSZ4693T1	7-13
MLL4101		MMSZ4694T1	7-13
MLL4102		MMSZ4695T1	7-13
MLL4103		MMSZ4696T1	7-13
MLL4104		MMSZ4697T1	7-13
MLL4105		MMSZ4698T1	7-13
MLL4106		MMSZ4699T1	7-13
MLL4107		MMSZ4700T1	7-13
MLL4108		MMSZ4701T1	7-13
MLL4109		MMSZ4702T1	7-13
MLL4110		MMSZ4703T1	7-13
MLL4111		MMSZ4704T1	7-13
MLL4112		MMSZ4705T1	7-13
MLL4113		MMSZ4706T1	7-13
MLL4114		MMSZ4707T1	7-13
MLL4115		MMSZ4708T1	7-13
MLL4116		MMSZ4709T1	7-13
MLL4117		MMSZ4710T1	7-13
MLL4118		MMSZ4711T1	7-13
MLL4119		MMSZ4712T1	7-13
MLL4120		MMSZ4713T1	7-13
MLL4121		MMSZ4714T1	7-13
MLL4122		MMSZ4715T1	7-13
MLL4123		MMSZ4716T1	7-13
MLL4124		MMSZ4717T1	7-13
MLL4125		MMSZ5261BT1	7-12
MLL4126		MMSZ5262BT1	7-12
MLL4127		MMSZ5263BT1	7-12
MLL4128		MMSZ5264BT1	7-12
MLL4129		MMSZ5265BT1	7-12

Industry Part Number	Motorola Direct Replacement	Motorola Similar Replacement	Page Number
MLL4130		MMSZ5266BT1	7-12
MLL4131		MMSZ5267BT1	7-12
MLL4132		MMSZ5268BT1	7-12
MLL4133		MMSZ5269BT1	7-12
MLL4134		MMSZ5270BT1	7-12
MLL4370A		MMSZ5221BT1	7-11
MLL4371A		MMSZ5223BT1	7-11
MLL4372A		MMSZ5225BT1	7-11
MLL4614		MMSZ4678T1	7-13
MLL4615		MMSZ4679T1	7-13
MLL4616		MMSZ4680T1	7-13
MLL4617		MMSZ4681T1	7-13
MLL4618		MMSZ4682T1	7-13
MLL4619		MMSZ4683T1	7-13
MLL4620		MMSZ4684T1	7-13
MLL4621		MMSZ4685T1	7-13
MLL4622		MMSZ4686T1	7-13
MLL4623		MMSZ4687T1	7-13
MLL4624		MMSZ4688T1	7-13
MLL4625		MMSZ4689T1	7-13
MLL4626		MMSZ4690T1	7-13
MLL4627		MMSZ4691T1	7-13
MLL4678		MMSZ4678T1	7-13
MLL4679		MMSZ4679T1	7-13
MLL4680		MMSZ4680T1	7-13
MLL4681		MMSZ4681T1	7-13
MLL4682		MMSZ4682T1	7-13
MLL4683		MMSZ4683T1	7-13
MLL4684		MMSZ4684T1	7-13
MLL4685		MMSZ4685T1	7-13
MLL4686		MMSZ4686T1	7-13
MLL4687		MMSZ4687T1	7-13
MLL4688		MMSZ4688T1	7-13
MLL4689		MMSZ4689T1	7-13
MLL4690		MMSZ4690T1	7-13
MLL4691		MMSZ4691T1	7-13
MLL4692		MMSZ4692T1	7-13
MLL4693		MMSZ4693T1	7-13
MLL4694		MMSZ4694T1	7-13
MLL4695		MMSZ4695T1	7-13
MLL4696		MMSZ4696T1	7-13
MLL4697		MMSZ4697T1	7-13
MLL4698		MMSZ4698T1	7-13
MLL4699		MMSZ4699T1	7-13
MLL4700		MMSZ4700T1	7-13
MLL4701		MMSZ4701T1	7-13
MLL4702		MMSZ4702T1	7-13
MLL4703		MMSZ4703T1	7-13
MLL4704		MMSZ4704T1	7-13
MLL4705		MMSZ4705T1	7-13

CF = consult factory representative

**CROSS-REFERENCE (continued)**

Industry Part Number	Motorola Direct Replacement	Motorola Similar Replacement	Page Number
MLL4706		MMSZ4706T1	7-13
MLL4707		MMSZ4707T1	7-13
MLL4708		MMSZ4708T1	7-13
MLL4709		MMSZ4709T1	7-13
MLL4710		MMSZ4710T1	7-13
MLL4711		MMSZ4711T1	7-13
MLL4712		MMSZ4712T1	7-13
MLL4713		MMSZ4713T1	7-13
MLL4714		MMSZ4714T1	7-13
MLL4715		MMSZ4715T1	7-13
MLL4716		MMSZ4716T1	7-13
MLL4717		MMSZ4717T1	7-13
MLL4728		1SMB5913BT3	7-17
MLL4728A		1SMB5913BT3	7-17
MLL4729		1SMB5914BT3	7-17
MLL4729A		1SMB5914BT3	7-17
MLL4730		1SMB5915BT3	7-17
MLL4730A		1SMB5915BT3	7-17
MLL4731		1SMB5916BT3	7-17
MLL4731A		1SMB5916BT3	7-17
MLL4732		1SMB5917BT3	7-17
MLL4732A		1SMB5917BT3	7-17
MLL4733		1SMB5918BT3	7-17
MLL4733A		1SMB5918BT3	7-17
MLL4734		1SMB5919BT3	7-17
MLL4734A		1SMB5919BT3	7-17
MLL4735		1SMB5920BT3	7-17
MLL4735A		1SMB5920BT3	7-17
MLL4736		1SMB5921BT3	7-17
MLL4736A		1SMB5921BT3	7-17
MLL4737		1SMB5922BT3	7-17
MLL4737A		1SMB5922BT3	7-17
MLL4738		1SMB5923BT3	7-17
MLL4738A		1SMB5923BT3	7-17
MLL4739		1SMB5924BT3	7-17
MLL4739A		1SMB5924BT3	7-17
MLL4740		1SMB5925BT3	7-17
MLL4740A		1SMB5925BT3	7-17
MLL4741		1SMB5926BT3	7-17
MLL4741A		1SMB5926BT3	7-17
MLL4742		1SMB5927BT3	7-17
MLL4742A		1SMB5927BT3	7-17
MLL4743		1SMB5928BT3	7-17
MLL4743A		1SMB5928BT3	7-17
MLL4744		1SMB5929BT3	7-18
MLL4744A		1SMB5929BT3	7-18
MLL4745		1SMB5930BT3	7-18
MLL4745A		1SMB5930BT3	7-18
MLL4746		1SMB5931BT3	7-18
MLL4746A		1SMB5931BT3	7-18

Industry Part Number	Motorola Direct Replacement	Motorola Similar Replacement	Page Number
MLL4747		1SMB5932BT3	7-18
MLL4747A		1SMB5932BT3	7-18
MLL4748		1SMB5933BT3	7-18
MLL4748A		1SMB5933BT3	7-18
MLL4749		1SMB5934BT3	7-18
MLL4749A		1SMB5934BT3	7-18
MLL4750		1SMB5935BT3	7-18
MLL4750A		1SMB5935BT3	7-18
MLL4751		1SMB5936BT3	7-18
MLL4751A		1SMB5936BT3	7-18
MLL4752		1SMB5937BT3	7-18
MLL4752A		1SMB5937BT3	7-18
MLL4753		1SMB5938BT3	7-18
MLL4753A		1SMB5938BT3	7-18
MLL4754		1SMB5939BT3	7-18
MLL4754A		1SMB5939BT3	7-18
MLL4755		1SMB5940BT3	7-18
MLL4755A		1SMB5940BT3	7-18
MLL4756		1SMB5941BT3	7-18
MLL4756A		1SMB5941BT3	7-18
MLL4757		1SMB5942BT3	7-18
MLL4757A		1SMB5942BT3	7-18
MLL4758		1SMB5943BT3	7-18
MLL4758A		1SMB5943BT3	7-18
MLL4759		1SMB5944BT3	7-18
MLL4759A		1SMB5944BT3	7-18
MLL4760		1SMB5945BT3	7-18
MLL4760A		1SMB5945BT3	7-18
MLL4761		1SMB5946BT3	7-18
MLL4761A		1SMB5946BT3	7-18
MLL4762		1SMB5947BT3	7-18
MLL4762A		1SMB5947BT3	7-18
MLL4763		1SMB5948BT3	7-18
MLL4763A		1SMB5948BT3	7-18
MLL4764		1SMB5949BT3	7-18
MLL4764A		1SMB5949BT3	7-18
MLL5221B		MMSZ5221BT1	7-11
MLL5222B		MMSZ5222BT1	7-11
MLL5223B		MMSZ5223BT1	7-11
MLL5224B		MMSZ5224BT1	7-11
MLL5225B		MMSZ5225BT1	7-11
MLL5226B		MMSZ5226BT1	7-11
MLL5227B		MMSZ5227BT1	7-11
MLL5228B		MMSZ5228BT1	7-11
MLL5229B		MMSZ5229BT1	7-11
MLL5230B		MMSZ5230BT1	7-11
MLL5231B		MMSZ5231BT1	7-11
MLL5232B		MMSZ5232BT1	7-11
MLL5233B		MMSZ5233BT1	7-11
MLL5234B		MMSZ5234BT1	7-11

CF = consult factory representative

**CROSS-REFERENCE (continued)**

Industry Part Number	Motorola Direct Replacement	Motorola Similar Replacement	Page Number
MLL5235B		MMSZ5235BT1	7-11
MLL5236B		MMSZ5236BT1	7-11
MLL5237B		MMSZ5237BT1	7-11
MLL5238B		MMSZ5238BT1	7-11
MLL5239B		MMSZ5239BT1	7-11
MLL5240B		MMSZ5240BT1	7-11
MLL5241B		MMSZ5241BT1	7-11
MLL5242B		MMSZ5242BT1	7-11
MLL5243B		MMSZ5243BT1	7-11
MLL5244B		MMSZ5244BT1	7-11
MLL5245B		MMSZ5245BT1	7-11
MLL5246B		MMSZ5246BT1	7-11
MLL5247B		MMSZ5247BT1	7-11
MLL5248B		MMSZ5248BT1	7-11
MLL5249B		MMSZ5249BT1	7-11
MLL5250B		MMSZ5250BT1	7-11
MLL5251B		MMSZ5251BT1	7-11
MLL5252B		MMSZ5252BT1	7-11
MLL5253B		MMSZ5253BT1	7-11
MLL5254B		MMSZ5254BT1	7-11
MLL5255B		MMSZ5255BT1	7-11
MLL5256B		MMSZ5256BT1	7-12
MLL5257B		MMSZ5257BT1	7-12
MLL5258B		MMSZ5258BT1	7-12
MLL5259B		MMSZ5259BT1	7-12
MLL5260B		MMSZ5260BT1	7-12
MLL5261B		MMSZ5261BT1	7-12
MLL5262B		MMSZ5262BT1	7-12
MLL5263B		MMSZ5263BT1	7-12
MLL5264B		MMSZ5264BLT1	7-12
MLL5265B		MMSZ5265BLT1	7-12
MLL5266B		MMSZ5266BLT1	7-12
MLL5267B		MMSZ5267BLT1	7-12
MLL5268B		MMSZ5268BLT1	7-12
MLL5269B		MMSZ5269BLT1	7-12
MLL5270B		MMSZ5270BLT1	7-12
MLL5913A,B		1SMB5913BT3	7-17
MLL5914A,B		1SMB5914BT3	7-17
MLL5915A,B		1SMB5915BT3	7-17
MLL5916A,B		1SMB5916BT3	7-17
MLL5917A,B		1SMB5917BT3	7-17
MLL5918A,B		1SMB5918BT3	7-17
MLL5919A,B		1SMB5919BT3	7-17
MLL5920A,B		1SMB5920BT3	7-17
MLL5921A,B		1SMB5921BT3	7-17
MLL5922A,B		1SMB5922BT3	7-17
MLL5923A,B		1SMB5923BT3	7-17
MLL5924A,B		1SMB5924BT3	7-17
MLL5925A,B		1SMB5925BT3	7-17
MLL5926A,B		1SMB5926BT3	7-17

Industry Part Number	Motorola Direct Replacement	Motorola Similar Replacement	Page Number
MLL5927A,B		1SMB5927BT3	7-17
MLL5928A,B		1SMB5928BT3	7-17
MLL5929A,B		1SMB5929BT3	7-18
MLL5930A,B		1SMB5930BT3	7-18
MLL5931A,B		1SMB5931BT3	7-18
MLL5932A,B		1SMB5932BT3	7-18
MLL5933A,B		1SMB5933BT3	7-18
MLL5934A,B		1SMB5934BT3	7-18
MLL5935A,B		1SMB5935BT3	7-18
MLL5936A,B		1SMB5936BT3	7-18
MLL5937A,B		1SMB5937BT3	7-18
MLL5938A,B		1SMB5938BT3	7-18
MLL5939A,B		1SMB5939BT3	7-18
MLL5940A,B		1SMB5940BT3	7-18
MLL5941A,B		1SMB5941BT3	7-18
MLL5942A,B		1SMB5942BT3	7-18
MLL5943A,B		1SMB5943BT3	7-18
MLL5944A,B		1SMB5944BT3	7-18
MLL5945A,B		1SMB5945BT3	7-18
MLL5946A,B		1SMB5946BT3	7-18
MLL5947A,B		1SMB5947BT3	7-18
MLL5948A,B		1SMB5948BT3	7-18
MLL5949A,B		1SMB5949BT3	7-18
MLL5950A,B		1SMB5950BT3	7-18
MLL5951A,B		1SMB5951BT3	7-18
MLL5952A,B		1SMB5952BT3	7-18
MLL5953A,B		1SMB5953BT3	7-18
MLL5954A,B		1SMB5954BT3	7-18
MLL5955A,B		1SMB5955BT3	7-18
MLL5956A,B		1SMB5956BT3	7-18
MLL746A		MMSZ5226BT1	7-11
MLL747A		MMSZ5227BT1	7-11
MLL748A		MMSZ5228BT1	7-11
MLL749A		MMSZ5229BT1	7-11
MLL750A		MMSZ5230BT1	7-11
MLL751A		MMSZ5231BT1	7-11
MLL752A		MMSZ5232BT1	7-11
MLL753A		MMSZ5234BT1	7-11
MLL754A		MMSZ5235BT1	7-11
MLL755A		MMSZ5236BT1	7-11
MLL756A		MMSZ5237BT1	7-11
MLL757A		MMSZ5239BT1	7-11
MLL758A		MMSZ5240BT1	7-11
MLL759A		MMSZ5242BT1	7-11
MLL957B		MMSZ5235BT1	7-11
MLL958B		MMSZ5236BT1	7-11
MLL959B		MMSZ5237BT1	7-11
MLL960B		MMSZ5239BT1	7-11
MLL961B		MMSZ5240BT1	7-11
MLL962B		MMSZ5241BT1	7-11

CF = consult factory representative

**CROSS-REFERENCE (continued)**

Industry Part Number	Motorola Direct Replacement	Motorola Similar Replacement	Page Number
MLL963B		MMSZ5242BT1	7-11
MLL964B		MMSZ5243BT1	7-11
MLL965B		MMSZ5245BT1	7-11
MLL966B		MMSZ5246BT1	7-11
MLL967B		MMSZ5248BT1	7-11
MLL968B		MMSZ5250BT1	7-11
MLL969B		MMSZ5251BT1	7-11
MLL970B		MMSZ5252BT1	7-11
MLL971B		MMSZ5254BT1	7-11
MLL972B		MMSZ5256BT1	7-12
MLL973B		MMSZ5257BT1	7-12
MLL974B		MMSZ5258BT1	7-12
MLL975B		MMSZ5259BT1	7-12
MLL976B		MMSZ5260BT1	7-12
MLL977B		MMSZ5261BT1	7-12
MLL978B		MMSZ5262BT1	7-12
MLL979B		MMSZ5263BT1	7-12
MLL980B		MMSZ5265BT1	7-12
MLL981B		MMSZ5266BT1	7-12
MLL982B		MMSZ5267BT1	7-12
MLL983B		MMSZ5268BT1	7-12
MLL984B		MMSZ5270BT1	7-12
MMBZ15VDLT1	MMBZ15VDLT1		7-6
MMBZ5221BL	MMBZ5221BLT1		7-6
MMBZ5222BL	MMBZ5222BLT1		7-6
MMBZ5223BL	MMBZ5223BLT1		7-6
MMBZ5224BL	MMBZ5224BLT1		7-6
MMBZ5225BL	MMBZ5225BLT1		7-6
MMBZ5226BL	MMBZ5226BLT1		7-6
MMBZ5227BL	MMBZ5227BLT1		7-6
MMBZ5228BL	MMBZ5228BLT1		7-6
MMBZ5229BL	MMBZ5229BLT1		7-6
MMBZ5230BL	MMBZ5230BLT1		7-6
MMBZ5231BL	MMBZ5231BLT1		7-6
MMBZ5232BL	MMBZ5232BLT1		7-6
MMBZ5233BL	MMBZ5233BLT1		7-6
MMBZ5234BL	MMBZ5234BLT1		7-6
MMBZ5235BL	MMBZ5235BLT1		7-6
MMBZ5236BL	MMBZ5236BLT1		7-6
MMBZ5237BL	MMBZ5237BLT1		7-6
MMBZ5238BL	MMBZ5238BLT1		7-6
MMBZ5239BL	MMBZ5239BLT1		7-6
MMBZ5240BL	MMBZ5240BLT1		7-6
MMBZ5241BL	MMBZ5241BLT1		7-6
MMBZ5242BL	MMBZ5242BLT1		7-6
MMBZ5243BL	MMBZ5243BLT1		7-6
MMBZ5244BL	MMBZ5244BLT1		7-6
MMBZ5245BL	MMBZ5245BLT1		7-6
MMBZ5246BL	MMBZ5246BLT1		7-6
MMBZ5247BL	MMBZ5247BLT1		7-6

Industry Part Number	Motorola Direct Replacement	Motorola Similar Replacement	Page Number
MMBZ5248BL	MMBZ5248BLT1		7-6
MMBZ5249BL	MMBZ5249BLT1		7-6
MMBZ5250BL	MMBZ5250BLT1		7-6
MMBZ5251BL	MMBZ5251BLT1		7-6
MMBZ5252BL	MMBZ5252BLT1		7-6
MMBZ5253BL	MMBZ5253BLT1		7-6
MMBZ5254BL	MMBZ5254BLT1		7-6
MMBZ5255BL	MMBZ5255BLT1		7-6
MMBZ5256BL	MMBZ5256BLT1		7-6
MMBZ5257BL	MMBZ5257BLT1		7-6
MMBZ5258BL	MMBZ5258BLT1		7-6
MMBZ5259BL	MMBZ5259BLT1		7-6
MMBZ5260BL	MMBZ5260BLT1		7-6
MMBZ5261BL	MMBZ5261BLT1		7-6
MMBZ5262BL	MMBZ5262BLT1		7-6
MMBZ5263BL	MMBZ5263BLT1		7-6
MMBZ5264BL	MMBZ5264BLT1		7-6
MMBZ5265BL	MMBZ5265BLT1		7-6
MMBZ5266BL	MMBZ5266BLT1		7-6
MMBZ5267BL	MMBZ5267BLT1		7-6
MMBZ5268BL	MMBZ5268BLT1		7-6
MMBZ5269BL	MMBZ5269BLT1		7-6
MMBZ5270BL	MMBZ5270BLT1		7-6
MMBZ5V6ALT1	MMBZ5V6ALT1		5-2
MPT-10		MPTE-10	4-19
MPT-10C		MPTE-10C	4-19
MPT-12		MPTE-12	4-19
MPT-12C		MPTE-12C	4-19
MPT-15		MPTE-15	4-19
MPT-15C		MPTE-15C	4-19
MPT-18		MPTE-18	4-19
MPT-18C		MPTE-18C	4-19
MPT-22		MPTE-22	4-19
MPT-22C		MPTE-22C	4-19
MPT-36		MPTE-36	4-19
MPT-36C		MPTE-36C	4-19
MPT-45		MPTE-45	4-19
MPT-45C		MPTE-45C	4-19
MPT-5		MPTE-5	4-19
MPT-8		MPTE-8	4-19
MPT-8C		MPTE-8C	4-19
MPTE-10	MPTE-10		4-19
MPTE-10C	MPTE-10C		4-19
MPTE-12	MPTE-12		4-19
MPTE-12C	MPTE-12C		4-19
MPTE-15	MPTE-15		4-19
MPTE-15C	MPTE-15C		4-19
MPTE-18	MPTE-18		4-19
MPTE-18C	MPTE-18C		4-19
MPTE-22	MPTE-22		4-19

CF = consult factory representative



**CROSS-REFERENCE (continued)**

Industry Part Number	Motorola Direct Replacement	Motorola Similar Replacement	Page Number
MPTE-22C	MPTE-22C		4-19
MPTE-36	MPTE-36		4-19
MPTE-36C	MPTE-36C		4-19
MPTE-45	MPTE-45		4-19
MPTE-45C	MPTE-45C		4-19
MPTE-5	MPTE-5		4-19
MPTE-8	MPTE-8		4-19
MPTE-8C	MPTE-8C		4-19
MR2535L	MR2535L		4-21
MZ1000-1	1N4728A		6-24
MZ1000-10	1N4737A		6-24
MZ1000-11	1N4738A		6-24
MZ1000-12	1N4739A		6-24
MZ1000-13	1N4740A		6-24
MZ1000-14	1N4741A		6-24
MZ1000-15	1N4742A		6-24
MZ1000-16	1N4743A		6-24
MZ1000-17	1N4744A		6-24
MZ1000-18	1N4745A		6-24
MZ1000-19	1N4746A		6-24
MZ1000-2	1N4729A		6-24
MZ1000-20	1N4747A		6-24
MZ1000-21	1N4748A		6-24
MZ1000-22	1N4749A		6-24
MZ1000-23	1N4750A		6-24
MZ1000-24	1N4751A		6-24
MZ1000-25	1N4752A		6-24
MZ1000-26	1N4753A		6-24
MZ1000-27	1N4754A		6-24
MZ1000-28	1N4755A		6-24
MZ1000-29	1N4756A		6-24
MZ1000-3	1N4730A		6-24
MZ1000-30	1N4757A		6-24
MZ1000-31	1N4758A		6-24
MZ1000-32	1N4759A		6-24
MZ1000-33	1N4760A		6-24
MZ1000-34	1N4761A		6-24
MZ1000-35	1N4762A		6-24
MZ1000-36	1N4763A		6-24
MZ1000-37	1N4764A		6-24
MZ1000-4	1N4731A		6-24
MZ1000-5	1N4732A		6-24
MZ1000-6	1N4733A		6-24
MZ1000-7	1N4734A		6-24
MZ1000-8	1N4735A		6-24
MZ1000-9	1N4736A		6-24
MZ4099	MZ4099		6-17
MZ4100	MZ4100		6-17
MZ4101	MZ4101		6-17
MZ4102	MZ4102		6-17

Industry Part Number	Motorola Direct Replacement	Motorola Similar Replacement	Page Number
MZ4103	MZ4103		6-17
MZ4104	MZ4104		6-17
MZ4614	MZ4614		6-17
MZ4615	MZ4615		6-17
MZ4616	MZ4616		6-17
MZ4617	MZ4617		6-17
MZ4618	MZ4618		6-17
MZ4619	MZ4619		6-17
MZ4620	MZ4620		6-17
MZ4621	MZ4621		6-17
MZ4622	MZ4622		6-17
MZ4623	MZ4623		6-17
MZ4624	MZ4624		6-17
MZ4625	MZ4625		6-17
MZ4626	MZ4626		6-17
MZ4627	MZ4627		6-17
MZ4678	1N4678		6-10
MZ4679	1N4679		6-10
MZ4680	1N4680		6-10
MZ4681	1N4681		6-10
MZ4682	1N4682		6-10
MZ4683	1N4683		6-10
MZ4684	1N4684		6-10
MZ4685	1N4685		6-10
MZ4686	1N4686		6-10
MZ4687	1N4687		6-10
MZ4688	1N4688		6-10
MZ4689	1N4689		6-10
MZ4690	1N4690		6-10
MZ4691	1N4691		6-10
MZ4692	1N4692		6-10
MZ4693	1N4693		6-10
MZ4694	1N4694		6-10
MZ4695	1N4695		6-10
MZ4696	1N4696		6-10
MZ4697	1N4697		6-10
MZ4698	1N4698		6-10
MZ4699	1N4699		6-10
MZ4700	1N4700		6-10
MZ4701	1N4701		6-10
MZ4702	1N4702		6-10
MZ4703	1N4703		6-10
MZ4704	1N4704		6-10
MZ4705	1N4705		6-10
MZ4706	1N4706		6-10
MZ4707	1N4707		6-10
MZ4708	1N4708		6-10
MZ4709	1N4709		6-10
MZ4710	1N4710		6-10
MZ4711	1N4711		6-10

CF = consult factory representative

**CROSS-REFERENCE (continued)**

Industry Part Number	Motorola Direct Replacement	Motorola Similar Replacement	Page Number
MZ4712	1N4712		6-10
MZ4713	1N4713		6-10
MZ4714	1N4714		6-10
MZ4715	1N4715		6-10
MZ4716	1N4716		6-10
MZ4717	1N4717		6-10
MZ500-1	1N5221B		6-11
MZ500-10	1N5232B		6-11
MZ500-11	1N5234B		6-11
MZ500-12	1N5235B		6-11
MZ500-13	1N5236B		6-11
MZ500-14	1N5237B		6-11
MZ500-15	1N5239B		6-11
MZ500-16	1N5240B		6-11
MZ500-17	1N5241B		6-11
MZ500-18	1N5242B		6-11
MZ500-19	1N5243B		6-11
MZ500-2	1N5223B		6-11
MZ500-20	1N5245B		6-11
MZ500-21	1N5246B		6-11
MZ500-22	1N5248B		6-11
MZ500-23	1N5250B		6-11
MZ500-24	1N5251B		6-11
MZ500-25	1N5252B		6-11
MZ500-26	1N5254B		6-11
MZ500-27	1N5256B		6-11
MZ500-28	1N5257B		6-11
MZ500-29	1N5258B		6-11
MZ500-3	1N5225B		6-11
MZ500-30	1N5259B		6-11
MZ500-31	1N5260B		6-11
MZ500-32	1N5261B		6-11
MZ500-33	1N5262B		6-11
MZ500-34	1N5263B		6-11
MZ500-35	1N5265B		6-11
MZ500-36	1N5266B		6-12
MZ500-37	1N5267B		6-12
MZ500-38	1N5268B		6-12
MZ500-39	1N5270B		6-12
MZ500-4	1N5226B		6-11
MZ500-40	1N5271B		6-12
MZ500-5	1N5227B		6-11
MZ500-6	1N5228B		6-11
MZ500-7	1N5229B		6-11
MZ500-8	1N5230B		6-11
MZ500-9	1N5231B		6-11
MZ5520B	MZ5520B		6-18
MZ5521B	MZ5521B		6-18
MZ5522B	MZ5522B		6-18
MZ5523B	MZ5523B		6-18

Industry Part Number	Motorola Direct Replacement	Motorola Similar Replacement	Page Number
MZ5524B	MZ5524B		6-18
MZ5525B	MZ5525B		6-18
MZ5526B	MZ5526B		6-18
MZ5527B	MZ5527B		6-18
MZ5528B	MZ5528B		6-18
MZ5529B	MZ5529B		6-18
MZ5530B	MZ5530B		6-18
MZ5555		1N6284A	4-17
MZ5556		1N6287A	4-17
MZ5557		1N6289A	4-17
MZ5558		1N6303A	4-17
MZ623-10		1N4744A	6-24
MZ623-10A		1N4744A	6-24
MZ623-10B		1N4744A	6-24
MZ623-11		1N4745A	6-24
MZ623-11A		1N4745A	6-24
MZ623-11B		1N4745A	6-24
MZ623-12		1N4746A	6-24
MZ623-12A		1N4746A	6-24
MZ623-12B		1N4746A	6-24
MZ623-13		1N4746A	6-24
MZ623-13A		1N4746A	6-24
MZ623-13B		1N4746A	6-24
MZ623-14		1N4747A	6-24
MZ623-14A		1N4747A	6-24
MZ623-14B		1N4747A	6-24
MZ623-15		1N4747A	6-24
MZ623-15A		1N4747A	6-24
MZ623-15B		1N4747A	6-24
MZ623-16		1N4748A	6-24
MZ623-16A		1N4748A	6-24
MZ623-16B		1N4748A	6-24
MZ623-17		1N4749A	6-24
MZ623-17A		1N4749A	6-24
MZ623-17B		1N4749A	6-24
MZ623-18		1N4749A	6-24
MZ623-18A		1N4749A	6-24
MZ623-18B		1N4749A	6-24
MZ623-19		1N4750A	6-24
MZ623-19A		1N4750A	6-24
MZ623-19B		1N4750A	6-24
MZ623-20		1N4751A	6-24
MZ623-20A		1N4751A	6-24
MZ623-20B		1N4751A	6-24
MZ623-21		1N4752A	6-24
MZ623-21A		1N4752A	6-24
MZ623-21B		1N4752A	6-24
MZ623-22		1N4753A	6-24
MZ623-22A		1N4753A	6-24
MZ623-22B		1N4753A	6-24

CF = consult factory representative

**CROSS-REFERENCE (continued)**

Industry Part Number	Motorola Direct Replacement	Motorola Similar Replacement	Page Number
MZ623-23		1N4754A	6-24
MZ623-23A		1N4754A	6-24
MZ623-23B		1N4754A	6-24
MZ623-24		1N4755A	6-24
MZ623-24A		1N4755A	6-24
MZ623-24B		1N4755A	6-24
MZ623-25		1N4756A	6-24
MZ623-25A		1N4756A	6-24
MZ623-25B		1N4756A	6-24
MZ623-26		1N4756A	6-24
MZ623-26A		1N4756A	6-24
MZ623-26B		1N4756A	6-24
MZ623-27		1N4757A	6-24
MZ623-27A		1N4757A	6-24
MZ623-27B		1N4757A	6-24
MZ623-6		1N4741A	6-24
MZ623-6A		1N4741A	6-24
MZ623-6B		1N4741A	6-24
MZ623-7		1N4742A	6-24
MZ623-7A		1N4742A	6-24
MZ623-7B		1N4742A	6-24
MZ623-8		1N4743A	6-24
MZ623-8A		1N4743A	6-24
MZ623-8B		1N4743A	6-24
MZ623-9		1N4744A	6-24
MZ623-9A		1N4744A	6-24
MZ623-9B		1N4744A	6-24
MZ70-100B	1N5271B		6-12
MZ70-10B	1N5240B		6-11
MZ70-110B	1N5272B		6-12
MZ70-11B	1N5241B		6-11
MZ70-120B	1N5273B		6-12
MZ70-12B	1N5242B		6-11
MZ70-130B	1N5274B		6-12
MZ70-13B	1N5243B		6-11
MZ70-140B	1N5275B		6-12
MZ70-14B	1N5244B		6-11
MZ70-150B	1N5276B		6-12
MZ70-15B	1N5245B		6-11
MZ70-160B	1N5277B		6-12
MZ70-16B	1N5246B		6-11
MZ70-170B	1N5278B		6-12
MZ70-17B	1N5247B		6-11
MZ70-180B	1N5279B		6-12
MZ70-18B	1N5248B		6-11
MZ70-190B	1N5280B		6-12
MZ70-19B	1N5249B		6-11
MZ70-2.4B	1N5221B		6-11
MZ70-2.5B	1N5222B		6-11
MZ70-2.7B	1N5223B		6-11

Industry Part Number	Motorola Direct Replacement	Motorola Similar Replacement	Page Number
MZ70-2.8B	1N5224B		6-11
MZ70-200B	1N5281B		6-12
MZ70-20B	1N5250B		6-11
MZ70-22B	1N5251B		6-11
MZ70-24B	1N5252B		6-11
MZ70-25B	1N5253B		6-11
MZ70-27B	1N5254B		6-11
MZ70-28B	1N5255B		6-11
MZ70-3.3B	1N5226B		6-11
MZ70-3.6B	1N5227B		6-11
MZ70-3.9B	1N5228B		6-11
MZ70-30B	1N5256B		6-11
MZ70-33B	1N5257B		6-11
MZ70-36B	1N5258B		6-11
MZ70-39B	1N5259B		6-11
MZ70-3B	1N5225B		6-11
MZ70-4.3B	1N5229B		6-11
MZ70-4.7B	1N5230B		6-11
MZ70-43B	1N5260B		6-11
MZ70-47B	1N5261B		6-11
MZ70-5.1B	1N5231B		6-11
MZ70-5.6B	1N5232B		6-11
MZ70-51B	1N5262B		6-11
MZ70-56B	1N5263B		6-11
MZ70-6.2B	1N5234B		6-11
MZ70-6.8B	1N5235B		6-11
MZ70-60B	1N5264B		6-11
MZ70-62B	1N5265B		6-11
MZ70-68B	1N5266B		6-12
MZ70-6B	1N5233B		6-11
MZ70-7.5B	1N5236B		6-11
MZ70-75B	1N5267B		6-12
MZ70-8.2B	1N5237B		6-11
MZ70-8.7B	1N5238B		6-11
MZ70-82B	1N5268B		6-12
MZ70-87B	1N5269B		6-12
MZ70-9.1B	1N5239B		6-11
MZ70-91B	1N5270B		6-12
MZ92-100B		1N5271B	6-12
MZ92-10B		1N5240B	6-11
MZ92-110B		1N5272B	6-12
MZ92-11B		1N5241B	6-11
MZ92-120B		1N5273B	6-12
MZ92-12B		1N5242B	6-11
MZ92-130B		1N5274B	6-12
MZ92-13B		1N5243B	6-11
MZ92-140B		1N5275B	6-12
MZ92-14B		1N5244B	6-11
MZ92-150B		1N5276B	6-12
MZ92-15B		1N5245B	6-11

CF = consult factory representative

**CROSS-REFERENCE (continued)**

Industry Part Number	Motorola Direct Replacement	Motorola Similar Replacement	Page Number
MZ92-160B		1N5277B	6-12
MZ92-16B		1N5246B	6-11
MZ92-170B		1N5278B	6-12
MZ92-17B		1N5247B	6-11
MZ92-180B		1N5279B	6-12
MZ92-18B		1N5248B	6-11
MZ92-190B		1N5280B	6-12
MZ92-19B		1N5249B	6-11
MZ92-2.4B		1N5221B	6-11
MZ92-2.5B		1N5222B	6-11
MZ92-2.7B		1N5223B	6-11
MZ92-2.8B		1N5224B	6-11
MZ92-200B		1N5281B	6-12
MZ92-20B		1N5250B	6-11
MZ92-22B		1N5251B	6-11
MZ92-24B		1N5252B	6-11
MZ92-25B		1N5253B	6-11
MZ92-27B		1N5254B	6-11
MZ92-28B		1N5255B	6-11
MZ92-3.3B		1N5226B	6-11
MZ92-3.6B		1N5227B	6-11
MZ92-3.9B		1N5228B	6-11
MZ92-30B		1N5256B	6-11
MZ92-33B		1N5257B	6-11
MZ92-36B		1N5258B	6-11
MZ92-39B		1N5259B	6-11
MZ92-3B		1N5225B	6-11
MZ92-4.3B		1N5229B	6-11
MZ92-4.7B		1N5230B	6-11
MZ92-43B		1N5260B	6-11
MZ92-47B		1N5261B	6-11
MZ92-5.1B		1N5231B	6-11
MZ92-5.6B		1N5232B	6-11
MZ92-51B		1N5262B	6-11
MZ92-56B		1N5263B	6-11
MZ92-6.2B		1N5234B	6-11
MZ92-6.8B		1N5235B	6-11
MZ92-60B		1N5264B	6-11
MZ92-62B		1N5265B	6-12
MZ92-68B		1N5266B	6-12
MZ92-6B		1N5233B	6-11
MZ92-7.5B		1N5236B	6-11
MZ92-75B		1N5267B	6-12
MZ92-8.2B		1N5237B	6-11
MZ92-8.7B		1N5238B	6-11
MZ92-82B		1N5268B	6-12
MZ92-87B		1N5269B	6-12
MZ92-9.1B		1N5239B	6-11
MZ92-91B		1N5270B	6-12
MZD10	MZD10		6-35

Industry Part Number	Motorola Direct Replacement	Motorola Similar Replacement	Page Number
MZD100	MZD100		6-35
MZD11	MZD11		6-35
MZD110	MZD110		6-35
MZD12	MZD12		6-35
MZD120	MZD120		6-35
MZD13	MZD13		6-35
MZD130	MZD130		6-35
MZD15	MZD15		6-35
MZD150	MZD150		6-35
MZD16	MZD16		6-35
MZD160	MZD160		6-35
MZD18	MZD18		6-35
MZD180	MZD180		6-35
MZD20	MZD20		6-35
MZD200	MZD200		6-35
MZD22	MZD22		6-35
MZD24	MZD24		6-35
MZD27	MZD27		6-35
MZD3.9	MZD3.9		6-35
MZD30	MZD30		6-35
MZD33	MZD33		6-35
MZD36	MZD36		6-35
MZD39	MZD39		6-35
MZD4.3	MZD4.3		6-35
MZD4.7	MZD4.7		6-35
MZD43	MZD43		6-35
MZD47	MZD47		6-35
MZD5.1	MZD5.1		6-35
MZD5.6	MZD5.6		6-35
MZD51	MZD51		6-35
MZD56	MZD56		6-35
MZD6.2	MZD6.2		6-35
MZD6.8	MZD6.8		6-35
MZD62	MZD62		6-35
MZD68	MZD68		6-35
MZD7.5	MZD7.5		6-35
MZD75	MZD75		6-35
MZD8.2	MZD8.2		6-35
MZD82	MZD82		6-35
MZD9.1	MZD9.1		6-35
MZD91	MZD91		6-35
MZP4728A	MZP4728A		6-36
MZP4729A	MZP4729A		6-36
MZP4730A	MZP4730A		6-36
MZP4731A	MZP4731A		6-36
MZP4732A	MZP4732A		6-36
MZP4733A	MZP4733A		6-36
MZP4734A	MZP4734A		6-36
MZP4735A	MZP4735A		6-36
MZP4736A	MZP4736A		6-36

CF = consult factory representative

**CROSS-REFERENCE (continued)**

Industry Part Number	Motorola Direct Replacement	Motorola Similar Replacement	Page Number
MZP4737A	MZP4737A		6-36
MZP4738A	MZP4738A		6-36
MZP4739A	MZP4739A		6-36
MZP4740A	MZP4740A		6-36
MZP4741A	MZP4741A		6-36
MZP4742A	MZP4742A		6-36
MZP4743A	MZP4743A		6-36
MZP4744A	MZP4744A		6-36
MZP4745A	MZP4745A		6-36
MZP4746A	MZP4746A		6-36
MZP4747A	MZP4747A		6-36
MZP4748A	MZP4748A		6-36
MZP4749A	MZP4749A		6-36
MZP4750A	MZP4750A		6-36
MZP4751A	MZP4751A		6-36
MZP4752A	MZP4752A		6-36
MZP4753A	MZP4753A		6-36
MZP4754A	MZP4754A		6-36
MZP4755A	MZP4755A		6-36
MZP4756A	MZP4756A		6-36
MZP4757A	MZP4757A		6-36
MZP4758A	MZP4758A		6-36
MZP4759A	MZP4759A		6-36
MZP4760A	MZP4760A		6-36
MZP4761A	MZP4761A		6-36
MZP4762A	MZP4762A		6-36
MZP4763A	MZP4763A		6-36
MZP4764A	MZP4764A		6-36
MZPY10	MZPY10		6-26
MZPY100	MZPY100		6-26
MZPY11	MZPY11		6-26
MZPY12	MZPY12		6-26
MZPY13	MZPY13		6-26
MZPY15	MZPY15		6-26
MZPY16	MZPY16		6-26
MZPY18	MZPY18		6-26
MZPY20	MZPY20		6-26
MZPY22	MZPY22		6-26
MZPY24	MZPY24		6-26
MZPY27	MZPY27		6-26
MZPY3.9	MZPY3.9		6-26
MZPY30	MZPY30		6-26
MZPY33	MZPY33		6-26
MZPY36	MZPY36		6-26
MZPY39	MZPY39		6-26
MZPY4.3	MZPY4.3		6-26
MZPY4.7	MZPY4.7		6-26
MZPY43	MZPY43		6-26
MZPY47	MZPY47		6-26
MZPY5.1	MZPY5.1		6-26

Industry Part Number	Motorola Direct Replacement	Motorola Similar Replacement	Page Number
MZPY5.6	MZPY5.6		6-26
MZPY51	MZPY51		6-26
MZPY56	MZPY56		6-26
MZPY6.2	MZPY6.2		6-26
MZPY6.8	MZPY6.8		6-26
MZPY62	MZPY62		6-26
MZPY68	MZPY68		6-26
MZPY7.5	MZPY7.5		6-26
MZPY75	MZPY75		6-26
MZPY8.2	MZPY8.2		6-26
MZPY82	MZPY82		6-26
MZPY9.1	MZPY9.1		6-26
MZPY91	MZPY91		6-26
P5KE100A		P6KE120A	4-7
P5KE100CA		P6KE120CA	4-7
P5KE10A		P6KE12A	4-7
P5KE10CA		P6KE12CA	4-7
P5KE110A		P6KE130A	4-7
P5KE110CA		P6KE130CA	4-7
P5KE11A		P6KE13A	4-7
P5KE11CA		P6KE13CA	4-7
P5KE120A		P6KE150A	4-7
P5KE120CA		P6KE150CA	4-7
P5KE12A		P6KE15A	4-7
P5KE12CA		P6KE15CA	4-7
P5KE130A		P6KE160	4-7
P5KE130CA		P6KE160CA	4-7
P5KE13A		P6KE15A	4-7
P5KE13CA		P6KE15CA	4-7
P5KE14A		P6KE18A	4-7
P5KE14CA		P6KE18CA	4-7
P5KE150A		P6KE180A	4-7
P5KE150CA		P6KE180CA	4-7
P5KE15A		P6KE18A	4-7
P5KE15CA		P6KE18CA	4-7
P5KE160A		P6KE200A	4-7
P5KE160CA		P6KE200CA	4-7
P5KE16A		P6KE20A	4-7
P5KE16CA		P6KE20CA	4-7
P5KE170A		P6KE200A	4-7
P5KE170CA		P6KE200CA	4-7
P5KE17A		P6KE20A	4-7
P5KE17CA		P6KE20CA	4-7
P5KE18A		P6KE22A	4-7
P5KE18CA		P6KE22CA	4-7
P5KE20A		P6KE24A	4-7
P5KE20CA		P6KE24CA	4-7
P5KE22A		P6KE27A	4-7
P5KE22CA		P6KE27CA	4-7
P5KE24A		P6KE30A	4-7

CF = consult factory representative

**CROSS-REFERENCE (continued)**

Industry Part Number	Motorola Direct Replacement	Motorola Similar Replacement	Page Number
P5KE24CA		P6KE30CA	4-7
P5KE26A		P6KE33A	4-7
P5KE26CA		P6KE33CA	4-7
P5KE28A		P6KE33A	4-7
P5KE28CA		P6KE33CA	4-7
P5KE30A		P6KE36A	4-7
P5KE30CA		P6KE36CA	4-7
P5KE33A		P6KE39A	4-7
P5KE33CA		P6KE39CA	4-7
P5KE36A		P6KE43A	4-7
P5KE36CA		P6KE43CA	4-7
P5KE40A		P6KE47A	4-7
P5KE40CA		P6KE47CA	4-7
P5KE43A		P6KE51A	4-7
P5KE43CA		P6KE51CA	4-7
P5KE45A		P6KE56A	4-7
P5KE45CA		P6KE56CA	4-7
P5KE48A		P6KE56A	4-7
P5KE48CA		P6KE56CA	4-7
P5KE5.0A		P6KE6.8A	4-7
P5KE5.0CA		P6KE6.8CA	4-7
P5KE51A		P6KE62A	4-7
P5KE51CA		P6KE62CA	4-7
P5KE54A		P6KE68A	4-7
P5KE54CA		P6KE68CA	4-7
P5KE58A		P6KE68A	4-7
P5KE58CA		P6KE68CA	4-7
P5KE6.0A		P6KE7.5A	4-7
P5KE6.0CA		P6KE7.5CA	4-7
P5KE6.5A		P6KE7.5A	4-7
P5KE6.5CA		P6KE7.5CA	4-7
P5KE60A		P6KE75A	4-7
P5KE60CA		P6KE75CA	4-7
P5KE64A		P6KE75A	4-7
P5KE64CA		P6KE75CA	4-7
P5KE7.0A		P6KE8.2A	4-7
P5KE7.0CA		P6KE8.2CA	4-7
P5KE7.5A		P6KE9.1A	4-7
P5KE7.5CA		P6KE9.1CA	4-7
P5KE70A		P6KE82A	4-7
P5KE70CA		P6KE82CA	4-7
P5KE75A		P6KE91A	4-7
P5KE75CA		P6KE91CA	4-7
P5KE78A		P6KE91A	4-7
P5KE78CA		P6KE91CA	4-7
P5KE8.0A		P6KE10A	4-7
P5KE8.0CA		P6KE10CA	4-7
P5KE8.5A		P6KE10A	4-7
P5KE8.5CA		P6KE10CA	4-7
P5KE85A		P6KE100A	4-7

Industry Part Number	Motorola Direct Replacement	Motorola Similar Replacement	Page Number
P5KE85CA		P6KE100CA	4-7
P5KE9.0A		P6KE11A	4-7
P5KE9.0CA		P6KE11CA	4-7
P5KE90A		P6KE110A	4-7
P5KE90CA		P6KE110CA	4-7
P6KE10	P6KE10A		4-7
P6KE100	P6KE100A		4-7
P6KE100A	P6KE100A		4-7
P6KE100C	P6KE100CA		4-7
P6KE100CA	P6KE100CA		4-7
P6KE100CP		P6KE100CA	4-7
P6KE100P		P6KE100A	4-7
P6KE10A	P6KE10A		4-7
P6KE10C	P6KE10CA		4-7
P6KE10CA	P6KE10CA		4-7
P6KE10CP		P6KE10CA	4-7
P6KE10P		P6KE10A	4-7
P6KE11	P6KE11A		4-7
P6KE110	P6KE110A		4-7
P6KE110A	P6KE110A		4-7
P6KE110C	P6KE110CA		4-7
P6KE110CA	P6KE110CA		4-7
P6KE110CP		P6KE110CA	4-7
P6KE110P		P6KE110A	4-7
P6KE11A	P6KE11A		4-7
P6KE11C	P6KE11CA		4-7
P6KE11CA	P6KE11CA		4-7
P6KE11CP		P6KE11CA	4-7
P6KE11P		P6KE11A	4-7
P6KE12	P6KE12A		4-7
P6KE120	P6KE120A		4-7
P6KE120A	P6KE120A		4-7
P6KE120C	P6KE120CA		4-7
P6KE120CA	P6KE120CA		4-7
P6KE120CP		P6KE120CA	4-7
P6KE120P		P6KE120A	4-7
P6KE12A	P6KE12A		4-7
P6KE12C	P6KE12CA		4-7
P6KE12CA	P6KE12CA		4-7
P6KE12CP		P6KE12CA	4-7
P6KE12P		P6KE12A	4-7
P6KE13	P6KE13A		4-7
P6KE130	P6KE130A		4-7
P6KE130A	P6KE130A		4-7
P6KE130C	P6KE130CA		4-7
P6KE130CA	P6KE130CA		4-7
P6KE130CP		P6KE130CA	4-7
P6KE130P		P6KE130A	4-7
P6KE13A	P6KE13A		4-7
P6KE13C	P6KE13CA		4-7

CF = consult factory representative

**CROSS-REFERENCE (continued)**

Industry Part Number	Motorola Direct Replacement	Motorola Similar Replacement	Page Number
P6KE13CA	P6KE13CA		4-7
P6KE13CP		P6KE13CA	4-7
P6KE13P		P6KE13A	4-7
P6KE15	P6KE15A		4-7
P6KE150	P6KE150A		4-7
P6KE150A	P6KE150A		4-7
P6KE150C	P6KE150CA		4-7
P6KE150CA	P6KE150CA		4-7
P6KE150CP		P6KE150CA	4-7
P6KE150P		P6KE150A	4-7
P6KE15A	P6KE15A		4-7
P6KE15C	P6KE15CA		4-7
P6KE15CA	P6KE15CA		4-7
P6KE15CP		P6KE15CA	4-7
P6KE15P		P6KE15A	4-7
P6KE16	P6KE16A		4-7
P6KE160	P6KE160A		4-7
P6KE160A	P6KE160A		4-7
P6KE160C	P6KE160CA		4-7
P6KE160CA	P6KE160CA		4-7
P6KE160CP		P6KE160CA	4-7
P6KE160P		P6KE160A	4-7
P6KE16A	P6KE16A		4-7
P6KE16C	P6KE16CA		4-7
P6KE16CA	P6KE16CA		4-7
P6KE16CP		P6KE16CA	4-7
P6KE16P		P6KE16A	4-7
P6KE170	P6KE170A		4-7
P6KE170A	P6KE170A		4-7
P6KE170C	P6KE170CA		4-7
P6KE170CA	P6KE170CA		4-7
P6KE170CP		P6KE170CA	4-7
P6KE170P		P6KE170A	4-7
P6KE18	P6KE18A		4-7
P6KE180	P6KE180A		4-7
P6KE180A	P6KE180A		4-7
P6KE180C	P6KE180CA		4-7
P6KE180CA	P6KE180CA		4-7
P6KE180CP		P6KE180CA	4-7
P6KE180P		P6KE180A	4-7
P6KE18A	P6KE18A		4-7
P6KE18C	P6KE18CA		4-7
P6KE18CA	P6KE18CA		4-7
P6KE18CP		P6KE18CA	4-7
P6KE18P		P6KE18A	4-7
P6KE20	P6KE20A		4-7
P6KE200	P6KE200A		4-7
P6KE200A	P6KE200A		4-7
P6KE200C	P6KE200CA		4-7
P6KE200CA	P6KE200CA		4-7

Industry Part Number	Motorola Direct Replacement	Motorola Similar Replacement	Page Number
P6KE200CP		P6KE200CA	4-7
P6KE200P		P6KE200A	4-7
P6KE20A	P6KE20A		4-7
P6KE20C	P6KE20CA		4-7
P6KE20CA	P6KE20CA		4-7
P6KE20CP		P6KE20CA	4-7
P6KE20P		P6KE20A	4-7
P6KE22	P6KE22A		4-7
P6KE220CP		1.5KE220CA	4-17
P6KE220P		1.5KE220A	4-17
P6KE22A	P6KE22A		4-7
P6KE22C	P6KE22CA		4-7
P6KE22CA	P6KE22CA		4-7
P6KE22CP		P6KE22CA	4-7
P6KE22P		P6KE22A	4-7
P6KE24	P6KE24A		4-7
P6KE24A	P6KE24A		4-7
P6KE24C	P6KE24CA		4-7
P6KE24CA	P6KE24CA		4-7
P6KE24CP		P6KE24CA	4-7
P6KE24P		P6KE24A	4-7
P6KE250CP		1.5KE250CA	4-17
P6KE250P		1.5KE250A	4-17
P6KE27	P6KE27A		4-7
P6KE27A	P6KE27A		4-7
P6KE27C	P6KE27CA		4-7
P6KE27CA	P6KE27CA		4-7
P6KE27CP		P6KE27CA	4-7
P6KE27P		P6KE27A	4-7
P6KE30	P6KE30A		4-7
P6KE30A	P6KE30A		4-7
P6KE30C	P6KE30CA		4-7
P6KE30CA	P6KE30CA		4-7
P6KE30CP		P6KE30CA	4-7
P6KE30P		P6KE30A	4-7
P6KE33	P6KE33A		4-7
P6KE33A	P6KE33A		4-7
P6KE33C	P6KE33C		4-7
P6KE33CA	P6KE33CA		4-7
P6KE33CP		P6KE33CA	4-7
P6KE33P		P6KE33A	4-7
P6KE36	P6KE36A		4-7
P6KE36A	P6KE36A		4-7
P6KE36C	P6KE36CA		4-7
P6KE36CA	P6KE36CA		4-7
P6KE36CP		P6KE36CA	4-7
P6KE36P		P6KE36A	4-7
P6KE39	P6KE39A		4-7
P6KE39A	P6KE39A		4-7
P6KE39C	P6KE39CA		4-7

CF = consult factory representative

**CROSS-REFERENCE (continued)**

Industry Part Number	Motorola Direct Replacement	Motorola Similar Replacement	Page Number
P6KE39CA	P6KE39CA		4-7
P6KE39CP		P6KE39CA	4-7
P6KE39P		P6KE39A	4-7
P6KE43	P6KE43A		4-7
P6KE43A	P6KE43A		4-7
P6KE43C	P6KE43CA		4-7
P6KE43CA	P6KE43CA		4-7
P6KE43CP		P6KE43CA	4-7
P6KE43P		P6KE43A	4-7
P6KE47	P6KE47A		4-7
P6KE47A	P6KE47A		4-7
P6KE47C	P6KE47CA		4-7
P6KE47CA	P6KE47CA		4-7
P6KE47CP		P6KE47CA	4-7
P6KE47P		P6KE47A	4-7
P6KE51	P6KE51A		4-7
P6KE51A	P6KE51A		4-7
P6KE51C	P6KE51CA		4-7
P6KE51CA	P6KE51CA		4-7
P6KE51CP		P6KE51CA	4-7
P6KE51P		P6KE51A	4-7
P6KE56	P6KE56A		4-7
P6KE56A	P6KE56A		4-7
P6KE56C	P6KE56CA		4-7
P6KE56CA	P6KE56CA		4-7
P6KE56CP		P6KE56CA	4-7
P6KE56P		P6KE56A	4-7
P6KE6.8	P6KE6.8A		4-7
P6KE6.8A	P6KE6.8A		4-7
P6KE6.8C	P6KE6.8CA		4-7
P6KE6.8CA	P6KE6.8CA		4-7
P6KE62	P6KE62A		4-7
P6KE62A	P6KE62A		4-7
P6KE62C	P6KE62CA		4-7
P6KE62CA	P6KE62CA		4-7
P6KE62CP		P6KE62CA	4-7
P6KE62P		P6KE62A	4-7
P6KE68	P6KE68A		4-7
P6KE68A	P6KE68A		4-7
P6KE68C	P6KE68CA		4-7
P6KE68CA	P6KE68CA		4-7
P6KE68CP		P6KE68CA	4-7
P6KE68P		P6KE68A	4-7
P6KE6V8A		P6KE6.8A	4-7
P6KE6V8CA		P6KE6.8CA	4-7
P6KE6V8CP		P6KE6.8CA	4-7
P6KE6V8P		P6KE6.8A	4-7
P6KE7.5	P6KE7.5A		4-7
P6KE7.5A	P6KE7.5A		4-7
P6KE7.5C	P6KE7.5CA		4-7

Industry Part Number	Motorola Direct Replacement	Motorola Similar Replacement	Page Number
P6KE7.5CA	P6KE7.5CA		4-7
P6KE75	P6KE75A		4-7
P6KE75A	P6KE75A		4-7
P6KE75C	P6KE75CA		4-7
P6KE75CA	P6KE75CA		4-7
P6KE75CP		P6KE75CA	4-7
P6KE75P		P6KE75A	4-7
P6KE7V5A		P6KE7.5A	4-7
P6KE7V5CA		P6KE7.5CA	4-7
P6KE7V5CP		P6KE7.5CA	4-7
P6KE7V5P		P6KE7.5A	4-7
P6KE8.2	P6KE8.2A		4-7
P6KE8.2A	P6KE8.2A		4-7
P6KE8.2C	P6KE8.2CA		4-7
P6KE8.2CA	P6KE8.2CA		4-7
P6KE82	P6KE82A		4-7
P6KE82A	P6KE82A		4-7
P6KE82C	P6KE82CA		4-7
P6KE82CA	P6KE82CA		4-7
P6KE82CP		P6KE82CA	4-7
P6KE82P		P6KE82A	4-7
P6KE8V2A		P6KE8.2A	4-7
P6KE8V2CA		P6KE8.2CA	4-7
P6KE8V2CP		P6KE8.2CA	4-7
P6KE8V2P		P6KE8.2A	4-7
P6KE9.1	P6KE9.1A		4-7
P6KE9.1A	P6KE9.1A		4-7
P6KE9.1C	P6KE9.1CA		4-7
P6KE9.1CA	P6KE9.1CA		4-7
P6KE91	P6KE91A		4-7
P6KE91A	P6KE91A		4-7
P6KE91C	P6KE91CA		4-7
P6KE91CA	P6KE91CA		4-7
P6KE91CP		P6KE91CA	4-7
P6KE91P		P6KE91A	4-7
P6KE9V1A		P6KE9.1A	4-7
P6KE9V1CA		P6KE9.1CA	4-7
P6KE9V1CP		P6KE9.1CA	4-7
P6KE9V1P		P6KE9.1A	4-7
P6SMB100AT3	P6SMB100AT3		5-16
P6SMB10AT3	P6SMB10AT3		5-16
P6SMB110AT3	P6SMB110AT3		5-16
P6SMB11AT3	P6SMB11AT3		5-16
P6SMB120AT3	P6SMB120AT3		5-16
P6SMB12AT3	P6SMB12AT3		5-16
P6SMB130AT3	P6SMB130AT3		5-16
P6SMB13AT3	P6SMB13AT3		5-16
P6SMB150AT3	P6SMB150AT3		5-16
P6SMB15AT3	P6SMB15AT3		5-16
P6SMB160AT3	P6SMB160AT3		5-16

CF = consult factory representative



**CROSS-REFERENCE (continued)**

Industry Part Number	Motorola Direct Replacement	Motorola Similar Replacement	Page Number
P6SMB16AT3	P6SMB16AT3		5-16
P6SMB170AT3	P6SMB170AT3		5-16
P6SMB180AT3	P6SMB180AT3		5-16
P6SMB18AT3	P6SMB18AT3		5-16
P6SMB200AT3	P6SMB200AT3		5-16
P6SMB20AT3	P6SMB20AT3		5-16
P6SMB22AT3	P6SMB22AT3		5-16
P6SMB24AT3	P6SMB24AT3		5-16
P6SMB27AT3	P6SMB27AT3		5-16
P6SMB30AT3	P6SMB30AT3		5-16
P6SMB33AT3	P6SMB33AT3		5-16
P6SMB36AT3	P6SMB36AT3		5-16
P6SMB39AT3	P6SMB39AT3		5-16
P6SMB43AT3	P6SMB43AT3		5-16
P6SMB47AT3	P6SMB47AT3		5-16
P6SMB51AT3	P6SMB51AT3		5-16
P6SMB56AT3	P6SMB56AT3		5-16
P6SMB6.8AT3	P6SMB6.8AT3		5-16
P6SMB62AT3	P6SMB62AT3		5-16
P6SMB68AT3	P6SMB68AT3		5-16
P6SMB7.5AT3	P6SMB7.5AT3		5-16
P6SMB75AT3	P6SMB75AT3		5-16
P6SMB8.2AT3	P6SMB8.2AT3		5-16
P6SMB82AT3	P6SMB82AT3		5-16
P6SMB9.1AT3	P6SMB9.1AT3		5-16
P6SMB91AT3	P6SMB91AT3		5-16
P7KE10		1N6275A	4-17
P7KE100		1N6299A	4-17
P7KE100C		1.5KE150CA	4-17
P7KE10C		1.5KE15CA	4-17
P7KE25		1N6284A	4-17
P7KE25C		1.5KE36CA	4-17
P7KE43		1N6289A	4-17
P7KE43C		1.5KE56CA	4-17
P7T-10		1N6276A	4-17
P7T-10B		1.5KE16CA	4-17
P7T-110		1N6299A	4-17
P7T-110B		1.5KE150CA	4-17
P7T-27		1N6283A	4-17
P7T-27B		1.5KE33CA	4-17
P7T-43		1N6290A	4-17
P7T-43B		1.5KE62CA	4-17
PF8Z10		1N6271A	4-17
PF8Z100		1N6295A	4-17
PF8Z12		1N6273A	4-17
PF8Z120		1N6297A	4-17
PF8Z15		1N6275A	4-17
PF8Z150		1N6299A	4-17
PF8Z18		1N6277A	4-17
PF8Z180		1N6302A	4-17

Industry Part Number	Motorola Direct Replacement	Motorola Similar Replacement	Page Number
PF8Z22		1N6279A	4-17
PF8Z27		1N6281A	4-17
PF8Z33		1N6283A	4-17
PF8Z39		1N6285A	4-17
PF8Z47		1N6287A	4-17
PF8Z56		1N6289A	4-17
PF8Z62		1N6290A	4-17
PF8Z68		1N6291A	4-17
PF8Z6V8		1N6267A	4-17
PF8Z82		1N6293A	4-17
PF8Z8V2		1N6269A	4-17
PFZ10		1N6271A	4-17
PFZ100		1N6295A	4-17
PFZ100A		1N6295A	4-17
PFZ10A		1N6271A	4-17
PFZ11		1N6272A	4-17
PFZ110		1N6296A	4-17
PFZ110A		1N6296A	4-17
PFZ11A		1N6272A	4-17
PFZ12		1N6273A	4-17
PFZ120		1N6297A	4-17
PFZ120A		1N6297A	4-17
PFZ12A		1N6273A	4-17
PFZ13		1N6274A	4-17
PFZ130		1N6298A	4-17
PFZ130A		1N6298A	4-17
PFZ13A		1N6274A	4-17
PFZ15		1N6275A	4-17
PFZ150		1N6299A	4-17
PFZ150A		1N6299A	4-17
PFZ15A		1N6275A	4-17
PFZ16		1N6276A	4-17
PFZ160		1N6300A	4-17
PFZ160A		1N6300A	4-17
PFZ16A		1N6276A	4-17
PFZ170		1N6301A	4-17
PFZ170A		1N6301A	4-17
PFZ18		1N6277A	4-17
PFZ180		1N6302A	4-17
PFZ180A		1N6302A	4-17
PFZ18A		1N6277A	4-17
PFZ20		1N6278A	4-17
PFZ200		1N6303A	4-17
PFZ200A		1N6303A	4-17
PFZ20A		1N6278A	4-17
PFZ22		1N6279A	4-17
PFZ220		1.5KE220A	4-17
PFZ220A		1.5KE220A	4-17
PFZ22A		1N6279A	4-17
PFZ24		1N6280A	4-17

CF = consult factory representative

**CROSS-REFERENCE (continued)**

Industry Part Number	Motorola Direct Replacement	Motorola Similar Replacement	Page Number
PFZ24A		1N6280A	4-17
PFZ250		1.5KE250A	4-17
PFZ250A		1.5KE250A	4-17
PFZ27		1N6281A	4-17
PFZ27A		1N6281A	4-17
PFZ30		1N6282A	4-17
PFZ30A		1N6282A	4-17
PFZ33		1N6283A	4-17
PFZ33A		1N6283A	4-17
PFZ36		1N6284A	4-17
PFZ36A		1N6284A	4-17
PFZ39		1N6285A	4-17
PFZ39A		1N6285A	4-17
PFZ43		1N6286A	4-17
PFZ43A		1N6286A	4-17
PFZ47		1N6287A	4-17
PFZ47A		1N6287A	4-17
PFZ51		1N6288A	4-17
PFZ51A		1N6288A	4-17
PFZ56		1N6289A	4-17
PFZ56A		1N6289A	4-17
PFZ62		1N6290A	4-17
PFZ62A		1N6290A	4-17
PFZ68		1N6291A	4-17
PFZ68A		1N6291A	4-17
PFZ6V8		1N6267A	4-17
PFZ6V8A		1N6267A	4-17
PFZ75		1N6292A	4-17
PFZ75A		1N6292A	4-17
PFZ7V5		1N6268A	4-17
PFZ7V5A		1N6268A	4-17
PFZ82		1N6293A	4-17
PFZ82A		1N6293A	4-17
PFZ8V2		1N6269A	4-17
PFZ8V2A		1N6269A	4-17
PFZ91		1N6294A	4-17
PFZ91A		1N6294A	4-17
PFZ9V1		1N6270A	4-17
PFZ9V1A		1N6270A	4-17
PFZD10		1.5KE10CA	4-17
PFZD100		1.5KE100CA	4-17
PFZD12		1.5KE12CA	4-17
PFZD120		1.5KE120CA	4-17
PFZD15		1.5KE15CA	4-17
PFZD150		1.5KE150CA	4-17
PFZD18		1.5KE18CA	4-17
PFZD180		1.5KE180CA	4-17
PFZD22		1.5KE22CA	4-17
PFZD27		1.5KE27CA	4-17
PFZD33		1.5KE33CA	4-17

Industry Part Number	Motorola Direct Replacement	Motorola Similar Replacement	Page Number
PFZD39		1.5KE39CA	4-17
PFZD47		1.5KE47CA	4-17
PFZD56		1.5KE56CA	4-17
PFZD62		1.5KE62CA	4-17
PFZD68		1.5KE68CA	4-17
PFZD6V8		1.5KE6.8CA	4-17
PFZD82		1.5KE82CA	4-17
PFZD8V2		1.5KE8.2CA	4-17
PZD16		1.5KE16CA	4-17
PZD160		1.5KE160CA	4-17
PZD36		1.5KE36CA	4-17
PZD62		1.5KE62CA	4-17
SA10	SA10A		4-3
SA100	SA100A		4-3
SA100A	SA100A		4-3
SA100C	SA100CA		4-3
SA100CA	SA100CA		4-3
SA10A	SA10A		4-3
SA10C	SA10CA		4-3
SA10CA	SA10CA		4-3
SA11	SA11A		4-3
SA110	SA110A		4-3
SA110A	SA110A		4-3
SA110C	SA110CA		4-3
SA110CA	SA110CA		4-3
SA11A	SA11A		4-3
SA11C	SA11C		4-3
SA11CA	SA11CA		4-3
SA12	SA12A		4-3
SA120	SA120A		4-3
SA120A	SA120A		4-3
SA120C	SA120CA		4-3
SA120CA	SA120CA		4-3
SA12A	SA12A		4-3
SA12C	SA12CA		4-3
SA12CA	SA12CA		4-3
SA13	SA13A		4-3
SA130	SA130A		4-3
SA130A	SA130A		4-3
SA130C	SA130CA		4-3
SA130CA	SA130CA		4-3
SA13A	SA13A		4-3
SA13C	SA13CA		4-3
SA13CA	SA13CA		4-3
SA14	SA14A		4-3
SA14A	SA14A		4-3
SA14C	SA14CA		4-3
SA14CA	SA14CA		4-3
SA15	SA15A		4-3
SA150	SA150A		4-3

CF = consult factory representative

**CROSS-REFERENCE (continued)**

Industry Part Number	Motorola Direct Replacement	Motorola Similar Replacement	Page Number
SA150A	SA150A		4-3
SA150C	SA150CA		4-3
SA150CA	SA150CA		4-3
SA15A	SA15A		4-3
SA15C	SA15CA		4-3
SA15CA	SA15CA		4-3
SA16	SA16A		4-3
SA160	SA160A		4-3
SA160A	SA160A		4-3
SA160C	SA160CA		4-3
SA160CA	SA160CA		4-3
SA16A	SA16A		4-3
SA16C	SA16CA		4-3
SA16CA	SA16CA		4-3
SA17	SA17A		4-3
SA170	SA170A		4-3
SA170A	SA170A		4-3
SA170C	SA170CA		4-3
SA170CA	SA170CA		4-3
SA17A	SA17A		4-3
SA17C	SA17CA		4-3
SA17CA	SA17CA		4-3
SA18	SA18A		4-3
SA18A	SA18A		4-3
SA18C	SA18CA		4-3
SA18CA	SA18CA		4-3
SA20	SA20A		4-3
SA20A	SA20A		4-3
SA20C	SA20CA		4-3
SA20CA	SA20CA		4-3
SA22	SA22A		4-3
SA22A	SA22A		4-3
SA22C	SA22CA		4-3
SA22CA	SA22CA		4-3
SA24	SA24A		4-3
SA24A	SA24A		4-3
SA24C	SA24CA		4-3
SA24CA	SA24CA		4-3
SA26	SA26A		4-3
SA26A	SA26A		4-3
SA26C	SA26CA		4-3
SA26CA	SA26CA		4-3
SA28	SA28A		4-3
SA28A	SA28A		4-3
SA28C	SA28CA		4-3
SA28CA	SA28CA		4-3
SA30	SA30A		4-3
SA30A	SA30A		4-3
SA30C	SA30CA		4-3
SA30CA	SA30CA		4-3

Industry Part Number	Motorola Direct Replacement	Motorola Similar Replacement	Page Number
SA33	SA33A		4-3
SA33A	SA33A		4-3
SA33C	SA33CA		4-3
SA33CA	SA33CA		4-3
SA36	SA36A		4-3
SA36A	SA36A		4-3
SA36C	SA36CA		4-3
SA36CA	SA36CA		4-3
SA40	SA40A		4-3
SA40A	SA40A		4-3
SA40C	SA40CA		4-3
SA40CA	SA40CA		4-3
SA43	SA43A		4-3
SA43A	SA43A		4-3
SA43C	SA43CA		4-3
SA43CA	SA43CA		4-3
SA45	SA45A		4-3
SA45A	SA45A		4-3
SA45C	SA45CA		4-3
SA45CA	SA45CA		4-3
SA48	SA48A		4-3
SA48A	SA48A		4-3
SA48C	SA48CA		4-3
SA48CA	SA48CA		4-3
SA5.0	SA5.0A		4-3
SA5.0A	SA5.0A		4-3
SA5.0C	-		CF
SA5.0CA	-		CF
SA51	SA51A		4-3
SA51A	SA51A		4-3
SA51C	SA51CA		4-3
SA51CA	SA51CA		4-3
SA54	SA54A		4-3
SA54A	SA54A		4-3
SA54C	SA54CA		4-3
SA54CA	SA54CA		4-3
SA58	SA58A		4-3
SA58A	SA58A		4-3
SA58C	SA58CA		4-3
SA58CA	SA58CA		4-3
SA6.0	SA6.0A		4-3
SA6.0A	SA6.0A		4-3
SA6.0C	SA6.0CA		4-3
SA6.0CA	SA6.0CA		4-3
SA6.5	SA6.5A		4-3
SA6.5A	SA6.5A		4-3
SA6.5C	SA6.5CA		4-3
SA6.5CA	SA6.5CA		4-3
SA60	SA60A		4-3
SA60A	SA60A		4-3

CF = consult factory representative

**CROSS-REFERENCE (continued)**

Industry Part Number	Motorola Direct Replacement	Motorola Similar Replacement	Page Number
SA60C	SA60CA		4-3
SA60CA	SA60CA		4-3
SA64	SA64A		4-3
SA64A	SA64A		4-3
SA64C	SA64CA		4-3
SA64CA	SA64CA		4-3
SA7.0	SA7.0A		4-3
SA7.0A	SA7.0A		4-3
SA7.0C	SA7.0CA		4-3
SA7.0CA	SA7.0CA		4-3
SA7.5	SA7.5A		4-3
SA7.5A	SA7.5A		4-3
SA7.5C	SA7.5CA		4-3
SA7.5CA	SA7.5CA		4-3
SA70	SA70A		4-3
SA70A	SA70A		4-3
SA70C	SA70CA		4-3
SA70CA	SA70CA		4-3
SA75	SA75A		4-3
SA75A	SA75A		4-3
SA75C	SA75CA		4-3
SA75CA	SA75CA		4-3
SA78	SA78A		4-3
SA78A	SA78A		4-3
SA78C	SA78CA		4-3
SA78CA	SA78CA		4-3
SA8.0	SA8.0A		4-3
SA8.0A	SA8.0A		4-3
SA8.0C	SA8.0CA		4-3
SA8.0CA	SA8.0CA		4-3
SA8.5	SA8.5A		4-3
SA8.5A	SA8.5A		4-3
SA8.5C	SA8.5CA		4-3
SA8.5CA	SA8.5CA		4-3
SA85	SA85A		4-3
SA85A	SA85A		4-3
SA85C	SA85CA		4-3
SA85CA	SA85CA		4-3
SA9.0	SA9.0A		4-3
SA9.0A	SA9.0A		4-3
SA9.0C	SA9.0CA		4-3
SA9.0CA	SA9.0CA		4-3
SA90	SA90A		4-3
SA90A	SA90A		4-3
SA90C	SA90CA		4-3
SA90CA	SA90CA		4-3
SAB10		SA10A	4-3
SAB12		SA12A	4-3
SAB15		SA15A	4-3
SAB18		SA18A	4-3

Industry Part Number	Motorola Direct Replacement	Motorola Similar Replacement	Page Number
SAB24		SA24A	4-3
SAB28		SA28A	4-3
SAB5.0		SA5.0A	4-3
SBL10		1N6276A	4-17
SBL100		1N6299A	4-17
SBL100C		1.5KE150CA	4-17
SBL10C		1.5KE16CA	4-17
SBL25		1N6284A	4-17
SBL25C		1.5KE36CA	4-17
SBL43		1N6290A	4-17
SBL43C		1.5KE62CA	4-17
SM15T10		1.5SMC10AT3	5-23
SM15T10A		1.5SMC10AT3	5-23
SM15T12		1.5SMC12AT3	5-23
SM15T12A		1.5SMC12AT3	5-23
SM15T15		1.5SMC15AT3	5-23
SM15T15A		1.5SMC15AT3	5-23
SM15T18		1.5SMC18AT3	5-23
SM15T18A		1.5SMC18AT3	5-23
SM15T22		1.5SMC22AT3	5-23
SM15T22A		1.5SMC22AT3	5-23
SM15T24		1.5SMC24AT3	5-23
SM15T24A		1.5SMC24AT3	5-23
SM15T27		1.5SMC27AT3	5-23
SM15T27A		1.5SMC27AT3	5-23
SM15T30		1.5SMC30AT3	5-23
SM15T30A		1.5SMC30AT3	5-23
SM15T33		1.5SMC33AT3	5-23
SM15T33A		1.5SMC33AT3	5-23
SM15T36		1.5SMC36AT3	5-23
SM15T36A		1.5SMC36AT3	5-23
SM15T39		1.5SMC39AT3	5-23
SM15T39A		1.5SMC39AT3	5-23
SM15T68		1.5SMC68AT3	5-23
SM15T68A		1.5SMC68AT3	5-23
SM15T6V8		1.5SMC6.8AT3	5-23
SM15T6V8A		1.5SMC6.8AT3	5-23
SM15T7V5		1.5SMC7.5AT3	5-23
SM15T7V5A		1.5SMC7.5AT3	5-23
SM4T10		P6SMB10AT3	5-16
SM4T100		P6SMB100AT3	5-16
SM4T100A		P6SMB100AT3	5-16
SM4T10A		P6SMB10AT3	5-16
SM4T12		P6SMB12AT3	5-16
SM4T12A		P6SMB12AT3	5-16
SM4T15		P6SMB15AT3	5-16
SM4T150		P6SMB150AT3	5-16
SM4T150A		P6SMB150AT3	5-16
SM4T15A		P6SMB15AT3	5-16
SM4T18		P6SMB18AT3	5-16

CF = consult factory representative

**CROSS-REFERENCE (continued)**

Industry Part Number	Motorola Direct Replacement	Motorola Similar Replacement	Page Number
SM4T18A		P6SMB18AT3	5-16
SM4T200		P6SMB200AT3	5-16
SM4T200A		P6SMB200AT3	5-16
SM4T22		P6SMB22AT3	5-16
SM4T22A		P6SMB22AT3	5-16
SM4T24		P6SMB24AT3	5-16
SM4T24A		P6SMB24AT3	5-16
SM4T27		P6SMB27AT3	5-16
SM4T27A		P6SMB27AT3	5-16
SM4T30		P6SMB30AT3	5-16
SM4T30A		P6SMB30AT3	5-16
SM4T33		P6SMB33AT3	5-16
SM4T33A		P6SMB33AT3	5-16
SM4T36		P6SMB36AT3	5-16
SM4T36A		P6SMB36AT3	5-16
SM4T39		P6SMB39AT3	5-16
SM4T39A		P6SMB39AT3	5-16
SM4T68		P6SMB68AT3	5-16
SM4T68A		P6SMB68AT3	5-16
SM4T6V8		P6SMB6.8AT3	5-16
SM4T6V8A		P6SMB6.8AT3	5-16
SM4T7V5		P6SMB7.5AT3	5-16
SM4T7V5A		P6SMB7.5AT3	5-16
SM6T10		P6SMB10AT3	5-16
SM6T100		P6SMB100AT3	5-16
SM6T100A		P6SMB100AT3	5-16
SM6T10A		P6SMB10AT3	5-16
SM6T12		P6SMB12AT3	5-16
SM6T12A		P6SMB12AT3	5-16
SM6T15		P6SMB15AT3	5-16
SM6T150		P6SMB150AT3	5-16
SM6T150A		P6SMB150AT3	5-16
SM6T15A		P6SMB15AT3	5-16
SM6T18		P6SMB18AT3	5-16
SM6T18A		P6SMB18AT3	5-16
SM6T200		P6SMB200AT3	5-16
SM6T200A		P6SMB200AT3	5-16
SM6T22		P6SMB22AT3	5-16
SM6T22A		P6SMB22AT3	5-16
SM6T24		P6SMB24AT3	5-16
SM6T24A		P6SMB24AT3	5-16
SM6T27		P6SMB27AT3	5-16
SM6T27A		P6SMB27AT3	5-16
SM6T30		P6SMB30AT3	5-16
SM6T30A		P6SMB30AT3	5-16
SM6T33		P6SMB33AT3	5-16
SM6T33A		P6SMB33AT3	5-16
SM6T36		P6SMB36AT3	5-16
SM6T36A		P6SMB36AT3	5-16
SM6T39		P6SMB39AT3	5-16

Industry Part Number	Motorola Direct Replacement	Motorola Similar Replacement	Page Number
SM6T39A		P6SMB39AT3	5-16
SM6T68		P6SMB68AT3	5-16
SM6T68A		P6SMB68AT3	5-16
SM6T6V8		P6SMB6.8AT3	5-16
SM6T6V8A		P6SMB6.8AT3	5-16
SM6T7V5		P6SMB7.5AT3	5-16
SM6T7V5A		P6SMB7.5AT3	5-16
SMBJ10	1SMB10AT3		5-14
SMBJ100	1SMB100AT3		5-14
SMBJ100A	1SMB100AT3		5-14
SMBJ10A	1SMB10AT3		5-14
SMBJ11	1SMB11AT3		5-14
SMBJ110	1SMB110AT3		5-14
SMBJ110A	1SMB110AT3		5-14
SMBJ11A	1SMB11AT3		5-14
SMBJ12	1SMB12AT3		5-14
SMBJ120	1SMB120AT3		5-14
SMBJ120A	1SMB120AT3		5-14
SMBJ12A	1SMB12AT3		5-14
SMBJ13	1SMB13AT3		5-14
SMBJ130	1SMB130AT3		5-14
SMBJ130A	1SMB130AT3		5-14
SMBJ13A	1SMB13AT3		5-14
SMBJ14	1SMB14AT3		5-14
SMBJ14A	1SMB14AT3		5-14
SMBJ15	1SMB15AT3		5-14
SMBJ150	1SMB150AT3		5-14
SMBJ150A	1SMB150AT3		5-14
SMBJ15A	1SMB15AT3		5-14
SMBJ16	1SMB16AT3		5-14
SMBJ160	1SMB160AT3		5-14
SMBJ160A	1SMB160AT3		5-14
SMBJ16A	1SMB16AT3		5-14
SMBJ17	1SMB17AT3		5-14
SMBJ170	1SMB170AT3		5-14
SMBJ170A	1SMB170AT3		5-14
SMBJ17A	1SMB17AT3		5-14
SMBJ18	1SMB18AT3		5-14
SMBJ18A	1SMB18AT3		5-14
SMBJ20	1SMB20AT3		5-14
SMBJ20A	1SMB20AT3		5-14
SMBJ22	1SMB22AT3		5-14
SMBJ22A	1SMB22AT3		5-14
SMBJ24	1SMB24AT3		5-14
SMBJ24A	1SMB24AT3		5-14
SMBJ26	1SMB26AT3		5-14
SMBJ26A	1SMB26AT3		5-14
SMBJ28	1SMB28AT3		5-14
SMBJ28A	1SMB28AT3		5-14
SMBJ30	1SMB30AT3		5-14

CF = consult factory representative

**CROSS-REFERENCE (continued)**

Industry Part Number	Motorola Direct Replacement	Motorola Similar Replacement	Page Number
SMBJ30A	1SMB30AT3		5-14
SMBJ33	1SMB33AT3		5-14
SMBJ33A	1SMB33AT3		5-14
SMBJ36	1SMB36AT3		5-14
SMBJ36A	1SMB36AT3		5-14
SMBJ40	1SMB40AT3		5-14
SMBJ40A	1SMB40AT3		5-14
SMBJ43	1SMB43AT3		5-14
SMBJ43A	1SMB43AT3		5-14
SMBJ45	1SMB45AT3		5-14
SMBJ45A	1SMB45AT3		5-14
SMBJ48	1SMB48AT3		5-14
SMBJ48A	1SMB48AT3		5-14
SMBJ5.0	1SMB5.0AT3		5-14
SMBJ5.0A	1SMB5.0AT3		5-14
SMBJ51	1SMB51AT3		5-14
SMBJ51A	1SMB51AT3		5-14
SMBJ54	1SMB54AT3		5-14
SMBJ54A	1SMB54AT3		5-14
SMBJ58	1SMB58AT3		5-14
SMBJ58A	1SMB58AT3		5-14
SMBJ6.0	1SMB6.0AT3		5-14
SMBJ6.0A	1SMB6.0AT3		5-14
SMBJ6.5	1SMB6.5AT3		5-14
SMBJ6.5A	1SMB6.5AT3		5-14
SMBJ60	1SMB60AT3		5-14
SMBJ60A	1SMB60AT3		5-14
SMBJ64	1SMB64AT3		5-14
SMBJ64A	1SMB64AT3		5-14
SMBJ7.0	1SMB7.0AT3		5-14
SMBJ7.0A	1SMB7.0AT3		5-14
SMBJ7.5	1SMB7.5AT3		5-14
SMBJ7.5A	1SMB7.5AT3		5-14
SMBJ70	1SMB70AT3		5-14
SMBJ70A	1SMB70AT3		5-14
SMBJ75	1SMB75AT3		5-14
SMBJ75A	1SMB75AT3		5-14
SMBJ78	1SMB78AT3		5-14
SMBJ78A	1SMB78AT3		5-14
SMBJ8.0	1SMB8.0AT3		5-14
SMBJ8.0A	1SMB8.0AT3		5-14
SMBJ8.5	1SMB8.5AT3		5-14
SMBJ8.5A	1SMB8.5AT3		5-14
SMBJ85	1SMB85AT3		5-14
SMBJ85A	1SMB85AT3		5-14
SMBJ9.0	1SMB9.0AT3		5-14
SMBJ9.0A	1SMB9.0AT3		5-14
SMBJ90	1SMB90AT3		5-14
SMBJ90A	1SMB90AT3		5-14
SMCJ10	1SMC10AT3		5-22

Industry Part Number	Motorola Direct Replacement	Motorola Similar Replacement	Page Number
SMCJ10A	1SMC10AT3		5-22
SMCJ11	1SMC11AT3		5-22
SMCJ11A	1SMC11AT3		5-22
SMCJ12	1SMC12AT3		5-22
SMCJ12A	1SMC12AT3		5-22
SMCJ13	1SMC13AT3		5-22
SMCJ13A	1SMC13AT3		5-22
SMCJ14	1SMC14AT3		5-22
SMCJ14A	1SMC14AT3		5-22
SMCJ15	1SMC15AT3		5-22
SMCJ15A	1SMC15AT3		5-22
SMCJ16	1SMC16AT3		5-22
SMCJ16A	1SMC16AT3		5-22
SMCJ17	1SMC17AT3		5-22
SMCJ17A	1SMC17AT3		5-22
SMCJ18	1SMC18AT3		5-22
SMCJ18A	1SMC18AT3		5-22
SMCJ20	1SMC20AT3		5-22
SMCJ20A	1SMC20AT3		5-22
SMCJ22	1SMC22AT3		5-22
SMCJ22A	1SMC22AT3		5-22
SMCJ24	1SMC24AT3		5-22
SMCJ24A	1SMC24AT3		5-22
SMCJ26	1SMC26AT3		5-22
SMCJ26A	1SMC26AT3		5-22
SMCJ28	1SMC28AT3		5-22
SMCJ28A	1SMC28AT3		5-22
SMCJ30	1SMC30AT3		5-22
SMCJ30A	1SMC30AT3		5-22
SMCJ33	1SMC33AT3		5-22
SMCJ33A	1SMC33AT3		5-22
SMCJ36	1SMC36AT3		5-22
SMCJ36A	1SMC36AT3		5-22
SMCJ40	1SMC40AT3		5-22
SMCJ40A	1SMC40AT3		5-22
SMCJ43	1SMC43AT3		5-22
SMCJ43A	1SMC43AT3		5-22
SMCJ45	1SMC45AT3		5-22
SMCJ45A	1SMC45AT3		5-22
SMCJ48	1SMC48AT3		5-22
SMCJ48A	1SMC48AT3		5-22
SMCJ5.0	1SMC5.0AT3		5-22
SMCJ5.0A	1SMC5.0AT3		5-22
SMCJ51	1SMC51AT3		5-22
SMCJ51A	1SMC51AT3		5-22
SMCJ54	1SMC54AT3		5-22
SMCJ54A	1SMC54AT3		5-22
SMCJ58	1SMC58AT3		5-22
SMCJ58A	1SMC58AT3		5-22
SMCJ6.0	1SMC6.0AT3		5-22

CF = consult factory representative

**CROSS-REFERENCE (continued)**

Industry Part Number	Motorola Direct Replacement	Motorola Similar Replacement	Page Number
SMCJ6.0A	1SMC6.0AT3		5-22
SMCJ6.5	1SMC6.5AT3		5-22
SMCJ6.5A	1SMC6.5AT3		5-22
SMCJ60	1SMC60AT3		5-22
SMCJ60A	1SMC60AT3		5-22
SMCJ64	1SMC64AT3		5-22
SMCJ64A	1SMC64AT3		5-22
SMCJ7.0	1SMC7.0AT3		5-22
SMCJ7.0A	1SMC7.0AT3		5-22
SMCJ7.5	1SMC7.5AT3		5-22
SMCJ7.5A	1SMC7.5AT3		5-22
SMCJ70	1SMC70AT3		5-22
SMCJ70A	1SMC70AT3		5-22
SMCJ75	1SMC75AT3		5-22
SMCJ75A	1SMC75AT3		5-22
SMCJ78	1SMC78AT3		5-22
SMCJ78A	1SMC78AT3		5-22
SMCJ8.0	1SMC8.0AT3		5-22
SMCJ8.0A	1SMC8.0AT3		5-22
SMCJ8.5	1SMC8.5AT3		5-22
SMCJ8.5A	1SMC8.5AT3		5-22
SMCJ9.0	1SMC9.0AT3		5-22
SMCJ9.0A	1SMC9.0AT3		5-22
SMMJ10		1SMC10AT3	5-22
SMMJ10A		1SMC10AT3	5-22
SMMJ11		1SMC11AT3	5-22
SMMJ11A		1SMC11AT3	5-22
SMMJ12		1SMC12AT3	5-22
SMMJ12A		1SMC12AT3	5-22
SMMJ13		1SMC13AT3	5-22
SMMJ13A		1SMC13AT3	5-22
SMMJ14		1SMC14AT3	5-22
SMMJ14A		1SMC14AT3	5-22
SMMJ15		1SMC15AT3	5-22
SMMJ15A		1SMC15AT3	5-22
SMMJ16		1SMC16AT3	5-22
SMMJ16A		1SMC16AT3	5-22
SMMJ17		1SMC17AT3	5-22
SMMJ17A		1SMC17AT3	5-22
SMMJ18		1SMC18AT3	5-22
SMMJ18A		1SMC18AT3	5-22
SMMJ20		1SMC20AT3	5-22
SMMJ20A		1SMC20AT3	5-22
SMMJ22		1SMC22AT3	5-22
SMMJ22A		1SMC22AT3	5-22
SMMJ24		1SMC24AT3	5-22
SMMJ24A		1SMC24AT3	5-22
SMMJ26		1SMC26AT3	5-22
SMMJ26A		1SMC26AT3	5-22
SMMJ28		1SMC28AT3	5-22

Industry Part Number	Motorola Direct Replacement	Motorola Similar Replacement	Page Number
SMMJ28A		1SMC28AT3	5-22
SMMJ30		1SMC30AT3	5-22
SMMJ30A		1SMC30AT3	5-22
SMMJ33		1SMC33AT3	5-22
SMMJ33A		1SMC33AT3	5-22
SMMJ36		1SMC36AT3	5-22
SMMJ36A		1SMC36AT3	5-22
SMMJ40		1SMC40AT3	5-22
SMMJ40A		1SMC40AT3	5-22
SMMJ43		1SMC43AT3	5-22
SMMJ43A		1SMC43AT3	5-22
SMMJ45		1SMC45AT3	5-22
SMMJ45A		1SMC45AT3	5-22
SMMJ48		1SMC48AT3	5-22
SMMJ48A		1SMC48AT3	5-22
SMMJ5.0		1SMC5.0AT3	5-22
SMMJ5.0A		1SMC5.0AT3	5-22
SMMJ51		1SMC51AT3	5-22
SMMJ51A		1SMC51AT3	5-22
SMMJ54		1SMC54AT3	5-22
SMMJ54A		1SMC54AT3	5-22
SMMJ58		1SMC58AT3	5-22
SMMJ58A		1SMC58AT3	5-22
SMMJ6.0		1SMC6.0AT3	5-22
SMMJ6.0A		1SMC6.0AT3	5-22
SMMJ6.5		1SMC6.5AT3	5-22
SMMJ6.5A		1SMC6.5AT3	5-22
SMMJ60		1SMC60AT3	5-22
SMMJ60A		1SMC60AT3	5-22
SMMJ64		1SMC64AT3	5-22
SMMJ64A		1SMC64AT3	5-22
SMMJ7.0		1SMC7.0AT3	5-22
SMMJ7.0A		1SMC7.0AT3	5-22
SMMJ7.5		1SMC7.5AT3	5-22
SMMJ7.5A		1SMC7.5AT3	5-22
SMMJ70		1SMC70AT3	5-22
SMMJ70A		1SMC70AT3	5-22
SMMJ75		1SMC75AT3	5-22
SMMJ75A		1SMC75AT3	5-22
SMMJ78		1SMC78AT3	5-22
SMMJ78A		1SMC78AT3	5-22
SMMJ8.0		1SMC8.0AT3	5-22
SMMJ8.0A		1SMC8.0AT3	5-22
SMMJ8.5		1SMC8.5AT3	5-22
SMMJ8.5A		1SMC8.5AT3	5-22
SMMJ9.0		1SMC9.0AT3	5-22
SMMJ9.0A		1SMC9.0AT3	5-22
SMSJ10		1SMB10AT3	5-14
SMSJ100		1SMB100AT3	5-14
SMSJ100A		1SMB100AT3	5-14

CF = consult factory representative

**CROSS-REFERENCE (continued)**

Industry Part Number	Motorola Direct Replacement	Motorola Similar Replacement	Page Number
SMSJ10A		1SMB10AT3	5-14
SMSJ11		1SMB11AT3	5-14
SMSJ110		1SMB110AT3	5-14
SMSJ110A		1SMB110AT3	5-14
SMSJ11A		1SMB11AT3	5-14
SMSJ12		1SMB12AT3	5-14
SMSJ120		1SMB120AT3	5-14
SMSJ120A		1SMB120AT3	5-14
SMSJ12A		1SMB12AT3	5-14
SMSJ13		1SMB13AT3	5-14
SMSJ130		1SMB130AT3	5-14
SMSJ130A		1SMB130AT3	5-14
SMSJ13A		1SMB13AT3	5-14
SMSJ14		1SMB14AT3	5-14
SMSJ14A		1SMB14AT3	5-14
SMSJ15		1SMB15AT3	5-14
SMSJ150		1SMB150AT3	5-14
SMSJ150A		1SMB150AT3	5-14
SMSJ15A		1SMB15AT3	5-14
SMSJ16		1SMB16AT3	5-14
SMSJ160		1SMB160AT3	5-14
SMSJ160A		1SMB160AT3	5-14
SMSJ16A		1SMB16AT3	5-14
SMSJ17		1SMB17AT3	5-14
SMSJ170		1SMB170AT3	5-14
SMSJ170A		1SMB170AT3	5-14
SMSJ17A		1SMB17AT3	5-14
SMSJ18		1SMB18AT3	5-14
SMSJ18A		1SMB18AT3	5-14
SMSJ20		1SMB20AT3	5-14
SMSJ20A		1SMB20AT3	5-14
SMSJ22		1SMB22AT3	5-14
SMSJ22A		1SMB22AT3	5-14
SMSJ24		1SMB24AT3	5-14
SMSJ24A		1SMB24AT3	5-14
SMSJ26		1SMB26AT3	5-14
SMSJ26A		1SMB26AT3	5-14
SMSJ28		1SMB28AT3	5-14
SMSJ28A		1SMB28AT3	5-14
SMSJ30		1SMB30AT3	5-14
SMSJ30A		1SMB30AT3	5-14
SMSJ33		1SMB33AT3	5-14
SMSJ33A		1SMB33AT3	5-14
SMSJ36		1SMB36AT3	5-14
SMSJ36A		1SMB36AT3	5-14
SMSJ40		1SMB40AT3	5-14
SMSJ40A		1SMB40AT3	5-14
SMSJ43		1SMB43AT3	5-14
SMSJ43A		1SMB43AT3	5-14
SMSJ45		1SMB45AT3	5-14

Industry Part Number	Motorola Direct Replacement	Motorola Similar Replacement	Page Number
SMSJ45A		1SMB45AT3	5-14
SMSJ48		1SMB48AT3	5-14
SMSJ48A		1SMB48AT3	5-14
SMSJ5.0		1SMB5.0AT3	5-14
SMSJ5.0A		1SMB5.0AT3	5-14
SMSJ51		1SMB51AT3	5-14
SMSJ51A		1SMB51AT3	5-14
SMSJ54		1SMB54AT3	5-14
SMSJ54A		1SMB54AT3	5-14
SMSJ58		1SMB58AT3	5-14
SMSJ58A		1SMB58AT3	5-14
SMSJ6.0		1SMB6.0AT3	5-14
SMSJ6.0A		1SMB6.0AT3	5-14
SMSJ6.5		1SMB6.5AT3	5-14
SMSJ6.5A		1SMB6.5AT3	5-14
SMSJ60		1SMB60AT3	5-14
SMSJ60A		1SMB60AT3	5-14
SMSJ64		1SMB64AT3	5-14
SMSJ64A		1SMB64AT3	5-14
SMSJ7.0		1SMB7.0AT3	5-14
SMSJ7.0A		1SMB7.0AT3	5-14
SMSJ7.5		1SMB7.5AT3	5-14
SMSJ7.5A		1SMB7.5AT3	5-14
SMSJ70		1SMB70AT3	5-14
SMSJ70A		1SMB70AT3	5-14
SMSJ75		1SMB75AT3	5-14
SMSJ75A		1SMB75AT3	5-14
SMSJ78		1SMB78AT3	5-14
SMSJ78A		1SMB78AT3	5-14
SMSJ8.0		1SMB8.0AT3	5-14
SMSJ8.0A		1SMB8.0AT3	5-14
SMSJ8.5		1SMB8.5AT3	5-14
SMSJ8.5A		1SMB8.5AT3	5-14
SMSJ85		1SMB85AT3	5-14
SMSJ85A		1SMB85AT3	5-14
SMSJ9.0		1SMB9.0AT3	5-14
SMSJ9.0A		1SMB9.0AT3	5-14
SMSJ90		1SMB90AT3	5-14
SMSJ90A		1SMB90AT3	5-14
SMZJ3789A		1SMB5925BT3	7-17
SMZJ3789B		1SMB5925BT3	7-17
SMZJ3790A		1SMB5926BT3	7-17
SMZJ3790B		1SMB5926BT3	7-17
SMZJ3791A		1SMB5927BT3	7-17
SMZJ3791B		1SMB5927BT3	7-17
SMZJ3792A		1SMB5928BT3	7-17
SMZJ3792B		1SMB5928BT3	7-17
SMZJ3793A		1SMB5929BT3	7-18
SMZJ3793B		1SMB5929BT3	7-18
SMZJ3794A		1SMB5930BT3	7-18

CF = consult factory representative



**CROSS-REFERENCE (continued)**

Industry Part Number	Motorola Direct Replacement	Motorola Similar Replacement	Page Number
SMZJ3794B		1SMB5930BT3	7-18
SMZJ3795A		1SMB5931BT3	7-18
SMZJ3795B		1SMB5931BT3	7-18
SMZJ3796A		1SMB5932BT3	7-18
SMZJ3796B		1SMB5932BT3	7-18
SMZJ3797A		1SMB5933BT3	7-18
SMZJ3797B		1SMB5933BT3	7-18
SMZJ3798A		1SMB5934BT3	7-18
SMZJ3798B		1SMB5934BT3	7-18
SMZJ3799A		1SMB5935BT3	7-18
SMZJ3799B		1SMB5935BT3	7-18
SMZJ3800A		1SMB5936BT3	7-18
SMZJ3800B		1SMB5936BT3	7-18
SMZJ3801A		1SMB5937BT3	7-18
SMZJ3801B		1SMB5937BT3	7-18
SMZJ3802A		1SMB5938BT3	7-18
SMZJ3802B		1SMB5938BT3	7-18
SMZJ3803A		1SMB5939BT3	7-18
SMZJ3803B		1SMB5939BT3	7-18
SMZJ3804A		1SMB5940BT3	7-18
SMZJ3804B		1SMB5940BT3	7-18
SMZJ3805A		1SMB5941BT3	7-18
SMZJ3805A		1SMB5941BT3	7-18
SMZJ3806A		1SMB5942BT3	7-18
SMZJ3806B		1SMB5942BT3	7-18
SMZJ3807A		1SMB5943BT3	7-18
SMZJ3807B		1SMB5943BT3	7-18
SMZJ3808A		1SMB5944BT3	7-18
SMZJ3808B		1SMB5944BT3	7-18
SMZJ3809A		1SMB5945BT3	7-18
SMZJ3809B		1SMB5945BT3	7-18
SMZJ5347A,B		P6SMB10AT3	5-16
SMZJ5348A,B		P6SMB11AT3	5-16
SMZJ5349A,B		P6SMB12AT3	5-16
SMZJ5350A,B		P6SMB13AT3	5-16
SMZJ5351A,B		P6SMB15AT3	5-16
SMZJ5352A,B		P6SMB15AT3	5-16
SMZJ5353A,B		P6SMB16AT3	5-16
SMZJ5354A,B		P6SMB18AT3	5-16
SMZJ5355A,B		P6SMB18AT3	5-16
SMZJ5356A,B		P6SMB20AT3	5-16
SMZJ5357A,B		P6SMB20AT3	5-16
SMZJ5358A,B		P6SMB22AT3	5-16
SMZJ5359A,B		P6SMB24AT3	5-16
SMZJ5360A,B		P6SMB27AT3	5-16
SMZJ5361A,B		P6SMB27AT3	5-16
SMZJ5362A,B		P6SMB30AT3	5-16
SMZJ5363A,B		P6SMB30AT3	5-16
SMZJ5364A,B		P6SMB33AT3	5-16
SMZJ5365A,B		P6SMB36AT3	5-16

Industry Part Number	Motorola Direct Replacement	Motorola Similar Replacement	Page Number
SMZJ5366A,B		P6SMB39AT3	5-16
SMZJ5367A,B		P6SMB43AT3	5-16
SMZJ5368A,B		P6SMB47AT3	5-16
SMZJ5369A,B		P6SMB51AT3	5-16
SMZJ5370A,B		P6SMB56AT3	5-16
SMZJ5371A,B		P6SMB62AT3	5-16
SMZJ5372A,B		P6SMB62AT3	5-16
SMZJ5373A,B		P6SMB68AT3	5-16
SMZJ5374A,B		P6SMB75AT3	5-16
SOV10		SA10A	4-3
SOV12		SA12A	4-3
SOV15		SA15A	4-3
SOV18		SA18A	4-3
SOV24		SA26A	4-3
SOV28		SA28A	4-3
SOV5.0		SA5.0A	4-3
TS-7		1N5908	4-16
TVS305		SA5.0A	4-3
TVS310		SA10A	4-3
TVS312		SA12A	4-3
TVS315		SA15A	4-3
TVS318		SA18A	4-3
TVS324		SA24A	4-3
TVS328		SA28A	4-3
TVS348		SA48A	4-3
TVS360		SA60A	4-3
TVS410		SA100A	4-3
TVS505		SA5.0A	4-3
TVS510		SA10A	4-3
TVS512		SA12A	4-3
TVS515		SA15A	4-3
TVS518		SA18A	4-3
TVS524		SA24A	4-3
TVS528		SA28A	4-3
ZPD10	ZPD10RL		6-16
ZPD11	ZPD11RL		6-16
ZPD12	ZPD12RL		6-16
ZPD13	ZPD13RL		6-16
ZPD15	ZPD15RL		6-16
ZPD16	ZPD16RL		6-16
ZPD18	ZPD18RL		6-16
ZPD2.7	ZPD2.7RL		6-16
ZPD20	ZPD20RL		6-16
ZPD22	ZPD22RL		6-16
ZPD24	ZPD24RL		6-16
ZPD27	ZPD27RL		6-16
ZPD3.0	ZPD3.0RL		6-16
ZPD3.3	ZPD3.3RL		6-16
ZPD3.6	ZPD3.6RL		6-16
ZPD3.9	ZPD3.9RL		6-16

CF = consult factory representative

**CROSS-REFERENCE (continued)**

<b>Industry Part Number</b>	<b>Motorola Direct Replacement</b>	<b>Motorola Similar Replacement</b>	<b>Page Number</b>
ZPD30	ZPD30RL		6-16
ZPD33	ZPD33RL		6-16
ZPD4.3	ZPD4.3RL		6-16
ZPD4.7	ZPD4.7RL		6-16
ZPD5.1	ZPD5.1RL		6-16
ZPD5.6	ZPD5.6RL		6-16

<b>Industry Part Number</b>	<b>Motorola Direct Replacement</b>	<b>Motorola Similar Replacement</b>	<b>Page Number</b>
ZPD6.2	ZPD6.2RL		6-16
ZPD6.8	ZPD6.8RL		6-16
ZPD7.5	ZPD7.5RL		6-16
ZPD8.2	ZPD8.2RL		6-16
ZPD9.1	ZPD9.1RL		6-16

CF = consult factory representative

# Section Three

## Selector Guide for Transient Voltage Suppressors and Zener Diodes

### In Brief . . .

Motorola's standard TVS (Transient Voltage Suppressors) and Zener diodes comprise the largest inventoried line in the industry. Continuous development of improved manufacturing techniques have resulted in computerized diffusion and test, as well as critical process controls learned from surface-sensitive MOS fabrication. Resultant high yields lower factory costs. Check the following features for application to your specific requirements:

- Wide selection of package materials and styles:
  - Plastic (Surmetic) for low cost, mechanical ruggedness
  - Glass for high reliability, low cost
  - Surface Mount packages for state of the art designs
- Power Ratings from 0.25 to 5.0 Watts
- Breakdown voltages from 1.8 to 400 Volts in approximately 10% steps
- TVS from 24 to 1500 Watts and from 6.2 to 250 Volts
- ESD protection devices
- Available tolerances from 5% (low cost) to as tight as 1% (critical applications)
- Special selection of electrical characteristics available at low cost due to high-volume lines (check your Motorola sales representative for special quotations)
- UL Recognition on many TVS device types
- Tape and Reel options available on all axial leaded and surface mount types

<b>TVS (Transient Voltage Suppressors)</b> . . . . .	3-2
General-Purpose . . . . .	3-2
Axial Leaded for Through-hole Designs . . . . .	3-2
Surface Mount Packages . . . . .	NO TAG
Overtolerance Transient Suppressors . . . . .	NO TAG
<b>Zener Diodes</b> . . . . .	NO TAG
Voltage Regulator Diodes . . . . .	NO TAG
Axial Leaded for Through-hole Designs	
500 mW . . . . .	NO TAG
Axial Leaded for Through-hole Designs	
1, 1.3, 1.5, 3 and 5 Watt . . . . .	NO TAG
Surface Mount Packages . . . . .	NO TAG
Voltage Reference Diodes . . . . .	NO TAG
Temperature Compensated Reference	
Devices . . . . .	NO TAG
Current Regulator Diodes . . . . .	NO TAG

# TVS (Transient Voltage Suppressors)

## General-Purpose

Transient Voltage Suppressors are designed for applications requiring protection of voltage sensitive electronic devices in danger of destruction by high energy voltage transients. Many of the zener voltage regulator diodes listed in the previous charts are in fact used in circuits as transient voltage suppressors. The purpose of this section is to present the families of Motorola Zeners that are specified with the key transient voltage suppressor parameters and limits, e.g., maximum clamping voltage at maximum surge current rating and working peak reverse (stand-off) voltage.


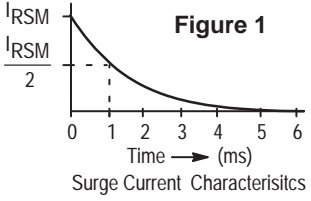
Selection sequence:

1. Package type (axial or surface mount)
2. Peak surge power expected for the application
3. Working peak reverse stand-off voltage (or the breakdown voltage)
4. Maximum reverse clamping voltage

Consult the factory for special electrical selections if there is no standard device type available to fit the application.

## Axial Leaded for Through-hole Designs

**Table 1. Peak Power Dissipation<sup>(3)</sup> (500 Watts @ 1 ms Surge – Figure 1)  
Case 59-04 — Mini Mosorb**

							
<b>ELECTRICAL CHARACTERISTICS</b> ( $T_A = 25^\circ\text{C}$ unless otherwise noted) $V_F = 3.5\text{ V Max}$ , $I_F = 35\text{ A Pulse}$ (except bidirectional devices).							
Working Peak Reverse Voltage $V_{RWM}$ (Volts)	Device <sup>(4)</sup>	Breakdown Voltage			Maximum Reverse Leakage @ $V_{RWM}$ $I_R$ ( $\mu\text{A}$ )	Maximum Reverse Surge Current $I_{RSM}$ Figure 1 (Amps)	Maximum Reverse Voltage @ $I_{RSM}$ (Clamping Voltage) $V_{RSM}$ (Volts)
		$V_{BR}$ (Volts)		@ $I_T$ Pulse (mA)			
		Min	Max				
5	<b>SA5.0A</b>	6.4	7	10	600	54.3	9.2
6	<b>SA6.0A</b>	6.67	7.37	10	600	48.5	10.3
6.5	SA6.5A	7.22	7.98	10	400	44.7	11.2
7	SA7.0A	7.78	8.6	10	150	41.7	12
7.5	SA7.5A	8.33	9.21	1	50	38.8	12.9
8	SA8.0A	8.89	9.83	1	25	36.7	13.6
8.5	SA8.5A	9.44	10.4	1	5	34.7	14.4
9	SA9.0A	10	11.1	1	1	32.5	15.4
10	SA10A	11.1	12.3	1	1	29.4	17
11	<b>SA11A</b>	12.2	13.5	1	1	27.4	18.2
12	<b>SA12A</b>	13.3	14.7	1	1	25.1	19.9
13	SA13A	14.4	15.9	1	1	23.2	21.5
14	SA14A	15.6	17.2	1	1	21.5	23.2
15	<b>SA15A</b>	16.7	18.5	1	1	20.6	24.4
16	SA16A	17.8	19.7	1	1	19.2	26
17	SA17A	18.9	20.9	1	1	18.1	27.6

<sup>(3)</sup> Steady state power dissipation = 3 watt max rating

<sup>(4)</sup> For bidirectional types use CA suffix, **SA6.5CA**, **SA12CA**, **SA13CA** and **SA15CA** are Motorola preferred devices. Have cathode polarity band on each end. (Consult factory for availability).

Devices listed in bold, italic are Motorola preferred devices.

# TVS

## Axial Leaded for Through-hole Designs (continued)

**Table 1. Peak Power Dissipation<sup>(3)</sup> (500 Watts @ 1 ms Surge – Figure 1)**  
**Case 59-04 — Mini Mosorb** (continued)

ELECTRICAL CHARACTERISTICS (T <sub>A</sub> = 25°C unless otherwise noted) V <sub>F</sub> = 3.5 V Max, I <sub>F</sub> = 35 A Pulse (except bidirectional devices).							
Working Peak Reverse Voltage V <sub>RWM</sub> (Volts)	Device <sup>(4)</sup>	Breakdown Voltage			Maximum Reverse Leakage @ V <sub>RWM</sub> I <sub>R</sub> (μA)	Maximum Reverse Surge Current I <sub>RSM</sub> Figure 1 (Amps)	Maximum Reverse Voltage @ I <sub>RSM</sub> (Clamping Voltage) V <sub>RSM</sub> (Volts)
		V <sub>BR</sub> (Volts)		@ I <sub>T</sub> Pulse (mA)			
		Min	Max				
18	SA18A	20	22.1	1	1	17.2	29.2
20	SA20A	22.2	24.5	1	1	15.4	32.4
22	SA22A	24.4	26.9	1	1	14.1	35.5
24	SA24A	26.7	29.5	1	1	12.8	38.9
26	SA26A	28.9	31.9	1	1	11.9	42.1
28	SA28A	31.1	34.4	1	1	11	45.4
30	SA30A	33.3	36.8	1	1	10.3	48.4
33	SA33A	36.7	40.6	1	1	9.4	53.3
36	SA36A	40	44.2	1	1	8.6	58.1
40	SA40A	44.4	49.1	1	1	7.8	64.5
43	SA43A	47.8	52.8	1	1	7.2	69.4
45	SA45A	50	55.3	1	1	6.9	72.7
48	SA48A	53.3	58.9	1	1	6.5	77.4
51	SA51A	56.7	62.7	1	1	6.1	82.4
54	SA54A	60	66.3	1	1	5.7	87.1
58	SA58A	64.4	71.2	1	1	5.3	93.6
60	SA60A	66.7	73.7	1	1	5.2	96.8
64	SA64A	71.1	78.6	1	1	4.9	103
70	SA70A	77.8	86	1	1	4.4	113
75	SA75A	83.3	92.1	1	1	4.1	121
78	SA78A	86.7	95.8	1	1	4	126
85	SA85A	94.4	104	1	1	3.6	137
90	<b>SA90A</b>	100	111	1	1	3.4	146
100	SA100A	111	123	1	1	3.1	162
110	SA110A	122	135	1	1	2.8	177
120	SA120A	133	147	1	1	2.5	193
130	SA130A	144	159	1	1	2.4	209
150	SA150A	167	185	1	1	2.1	243
160	SA160A	178	197	1	1	1.9	259
170	SA170A	189	209	1	1	1.8	275

(3) Steady state power dissipation = 3 watt max rating

(4) For bidirectional types use CA suffix, **SA18CA** and **SA24CA** are Motorola preferred devices. Have cathode polarity band on each end. (Consult factory for availability).

# TVS

## Axial Leaded for Through-hole Designs (continued)

**Table 2. Peak Power Dissipation<sup>(5)</sup> (600 Watts @ 1 ms Surge – Figure 1)  
Case 17 — Surmetic 40**

Breakdown Voltage <sup>(6)</sup>		Device <sup>(4, 7)</sup>	Working Peak Reverse Voltage $V_{RWM}$ (Volts)	Maximum Reverse Leakage @ $V_{RWM}$ $I_R$ ( $\mu$ A)	Maximum Reverse Surge Current $I_{RSM}$ Figure 1 (Amps)	Maximum Reverse Voltage @ $I_{RSM}$ (Clamping Voltage) $V_{RSM}$ (Volts)
$V_{BR}$ (Volts)	@ $I_T$ Pulse (mA)					
Nom						
6.8	10	<b>P6KE6.8A</b>	5.8	1000	57	10.5
7.5	10	P6KE7.5A	6.4	500	53	11.3
8.2	10	P6KE8.2A	7.02	200	50	12.1
9.1	1	P6KE9.1A	7.78	50	45	13.4
10	1	P6KE10A	8.55	10	41	14.5
11	1	P6KE11A	9.4	5	38	15.6
12	1	P6KE12A	10.2	5	36	16.7
13	1	P6KE13A	11.1	5	33	18.2
15	1	<b>P6KE15A</b>	12.8	5	28	21.2
16	1	P6KE16A	13.6	5	27	22.5
18	1	P6KE18A	15.3	5	24	25.2
20	1	P6KE20A	17.1	5	22	27.7
22	1	P6KE22A	18.8	5	20	30.6
24	1	P6KE24A	20.5	5	18	33.2
27	1	P6KE27A	23.1	5	16	37.5
30	1	P6KE30A	25.6	5	14.4	41.4
33	1	P6KE33A	28.2	5	13.2	45.7
36	1	P6KE36A	30.8	5	12	49.9
39	1	P6KE39A	33.3	5	11.2	53.9
43	1	P6KE43A	36.8	5	10.1	59.3
47	1	P6KE47A	40.2	5	9.3	64.8
51	1	P6KE51A	43.6	5	8.6	70.1
56	1	P6KE56A	47.8	5	7.8	77
62	1	P6KE62A	53	5	7.1	85
68	1	P6KE68A	58.1	5	6.5	92
75	1	P6KE75A	64.1	5	5.8	103
82	1	P6KE82A	70.1	5	5.3	113
91	1	P6KE91A	77.8	5	4.8	125
100	1	P6KE100A	85.5	5	4.4	137
110	1	P6KE110A	94	5	4	152
120	1	P6KE120A	102	5	3.6	165
130	1	P6KE130A	111	5	3.3	179

(4) For bidirectional types use CA suffix, **P6KE7.5CA** and **P6KE11CA** are Motorola preferred devices.

Have cathode polarity band on each end. (Consult factory for availability).

(5) Steady state power dissipation = 5 watt max rating.

(6) Breakdown voltage tolerance is  $\pm 5\%$  for A suffix.

(7) UL recognition for classification of protectors (QVGV2) under the UL standard for safety 497B and file #E116110 for entire series including CA suffixes.

Devices listed in bold, italic are Motorola preferred devices.

# TVS

## Axial Leaded for Through-hole Designs (continued)

**Table 2. Peak Power Dissipation<sup>(5)</sup> (600 Watts @ 1 ms Surge – Figure 1)**  
**Case 17 — Surmetic 40** (continued)

<b>ELECTRICAL CHARACTERISTICS</b> ( $T_A = 25^\circ\text{C}$ unless otherwise noted) $V_F = 3.5\text{ V Max}$ , $I_F = 50\text{ A Pulse}$ (except bidirectional devices).						
<b>Breakdown Voltage<sup>(6)</sup></b>		<b>Device<sup>(4, 7)</sup></b>	<b>Working Peak Reverse Voltage <math>V_{RWM}</math> (Volts)</b>	<b>Maximum Reverse Leakage @ <math>V_{RWM}</math> <math>I_R</math> (<math>\mu\text{A}</math>)</b>	<b>Maximum Reverse Surge Current <math>I_{RSM}</math> Figure 1 (Amps)</b>	<b>Maximum Reverse Voltage @ <math>I_{RSM}</math> (Clamping Voltage) <math>V_{RSM}</math> (Volts)</b>
<b><math>V_{BR}</math> (Volts)</b>	<b>@ <math>I_T</math> Pulse (mA)</b>					
<b>Nom</b>						
150	1	P6KE150A	128	5	2.9	207
160	1	P6KE160A	136	5	2.7	219
170	1	P6KE170A	145	5	2.6	234
180	1	P6KE180A	154	5	2.4	246
200	1	P6KE200A	171	5	2.2	274

(4) For bidirectional types use CA suffix. Have cathode polarity band on each end. (Consult factory for availability).

(5) Steady state power dissipation = 5 watt max rating.

(6) Breakdown voltage tolerance is  $\pm 5\%$  for A suffix.


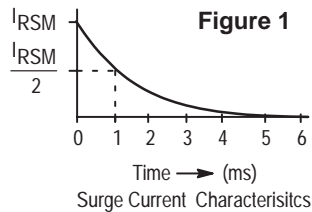
(7) UL recognition for classification of protectors (QVGV2) under the UL standard for safety 497B and file #E116110 for entire series including CA suffixes.

Devices listed in bold, italic are Motorola preferred devices.

# TVS

## Axial Leaded for Through-hole Designs (continued)

**Table 3. Peak Power Dissipation<sup>(5)</sup> (1500 WATTS @ 1 ms Surge – Figure 1)  
Case 41A — Mosorb**

<div style="display: flex; justify-content: space-between; align-items: center;">  <div style="text-align: center;"> <p><b>CASE 41A PLASTIC</b> Cathode = Polarity Band</p> </div>  </div>									
<b>ELECTRICAL CHARACTERISTICS</b> ( $T_A = 25^\circ\text{C}$ unless otherwise noted) $V_F = 3.5\text{ V Max}$ , $I_F = 100\text{ A Pulse}$ (C suffix denotes standard back to back bidirectional versions. Test both polarities)									
Maximum Reverse Stand-Off Voltage $V_{RWM}$ (Volts)	JEDEC <sup>(8)</sup> Device	Device <sup>(8)</sup>	Breakdown Voltage		Maximum Reverse Leakage @ $V_{RWM}$ $I_R$ ( $\mu\text{A}$ )	Maximum Reverse Surge Current Figure 1 $I_{RSM}$ (Volts)	Maximum Reverse Voltage @ $I_{RSM}$ (Clamping Voltage) $V_{RSM}$ (Volts)	Clamping Voltage <sup>(9)</sup>	
			$V_{BR}$ Volts Min	@ $I_T$ Pulse (mA)				Peak Pulse Current @ $I_{pp1} = 1\text{ A}$ Figure 1 $V_{C1}$ (Volts max)	Peak Pulse Current @ $I_{pp2} = 10\text{ A}$ Figure 1 $V_{C2}$ (Volts max)
5	<b>1N5908</b>		6	1	300	120	8.5	7.6 @ 30 A	8 @ 60 A
5	<b>1N6373</b>	<b>ICTE-5/MPTE-5</b>	6	1	300	160	9.4	7.1	7.5
8	1N6374	ICTE-8/MPTE-8	9.4	1	25	100	15	11.3	11.5
8	1N6382	ICTE-8C/MPTE-8C	9.4	1	25	100	15	11.4	11.6
10	1N6375	ICTE-10/MPTE-10	11.7	1	2	90	16.7	13.7	14.1
10	1N6383	ICTE-10C/MPTE-10C	11.7	1	2	90	16.7	14.1	14.5
12	1N6376	ICTE-12/MPTE-12	14.1	1	2	70	21.2	16.1	16.5
12	1N6384	ICTE-12C/MPTE-12C	14.1	1	2	70	21.2	16.7	17.1
15	1N6377	ICTE-15/MPTE-15	17.6	1	2	60	25	20.1	20.6
15	1N6385	ICTE-15C/MPTE-15C	17.6	1	2	60	25	20.8	21.4
18	1N6378	ICTE-18/MPTE-18	21.2	1	2	50	30	24.2	25.2
18	1N6386	ICTE-18C/MPTE-18C	21.2	1	2	50	30	24.8	25.5
22	1N6379	ICTE-22/MPTE-22	25.9	1	2	40	37.5	29.8	32
22	1N6387	ICTE-22C/MPTE-22C	25.9	1	2	40	37.5	30.8	32
36	1N6380	ICTE-36/MPTE-36	42.4	1	2	23	65.2	50.6	54.3
36	1N6388	ICTE-36C/MPTE-36C	42.4	1	2	23	65.2	50.6	54.3
45	1N6381	ICTE-45/MPTE-45	52.9	1	2	19	78.9	63.3	70
45	1N6389	ICTE-45C/MPTE-45C	52.9	1	2	19	78.9	63.3	70

<sup>(5)</sup> Steady state power dissipation = 5 watts max rating.

<sup>(8)</sup> 1N6382 thru 1N6389 and C suffix ICTE/MPTE device types are bidirectional. Have cathode polarity band on each end. All other device types are unidirectional only. (Consult factory for availability)

<sup>(9)</sup> Clamping voltage peak pulse currents for 1N5908 are 30 Amps and 60 Amps.



# TVS

## Axial Led for Through-hole Designs (continued)

Table 4. Peak Power Dissipation<sup>(5)</sup> (1500 Watts @ 1 ms Surge – Figure 1)  
Case 41A – Mosorb

Breakdown Voltage <sup>(6)</sup>		JEDEC Device	Device <sup>(10, 11)</sup>	Working Peak Reverse Voltage $V_{RWM}$ (Volts)	Maximum Reverse Leakage @ $V_{RWM}$ $I_R$ ( $\mu$ A)	Maximum Reverse Surge Current Figure 1 $I_{RSM}$ (Amps)	Maximum Reverse Voltage @ $I_{RSM}$ (Clamping Voltage) $V_{RSM}$ (Volts)
$V_{BR}$ Volts	@ $I_T$ Pulse (mA)						
Nom							
6.8	10	<b>1N6267A</b>	1.5KE6.8A	5.8	1000	143	10.5
7.5	10	1N6268A	1.5KE7.5A	6.4	500	132	11.3
8.2	10	1N6269A	1.5KE8.2A	7.02	200	124	12.1
9.1	1	1N6270A	1.5KE9.1A	7.78	50	112	13.4
10	1	1N6271A	1.5KE10A	8.55	10	103	14.5
11	1	1N6272A	1.5KE11A	9.4	5	96	15.6
12	1	1N6273A	1.5KE12A	10.2	5	90	16.7
13	1	1N6274A	1.5KE13A	11.1	5	82	18.2
15	1	<b>1N6275A</b>	1.5KE15A	12.8	5	71	21.2
16	1	1N6276A	1.5KE16A	13.6	5	67	22.5
18	1	1N6277A	1.5KE18A	15.3	5	59.5	25.2
20	1	1N6278A	1.5KE20A	17.1	5	54	27.7
22	1	1N6279A	<b>1.5KE22A</b>	18.8	5	49	30.6
24	1	<b>1N6280A</b>	1.5KE24A	20.5	5	45	33.2
27	1	<b>1N6281A</b>	1.5KE27A	23.1	5	40	37.5
30	1	<b>1N6282A</b>	1.5KE30A	25.6	5	36	41.4
33	1	<b>1N6283A</b>	1.5KE33A	28.2	5	33	45.7
36	1	1N6284A	1.5KE36A	30.8	5	30	49.9
39	1	<b>1N6285A</b>	<b>1.5KE39A</b>	33.3	5	28	53.9
43	1	1N6286A	1.5KE43A	36.8	5	25.3	59.3
47	1	1N6287A	1.5KE47A	40.2	5	23.2	64.8
51	1	<b>1N6288A</b>	1.5KE51A	43.6	5	21.4	70.1
56	1	1N6289A	1.5KE56A	47.8	5	19.5	77
62	1	1N6290A	1.5KE62A	53	5	17.7	85
68	1	1N6291A	1.5KE68A	58.1	5	16.3	92
75	1	1N6292A	1.5KE75A	64.1	5	14.6	103
82	1	1N6293A	1.5KE82A	70.1	5	13.3	113
91	1	1N6294A	1.5KE91A	77.8	5	12	125
100	1	1N6295A	1.5KE100A	85.5	5	11	137
110	1	1N6296A	1.5KE110A	94	5	9.9	152
120	1	1N6297A	1.5KE120A	102	5	9.1	165
130	1	1N6298A	1.5KE130A	111	5	8.4	179

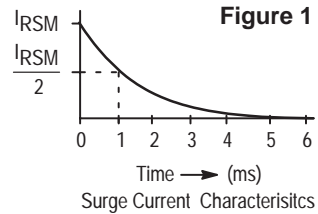
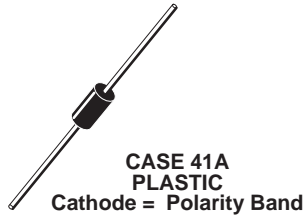
(5) Steady state power dissipation = 5 watts max rating.

(6) Breakdown voltage tolerance is  $\pm 5\%$  for A suffix.

(10) For bidirectional types use CA suffix on 1.5KE series only. Have cathode polarity band on each end. (Consult factory for availability)

1N6267-6303A series do not have CA option since the CA is not included in EIA Registration.

(11) UL recognition for classification of protectors (QVGV2) under the UL standard for safety 497B and file #E116110 for 1.5KE6.8A,CA thru 1.5KE250A,CA.



Devices listed in bold, italic are Motorola preferred devices.

# TVS

## Axial Leaded for Through-hole Designs (continued)

**Table 4. Peak Power Dissipation<sup>(5)</sup> (1500 Watts @ 1 ms Surge – Figure 1)**  
**Case 41A – Mosorb (continued)**

ELECTRICAL CHARACTERISTICS (T <sub>A</sub> = 25°C unless otherwise noted) V <sub>F</sub> = 3.5 V Max, I <sub>F</sub> = 100 A Pulse							
Breakdown Voltage <sup>(6)</sup>		JEDEC Device	Device <sup>(10, 11)</sup>	Working Peak Reverse Voltage V <sub>RWM</sub> (Volts)	Maximum Reverse Leakage @ V <sub>RWM</sub> I <sub>R</sub> (μA)	Maximum Reverse Surge Current Figure 1 I <sub>RSM</sub> (Amps)	Maximum Reverse Voltage @ I <sub>RSM</sub> (Clamping Voltage) V <sub>RSM</sub> (Volts)
V <sub>BR</sub> Volts	@ I <sub>F</sub> Pulse (mA)						
Nom							
150	1	1N6299A	1.5KE150A	128	5	7.2	207
160	1	1N6300A	1.5KE160A	136	5	6.8	219
170	1	1N6301A	1.5KE170A	145	5	6.4	234
180	1	1N6302A	1.5KE180A	154	5	6.1	246
200	1	1N6303A	1.5KE200A	171	5	5.5	274
220	1		1.5KE220A	185	5	4.6	328
250	1		1.5KE250A	214	5	5	344

<sup>(5)</sup> Steady state power dissipation = 5 watts max rating.

<sup>(6)</sup> Breakdown voltage tolerance is ±5% for A suffix.

<sup>(10)</sup> For bidirectional types use CA suffix. Have cathode polarity band on each end. (Consult factory for availability).

1N6267-6303A series do not have CA option since the CA is not included in EIA Registration.

<sup>(11)</sup> UL recognition for classification of protectors (QVGV2) under the UL standard for safety 497B and file #E116110 for 1.5KE6.8A,CA thru 1.5KE250A,CA.

Devices listed in bold, italic are Motorola preferred devices.

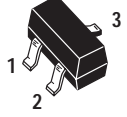
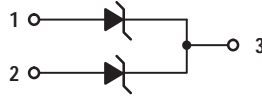
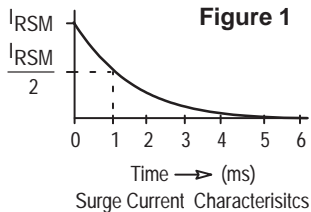
# TVS

## Axial Leaded for Through-hole Designs (continued)

### Surface Mount Packages

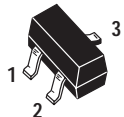
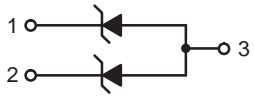
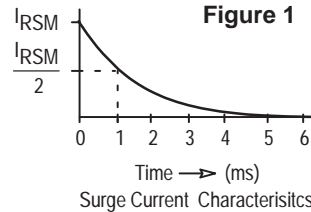
**Table 5. Peak Power Dissipation (40 Watts @ 1 ms Surge – Figure 1)(28)**  
**Case 318-07 — Common Cathode**

MMBZ15VDLT1(12) — SOT-23 Dual Monolithic Common Cathode Bipolar Zener (for ESD protection)

 <p>CASE 318-07, STYLE 9 TO-236AB LOW PROFILE SOT-23 PLASTIC</p>		<p>Pinout: TERMINAL 1 — ANODE TERMINAL 2 — ANODE TERMINAL 3 — COMMON CATHODE</p> 		 <p><b>Figure 1</b> Surge Current Characteristics</p>			
<p><b>ELECTRICAL CHARACTERISTICS</b> (<math>T_A = 25^\circ\text{C}</math> unless otherwise noted)</p> <p><b>BIDIRECTIONAL</b> (Circuit tied to pins 1 and 2)</p>							
Breakdown Voltage			Working Peak Reverse Voltage $V_{RWM}$ (Volts)	Maximum Reverse Leakage Current $I_{RWM}$ $I_R$ (nA)	Maximum Reverse Surge Current $I_{RSM}$ (Amps)	Maximum Reverse Voltage @ $I_{RMS}$ (Clamping Voltage) $V_{RSM}$ (Volts)	Maximum Temperature Coefficient of $V_{BR}$ (mV/°C)
$V_{BR}^{(14)}$ (Volts)							
Min	Nom	Max	12.8	100	1.9	21.2	12

**Table 6. Peak Power Dissipation (24 Watts @ 1 ms Surge – Figure 1)(28)**  
**Case 318-07 — Common Anode**

MMBZ5V6ALT1(12) — SOT-23 Dual Monolithic Common Anode Zener (for ESD Protection)

 <p>CASE 318-07, STYLE 12 TO-236AB LOW PROFILE SOT-23 PLASTIC</p>		 <p>PIN 1. CATHODE 2. CATHODE 3. COMMON ANODE</p>		 <p><b>Figure 1</b> Surge Current Characteristics</p>					
<p><b>ELECTRICAL CHARACTERISTICS</b> (<math>T_A = 25^\circ\text{C}</math> unless otherwise noted)</p> <p><b>UNIDIRECTIONAL</b> (Circuit tied to pins 1 and 3 or Pins 2 and 3) (<math>V_F = 0.9\text{ V Max @ } I_F = 10\text{ mA}</math>)</p>									
Breakdown Voltage			Max Reverse Leakage Current		Max Zener Impedance(21)		Max Reverse Surge Current $I_{RSM}^{(4)}$ (A)	Max Reverse Voltage @ $I_{RSM}$ (Clamping Voltage) $V_{RSM}$ (V)	Maximum Temperature Coefficient of $V_{BR}$ (mV/°C)
$V_{BR}^{(14)}$ (Volts)			$I_R$ @ $V_R$ ( $\mu\text{A}$ ) (V)	$Z_{ZT}$ @ $I_{ZT}$ ( $\Omega\text{A}$ ) (mA)	$Z_{ZK}$ @ $I_{ZK}$ ( $\Omega$ ) (mA)				
Min	Nom	Max				@ $I_T$ (mA)	11	1600	0.25

(12) T1 suffix designates tape and reel of 3000 units.

(14)  $V_{BR}$  measured at pulse test current  $I_T$  at an ambient temperature of  $25^\circ\text{C}$ .

(21)  $Z_{ZT}$  and  $Z_{ZK}$  are measured by dividing the AC voltage drop across the device by the AC current supplied.

The specified limits are  $I_{Z(AC)} = 0.1 I_{Z(DC)}$ , with AC frequency = 1 kHz.

(28) Other voltages may be available upon request. Contact your Motorola representative.

# TVS

## Axial Leaded for Through-hole Designs (continued)

Table 7. TVS SA Series Through-hole to SMB Series Surface Mount Packages

Peak Pulse Power Rating at 1 ms		500 W			600 W		
Application		Through-hole			Surface Mount		
Series		SA			1 SMB		
Package		Case 59-04			Case 403A		
Polarity		UNI	BI		UNI	BI	
Reverse Stand-Off Voltage (29) $V_R$ Volts	Maximum Clamping Voltage @ $I_{pp}$ $V_C$ Volts	Part Number	Part Number	Maximum Peak Pulse Current $I_{pp}$ Amps	Part Number	Part Number	Maximum Peak Pulse Current $I_{pp}$ Amps
5	9.2	<b>SA5.0A</b>		54.3	<b>1SMB5.0AT3</b>		65.2
6	10.3	<b>SA6.0A</b>	SA6.0CA	48.5	<b>1SMB6.0AT3</b>		58.3
6.5	11.2	SA6.5A	SA6.5CA	44.7	1SMB6.5AT3		53.6
7	12	SA7.0A	SA7.0CA	41.7	1SMB7.0AT3		50.0
7.5	12.9	SA7.5A	<b>SA7.5CA</b>	38.8	1SMB7.5AT3		46.5
8	13.6	SA8.0A	SA8.0CA	36.7	1SMB8.0AT3		44.1
8.5	14.4	SA8.5A	SA8.5CA	34.7	1SMB8.5AT3		41.7
9	15.4	SA9.0A	SA9.0CA	32.5	1SMB9.0AT3		39.0
10	17	SA10A	SA10CA	29.4	1SMB10AT3	1SMB10CAT3	35.3
11	18.2	<b>SA11A</b>	SA11CA	27.4	1SMB11AT3	1SMB11CAT3	33
12	19.2	<b>SA12A</b>	SA12CA	25.1	1SMB12AT3	1SMB12CAT3	30.2
13	21.5	SA13A	<b>SA13CA</b>	23.2	1SMB13AT3	1SMB13CAT3	27.9
14	23.2	SA14A	SA14CA	21.5	1SMB14AT3	1SMB14CAT3	25.8
15	24.4	<b>SA15A</b>	<b>SA15CA</b>	20.6	1SMB15AT3	<b>1SMB15CAT3</b>	24
16	26	SA16A	SA16CA	19.2	1SMB16AT3	1SMB16CAT3	23.1
17	27.6	SA17A	SA17CA	18.1	1SMB17AT3	1SMB17CAT3	21.7
18	29.2	SA18A	<b>SA18CA</b>	17.2	1SMB18AT3	1SMB18CAT3	20.5
20	32.4	SA20A	SA20CA	15.4	1SMB20AT3	1SMB20CAT3	18.5
22	35.5	SA22A	SA22CA	14.1	<b>1SMB22AT3</b>	1SMB22CAT3	16.9
24	38.9	SA24A	SA24CA	12.8	1SMB24AT3	1SMB24CAT3	15.4
26	42.1	SA26A	SA26CA	11.9	1SMB26AT3	1SMB26CAT3	14.2
28	45.4	SA28A	SA28CA	11	1SMB28AT3	1SMB28CAT3	13.2
30	48.4	SA30A	SA30CA	10.3	1SMB30AT3	1SMB30CAT3	12.4
33	53.3	SA33A	SA33CA	9.4	1SMB33AT3	1SMB33CAT3	11.3
36	58.1	SA36A	SA36CA	8.6	1SMB36AT3	1SMB36CAT3	10.3
40	64.5	SA40A	SA40CA	7.8	1SMB40AT3	1SMB40CAT3	9.3
43	69.4	SA43A	SA43CA	7.2	1SMB43AT3	1SMB43CAT3	8.6
45	72.7	SA45A	SA45CA	6.9	1SMB45AT3	1SMB45CAT3	8.3
48	77.4	SA48A	SA48CA	6.5	1SMB48AT3	1SMB48CAT3	7.7
51	82.4	SA51A	SA51CA	6.1	1SMB51AT3	1SMB51CAT3	7.3
54	87.1	SA54A	SA54CA	5.7	1SMB54AT3	1SMB54CAT3	6.9
58	93.6	SA58A	SA58CA	5.3	<b>1SMB58AT3</b>	1SMB58CAT3	6.4
60	96.8	SA60A	SA60CA	5.2	1SMB60AT3	1SMB60CAT3	6.2
64	103	SA64A	SA64CA	4.9	1SMB64AT3	1SMB64CAT3	5.8
70	113	SA70A	SA70CA	4.4	1SMB70AT3	1SMB70CAT3	5.3
75	121	SA75A	SA75CA	4.1	1SMB75AT3	1SMB75CAT3	4.9

(29) A transient suppressor is normally selected according to the reverse "Stand Off Voltage" ( $V_R$ ) which should be equal to or greater than the DC or continuous peak operating voltage level.

# TVS

## Axial Leaded for Through-hole Designs (continued)

### NO TAGTVS SA Series Through-hole to SMB Series Surface Mount Packages (continued)

Peak Pulse Power Rating at 1 ms		500 W			600 W		
Application		Through-hole			Surface Mount		
Series		SA			1 SMB		
Package		Case 59-04			Case 403A		
Polarity		UNI	BI		UNI	BI	
Reverse Stand-Off Voltage (29) $V_R$ Volts	Maximum Clamping Voltage @ $I_{pp}$ $V_C$ Volts	Part Number	Part Number	Maximum Peak Pulse Current $I_{pp}$ Amps	Part Number	Part Number	Maximum Peak Pulse Current $I_{pp}$ Amps
78	126	SA78A	SA78CA	4.0	1SMB78AT3	1SMB78CAT3	4.7
85	137	SA85A	SA85CA	3.6	1SMB85AT3		4.4
90	146	SA90A	SA90CA	3.4	1SMB90AT3		4.1
100	162	SA100A	SA100CA	3.1	1SMB100AT3		3.7
110	177	SA110A	SA110CA	2.8	1SMB110AT3		3.4
120	193	SA120A	SA120CA	2	1SMB120AT3		3.1
130	209	SA130A	SA130CA	2.4	1SMB130AT3		2.9
150	243	SA150A	SA150CA	2.1	1SMB150AT3		2.5
160	259	SA160A	SA160CA	1.9	1SMB160AT3		2.3
170	275	SA170A	SA170CA	1.8	1SMB170AT3		2.2

<sup>(29)</sup> A transient suppressor is normally selected according to the reverse "Stand Off Voltage" ( $V_R$ ) which should be equal to or greater than the DC or continuous peak operating voltage level.

Devices listed in bold, italic are Motorola preferred devices.

# TVS

## Axial Leaded for Through-hole Designs (continued)

**Table 8. TVS P6KE Series Through-hole to P6SMB Series Surface Mount Packages**

Peak Pulse Power Rating at 1 ms		600 W			600 W		
Application		Through-hole			Surface Mount		
Series		P6KE			P6SMB		
Package		Case 17			Case 403A		
Polarity		UNI	BI		UNI	BI	
Reverse Stand-Off Voltage (29) $V_R$ Volts	Maximum Clamping Voltage @ $I_{pp}$ $V_C$ Volts	Part Number	Part Number	Maximum Peak Pulse Current $I_{pp}$ Amps	Part Number	Part Number	Maximum Peak Pulse Current $I_{pp}$ Amps
5.8	10.5	<b><i>P6KE6.8A</i></b>	P6KE6.8CA	57	<b><i>P6SMB6.8AT3</i></b>		57
6.4	11.3	P6KE7.5A	P6KE7.5CA	53	<b><i>P6SMB7.5AT3</i></b>		53
7.02	12.1	P6KE8.2A	P6KE8.2CA	50	P6SMB8.2AT3		50
7.78	13.4	P6KE9.1A	P6KE9.1CA	45	P6SMB9.1AT3		45
8.55	14.5	P6KE10A	P6KE10CA	41	<b><i>P6SMB10AT3</i></b>		41
9.4	15.6	P6KE11A	P6KE11CA	38	P6SMB11AT3	P6SMB11CAT3	38
10.2	16.7	P6KE12A	P6KE12CA	36	P6SMB12AT3	P6SMB12CAT3	36
11.1	18.2	P6KE13A	P6KE13CA	33	<b><i>P6SMB13AT3</i></b>	P6SMB13CAT3	33
12.8	21.2	<b><i>P6KE15A</i></b>	P6KE15CA	28	<b><i>P6SMB15AT3</i></b>	<b><i>P6SMB15CAT3</i></b>	28
13.6	22.5	P6KE16A	P6KE16CA	27	<b><i>P6SMB16AT3</i></b>	P6SMB16CAT3	27
15.3	25.2	P6KE18A	P6KE18CA		<b><i>P6SMB18AT3</i></b>	P6SMB18CAT3	
17.1	27.7	P6KE20A	P6KE20CA	22	<b><i>P6SMB20AT3</i></b>	P6SMB20CAT3	22
18.8	30.6	P6KE22A	P6KE22CA	20	<b><i>P6SMB22AT3</i></b>	P6SMB22CAT3	20
20.5	33.2	P6KE24A	P6KE24CA	18	P6SMB24AT3	P6SMB24CAT3	18
23.1	37.7	P6KE27A	P6KE27CA	16	<b><i>P6SMB27AT3</i></b>	P6SMB27CAT3	16
25.6	41.4	P6KE30A	P6KE30CA	14.4	<b><i>P6SMB30AT3</i></b>	P6SMB30CAT3	14.4
28.2	45.7	P6KE33A	P6KE33CA	13.2	<b><i>P6SMB33AT3</i></b>	P6SMB33CAT3	13.2
30.8	49.9	P6KE36A	P6KE36CA	12	<b><i>P6SMB36AT3</i></b>	P6SMB36CAT3	12
33.3	53.9	P6KE39A	P6KE39CA	11.2	<b><i>P6SMB39AT3</i></b>	P6SMB39CAT3	11.2
36.8	59.3	P6KE43A	P6KE43CA	10.1	P6SMB43AT3	P6SMB43CAT3	10.1
40.2	64.8	P6KE47A	P6KE47CA	9.3	P6SMB47AT3	P6SMB47CAT3	9.3
43.6	70.1	P6KE51A	P6KE51CA	8.6	<b><i>P6SMB51AT3</i></b>	P6SMB51CAT3	8.6
47.8	77	P6KE56A	P6KE56CA	7.8	P6SMB56AT3	P6SMB56CAT3	7.8
53	85	P6KE62A	P6KE62CA	7.1	P6SMB62AT3	P6SMB62CAT3	7.1
58.1	92	P6KE68A	P6KE68CA	6.5	P6SMB68AT3	P6SMB68CAT3	6.5
64.1	103	P6KE75A	P6KE75CA	5.8	P6SMB75AT3	P6SMB75CAT3	5.8
70.1	113	P6KE82A	P6KE82CA	5.3	P6SMB82AT3	P6SMB82CAT3	5.3
77.8	125	P6KE91A	P6KE91CA	4.8	P6SMB91AT3	P6SMB91CAT3	4.8
85.5	137	P6KE100A	P6KE100CA	4.4	P6SMB100AT3		4.4
94	152	P6KE110A	P6KE110CA	4	P6SMB110AT3		4
102	165	P6KE120A	P6KE120CA	3.6	P6SMB120AT3		3.6
111	179	P6KE130A	P6KE130CA	3.3	P6SMB130AT3		3.3
128	207	P6KE150A	P6KE150CA	2.9	P6SMB150AT3		2.9
136	219	P6KE160A	P6KE160CA	2.7	P6SMB160AT3		2.7
145	234	P6KE170A	P6KE170CA	2.6	P6SMB170AT3		2.6
154	246	P6KE180A	P6KE180CA	2.4	P6SMB180AT3		2.4
171	274	P6KE200A	P6KE200CA	2.2	P6SMB200AT3		2.2

(29) A transient suppressor is normally selected according to the reverse "Stand Off Voltage" ( $V_R$ ) which should be equal to or greater than the DC or continuous peak operating voltage level.

Devices listed in bold, italic are Motorola preferred devices.

# TVS

## Axial Leaded for Through-hole Designs (continued)

**Table 9. TVS 1N6267A and 1.5KE Series Through-hole to 1.5SMC Series Surface Mount Packages**

Peak Pulse Power Rating at 1 ms		1500 W				
Application		Through-hole			Surface Mount	
Series		1N6267A	1.5KE		1.5SMC	
Package		Case 41A			Case 403A	
Polarity		UNI		BI	UNI	
Reverse Stand-Off Voltage (29) V <sub>R</sub> Volts	Maximum Clamping Voltage @ I <sub>pp</sub> V <sub>C</sub> Volts	JEDEC Part Number	Part Number	Part Number	Part Number	Maximum Peak Pulse Current I <sub>pp</sub> Amps
5.8	10.5	<b>1N6267A</b>	1.5KE6.8A <sup>(31)</sup>	1.5KE6.8CA	1.5SMC6.8AT3	143
6.4	11.3	1N6268A	1.5KE7.5A	1.5KE7.5CA	1.5SMC7.5AT3	132
7.02	12.1	1N6269A	1.5KE8.2A	1.5KE8.2CA	1.5SMC8.2AT3	124
7.78	13.4	1N6270A	1.5KE9.1A	1.5KE9.1CA	1.5SMC9.1AT3	112
8.55	14.5	1N6271A	1.5KE10A	1.5KE10CA	1.5SMC10AT3	103
9.4	15.6	1N6272A	1.5KE11A	1.5KE11CA	1.5SMC11AT3	96
10.2	16.7	1N6273A	1.5KE12A	1.5KE12CA	1.5SMC12AT3	90
11.1	18.2	1N6274A	1.5KE13A	1.5KE13CA	1.5SMC13AT3	82
12.8	21.2	<b>1N6275A</b>	1.5KE15A	1.5KE15CA	<b>1.5SMC15AT3</b>	71
13.6	22.5	1N6276A	1.5KE16A	1.5KE16CA	1.5SMC16AT3	67
15.3	25.2	1N6277A	1.5KE18A	1.5KE18CA	1.5SMC18AT3	59.5
17.1	27.7	1N6278A	1.5KE20A	1.5KE20CA	1.5SMC20AT3	54
18.8	30.6	1N6279A	<b>1.5KE22A</b>	1.5KE22CA	1.5SMC22AT3	49
20.5	33.2	<b>1N6280A</b>	1.5KE24A	1.5KE24CA	<b>1.5SMC24AT3</b>	45
23.1	37.7	<b>1N6281A</b>	1.5KE27A	1.5KE27CA	1.5SMC27AT3	40
25.6	41.4	<b>1N6282A</b>	1.5KE30A	1.5KE30CA	1.5SMC30AT3	36
28.2		<b>1N6283A</b>	1.5KE33A	1.5KE33CA	1.5SMC33AT3	33
30.8	49.9	1N6284A	1.5KE36A	<b>1.5KE36CA</b>	<b>1.5SMC36AT3</b>	30
33.3	53.9	<b>1N6285A</b>	<b>1.5KE39A</b>	1.5KE39CA	<b>1.5SMC39AT3</b>	28
36.8	59.3	1N6286A	1.5KE43A	1.5KE43CA	<b>1.5SMC43AT3</b>	25.3
40.2	64.8	1N6287A	1.5KE47A	1.5KE47CA	<b>1.5SMC47AT3</b>	23.2
43.6	70.1	<b>1N6288A</b>	1.5KE51A	1.5KE51CA	1.5SMC51AT3	21.4
47.8	77	1N6289A	<b>1.5KE56A</b>	1.5KE56CA	1.5SMC56AT3	19.5
53	85	1N6290A	1.5KE62A	1.5KE62CA	1.5SMC62AT3	17.7
58.1	92	1N6291A	1.5KE68A	1.5KE68CA	1.5SMC68AT3	16.3
64.1	103	1N6292A	1.5KE75A	1.5KE75CA	<b>1.5SMC75AT3</b>	14.6
70.1	113	1N6293A	1.5KE82A	1.5KE82CA	1.5SMC82AT3	13.3
77.8	125	1N6294A	1.5KE91A	1.5KE91CA	1.5SMC91AT3	12
85.5	137	1N6295A	1.5KE100A	1.5KE100CA		11
94	152	1N6296A	1.5KE110A	1.5KE110CA		9.9
102	165	1N6297A	1.5KE120A	1.5KE120CA		9.1
111	179	1N6298A	1.5KE130A	1.5KE130CA		8.4
128	207	1N6299A	1.5KE150A	1.5KE150CA		7.2
136	219	1N6300A	1.5KE160A	1.5KE160CA		6.8
145	234	1N6301A	1.5KE170A	1.5KE170CA		6.4
154	246	1N6302A	1.5KE180A	1.5KE180CA		6.1
171	274	1N6303A	1.5KE200A	1.5KE200CA		5.5

(29) A transient suppressor is normally selected according to the reverse "Stand Off Voltage" (V<sub>R</sub>) which should be equal to or greater than the DC or continuous peak operating voltage level.

(31) Not available as bidirectional.

Devices listed in bold, italic are Motorola preferred devices.

# TVS

## Axial Leaded for Through-hole Designs (continued)

Table 10. TVS 1SMC Surface Mount Packages

Peak Pulse Power Rating at 1 ms		1500 W	
Application		Surface Mount	
Series		1SMC	
Package		Case 403A	
Polarity		UNI	
Reverse Stand-Off Voltage $V_R$ Volts	Maximum Clamping Voltage @ $I_{pp}$ $V_C$ Volts	Part Number	Maximum Peak Pulse Current $I_{pp}$ Amps
5	9.2	1SMC5.0AT3	163
6	10.3	1SMC6.0AT3	145.6
6.5	11.2	1SMC6.5AT3	133.9
7	12	1SMC7.0AT3	125
7.5	12.9	1SMC7.5AT3	116.3
8	13.6	1SMC8.0AT3	110.3
8.5	14.4	1SMC8.5AT3	104.2
9	15.4	1SMC9.0AT3	97.4
10	17	1SMC10AT3	88.2
11	18.2	1SMC11AT3	82.4
12	19.9	1SMC12AT3	75.3
13	21.5	1SMC13AT3	69.7
14	23.2	1SMC14AT3	64.7
15	24.4	1SMC15AT3	61.5
16	26	1SMC16AT3	57.7
17	27.6	1SMC17AT3	53.3
18	29.2	1SMC18AT3	51.4
20	32.4	1SMC20AT3	46.3
22	35.5	1SMC22AT3	42.2
24	38.9	<b>1SMC24AT3</b>	38.6
26	42.1	1SMC26AT3	35.6
28	45.4	1SMC28AT3	33
30	48.4	1SMC30AT3	31
33	53.3	1SMC33AT3	28.1
36	58.1	1SMC36AT3	25.8
40	64.5	1SMC40AT3	23.2
43	69.4	1SMC43AT3	21.6
45	72.7	1SMC45AT3	20.6
48	77.4	1SMC48AT3	19.4
51	82.4	1SMC51AT3	18.2
54	87.1	1SMC54AT3	17.2
58	93.6	<b>1SMC58AT3</b>	16
60	96.8	1SMC60AT3	15.5
64	103	1SMC64AT3	14.6
70	113	1SMC70AT3	13.3
75	121	1SMC75AT3	12.4
78	126	1SMC78AT3	11.4

Devices listed in bold, italic are Motorola preferred devices.



# TVS

## Axial Leaded for Through-hole Designs (continued)

# Overvoltage Transient Suppressors

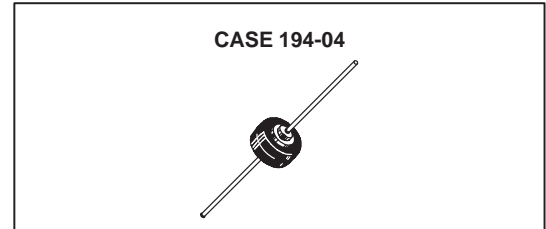
**Table 11. Overvoltage Transient Suppressors**

Overvoltage transient suppressors are designed for protection against over-voltage conditions in the auto electrical system including the "LOAD DUMP" phenomenon that occurs when the battery open circuits while the car is running.

OVERVOLTAGE TRANSIENT SUPPRESSOR	
	<b>CASE 194-04 MR2535L</b>
<b><math>V_{RRM}</math> (Volts)</b>	20
<b><math>I_O</math> (Amp)</b>	35
<b><math>V_{(BR)}</math> (Volts)</b>	24–32
<b><math>I_{RSM}^{(30)}</math> (Amp)</b>	110
<b><math>T_C</math> @ Rated <math>I_O</math> (°C)</b>	150
<b>T (°C)</b>	175

<sup>(30)</sup> Time constant = 10 ms, duty cycle  $\leq$  1%,  $T_C = 25^\circ\text{C}$ .

Note: MR2535L is considered part of the rectifier product portfolio.




TVS

Axial Leaded for Through-hole Designs (continued)

# Zener Diodes

## Voltage Regulator Diodes

Table 12. Axial Leaded for Through-hole Designs – 500 mW

Nominal Zener Breakdown Voltage	500 mW Cathode = Polarity Band	500 mW Low Level Cathode = Polarity Band	500 mW Cathode = Polarity Band					500 mW Low Level Cathode = Polarity Band	500 mW Cathode = Polarity Band	
			(*Note 4)	(*Note 5)	(*Note 6)	(*Note 7)	(*Note 8)		(*Note 9)	(*Note 10)
 <p>Glass Case 299 DO-204AH (DO-35)</p>										
Volts										
1.8		1N4678						MZ4614		
2.0		1N4679						MZ4615		
2.2		1N4680						MZ4616		
2.4	1N4370A	1N4681	1N5221B	1N5985B	BZX55C2V4RL	BZX79C2V4RL		MZ4617		
2.5			1N5222B							
2.7	1N4371A	1N4682	1N5223B	1N5986B	BZX55C2V7RL	BZX79C2V7RL	BZX83C2V7RL	MZ4618		ZPD2.7RL
2.8			1N5224B							
3.0	1N4372A	1N4683	1N5225B	1N5987B	BZX55C3V0RL	BZX79C3V0RL	BZX83C3V0RL	MZ4619		ZPD3.0RL
3.3	<b>1N746A</b>	1N4684	<b>1N5226B</b>	1N5988B	BZX55C3V3RL	BZX79C3V3RL	BZX83C3V3RL	MZ4620		ZPD3.3RL
3.6	1N747A	1N4685	1N5227B	1N5989B	BZX55C3V6RL	BZX79C3V6RL	BZX83C3V6RL	MZ4621		ZPD3.6RL
3.9	1N748A	1N4686	<b>1N5228B</b>	1N5990B	BZX55C3V9RL	BZX79C3V9RL	BZX83C3V9RL	MZ4622	MZ5520B	ZPD3.9RL
4.3	1N749A	1N4687	1N5229B	1N5991B	BZX55C4V3RL	BZX79C4V3RL	BZX83C4V3RL	MZ4623	MZ5521B	ZPD4.3RL
4.7	1N750A	<b>1N4688</b>	1N5230B	1N5992B	BZX55C4V7RL	BZX79C4V7RL	BZX83C4V7RL	MZ4624	MZ5522B	ZPD4.7RL
5.1	<b>1N751A</b>	1N4689	<b>1N5231B</b>	<b>1N5993B</b>	BZX55C5V1RL	BZX79C5V1RL	BZX83C5V1RL	MZ4625	MZ5523B	ZPD5.1RL
5.6	<b>1N752A</b>	1N4690	<b>1N5232B</b>	<b>1N5994B</b>	BZX55C5V6RL	BZX79C5V6RL	BZX83C5V6RL	MZ4626	MZ5524B	ZPD5.6RL
6.0			1N5233B							
6.2	<b>1N753A</b>	1N4691	<b>1N5234B</b>	1N5995B	BZX55C6V2RL	BZX79C6V2RL	BZX83C6V2RL	MZ4627	MZ5525B	ZPD6.2RL
6.8	1N754A 1N957B	1N4692	<b>1N5235B</b>	1N5996B	BZX55C6V8RL	BZX79C6V8RL	BZX83C6V8RL	MZ4099	MZ5526B	ZPD6.8RL
7.5	1N755A 1N958B	1N4693	1N5236B	1N5997B	BZX55C7V5RL	BZX79C7V5RL	BZX83C7V5RL	MZ4100	MZ5527B	ZPD7.5RL
8.2	1N756A 1N959B	1N4694	<b>1N5237B</b>	<b>1N5998B</b>	BZX55C8V2RL	BZX79C8V2RL	BZX83C8V2RL	MZ4101	MZ5528B	ZPD8.2RL
8.7		1N4695	1N5238B					MZ4102		
9.1	1N757A 1N960B	1N4696	1N5239B	1N5999B	BZX55C9V1RL	BZX79C9V1RL	BZX83C9V1RL	MZ4103	MZ5529B	ZPD9.1RL
10	1N758A 1N961B	1N4697	<b>1N5240B</b>	1N6000B	BZX55C10RL	BZX79C10RL	BZX83C10RL	MZ4104	MZ5530B	ZPD10RL
11	1N962B	1N4698	1N5241B	1N6001B	BZX55C11RL	BZX79C11RL	BZX83C11RL			ZPD11RL
12	1N759A 1N963B	1N4699	<b>1N5242B</b>	1N6002B	BZX55C12RL	BZX79C12RL	BZX83C12RL			ZPD12RL
13	1N964B	1N4700	1N5243B	1N6003B	BZX55C13RL	BZX79C13RL	BZX83C13RL			ZPD13RL
14		1N4701	1N5244B							
15	1N965B	1N4702	<b>1N5245B</b>	1N6004B	BZX55C15RL	BZX79C15RL	BZX83C15RL			ZPD15RL
16	1N966B	1N4703	<b>1N5246B</b>	1N6005B	BZX55C16RL	BZX79C16RL	BZX83C16RL			ZPD16RL
17		1N4704	1N5247B							
18	1N967B	1N4705	1N5248B	1N6006B	BZX55C18RL	BZX79C18RL	BZX83C18RL			ZPD18RL

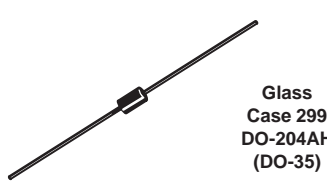
\*See Notes on page NO TAG.

Devices listed in bold, italic are Motorola preferred devices.

# TVS

## Axial Leaded for Through-hole Designs (continued)

Table 12. Axial Leaded for Through-hole Designs – 500 mW (continued)

Nominal Zener Breakdown Voltage	500 mW Cathode = Polarity Band	500 mW Low Level Cathode = Polarity Band	500 mW Cathode = Polarity Band					500 mW Low Level Cathode = Polarity Band	500 mW Cathode = Polarity Band	
			(*Note 4)	(*Note 5)	(*Note 6)	(*Note 7)	(*Note 8)		(*Note 9)	(*Note 10)
Volts										
19		1N4706	1N5249B							
20	1N968B	1N4707	<b>1N5250B</b>	1N6007B	BZX55C20RL	BZX79C20RL	BZX83C20RL			ZPD20RL
22	1N969B	1N4708	1N5251B	1N6008B	BZX55C22RL	BZX79C22RL	BZX83C22RL			ZPD22RL
24	1N970B	1N4709	1N5252B	1N6009B	BZX55C24RL	BZX79C24RL	BZX83C24RL			ZPD24RL
25		1N4710	1N5253B							
27	1N971B	1N4711	1N5254B	1N6010B	BZX55C27RL	BZX79C27RL	BZX83C27RL			ZPD27RL
28		1N4712	1N5255B							
30	1N972B	1N4713	1N5256B	1N6011B	BZX55C30RL	BZX79C30RL	BZX83C30RL			ZPD30RL
33	1N973B	1N4714	1N5257B	1N6012B	BZX55C33RL	BZX79C33RL	BZX83C33RL			ZPD33RL
36	1N974B	1N4715	1N5258B	1N6013B	BZX55C36RL	BZX79C36RL				
39	1N975B	1N4716	1N5259B	1N6014B	BZX55C39RL	BZX79C39RL				
43	1N976B	1N4717	1N5260B	1N6015B	BZX55C43RL	BZX79C43RL				
47	1N977B		1N5261B	1N6016B	BZX55C47RL	BZX79C47RL				
51	1N978B		1N5262B	1N6017B	BZX55C51RL	BZX79C51RL				
56	1N979B		1N5263B	1N6018B	BZX55C56RL	BZX79C56RL				
60			1N5264B							
62	1N980B		1N5265B	1N6019B	BZX55C62RL	BZX79C62RL				
68	1N981B		1N5266B	1N6020B	BZX55C68RL	BZX79C68RL				
75	1N982B		1N5267B	1N6021B	BZX55C75RL	BZX79C75RL				
82	1N983B		1N5268B	1N6022B	BZX55C82RL	BZX79C82RL				
87			1N5269B							
91	1N984B		1N5270B	1N6023B	BZX55C91RL	BZX79C91RL				
100	1N985B		1N5271B	1N6024B		BZX79C100RL				
110	1N986B		1N5272B	1N6025B		BZX79C110RL				
120	1N987B		1N5273B			BZX79C120RL				
130	1N988B		1N5274B			BZX79C130RL				
140			1N5275B							
150	1N989B		1N5276B			BZX79C150RL				
160	1N990B		1N5277B			BZX79C160RL				
170			1N5278B							
180	1N991B		1N5279B			BZX79C180RL				
190			1N5280B							
200	1N992B		1N5281B			BZX79C200RL				
220										
240										
270										
300										
330										
360										
400										

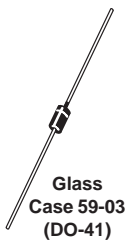
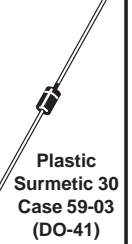


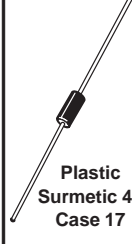
\*See Notes on page NO TAG.

Devices listed in bold, italic are Motorola preferred devices.

# TVS

## Axial Leaded for Through-hole Designs (continued)

Table 13. Axial Leaded for Through-hole Designs – 1, 1.3, 1.5, 3 and 5 Watt

Nominal Zener Breakdown Voltage	1 Watt		1.3 Watt			1.5 Watt	3 Watt	5 Watt
	Cathode = Polarity Band		Cathode = Polarity Band			Cathode = Polarity Band	Cathode = Polarity Band	Cathode = Polarity Band
(*Note 1)	(*Note 11)	(*Note 12)	(*Note 13)	(*Note 14)	(*Note 15)	(*Note 16)	(*Note 17)	(*Note 18)
Volts	 Glass Case 59-03 (DO-41)	 Plastic Surmetic 30 Case 59-03 (DO-41)	 Glass Case 59-03 (DO-41)				 Plastic Surmetic 30 Case 59-03 (DO-41)	 Plastic Surmetic 40 Case 17
3.3	1N4728A	MZP4728A	BZX85C3V3RL			1N5913B		1N5333B
3.6	1N4729A	MZP4729A	<b>BZX85C3V6RL</b>			1N5914B		1N5334B
3.9	1N4730A	MZP4730A	BZX85C3V9RL	MZPY3.9RL	MZD3.9RL	1N5915B	3EZ3.9D5	1N5335B
4.3	1N4731A	MZP4731A	BZX85C4V3RL	MZPY4.3RL	MZD4.3RL	1N5916B	<b>3EZ4.3D5</b>	1N5336B
4.7	1N4732A	MZP4732A	BZX85C4V7RL	MZPY4.7RL	MZD4.7RL	1N5917B	3EZ4.7D5	1N5337B
5.1	<b>1N4733A</b>	MZP4733A	BZX85C5V1RL	MZPY5.1RL	MZD5.1RL	<b>1N5918B</b>	3EZ5.1D5	1N5338B
5.6	<b>1N4734A</b>	MZP4734A	BZX85C5V6RL	MZPY5.6RL	MZD5.6RL	1N5919B	3EZ5.6D5	1N5339B
6.0								1N5340B
6.2	<b>1N4735A</b>	MZP4735A	BZX85C6V2RL	MZPY6.2RL	MZD6.2RL	<b>1N5920B</b>	3EZ6.2D5	1N5341B
6.8	<b>1N4736A</b>	MZP4736A	BZX85C6V8RL	MZPY6.8RL	MZD6.8RL	1N5921B	3EZ6.8D5	1N5342B
7.5	1N4737A	MZP4737A	BZX85C7V5RL	MZPY7.5RL	MZD7.5RL	1N5922B	3EZ7.5D5	1N5343B
8.2	<b>1N4738A</b>	MZP4738A	BZX85C8V2RL	MZPY8.2RL	MZD8.2RL	1N5923B	3EZ8.2D5	1N5344B
8.7								1N5345B
9.1	1N4739A	MZP4739A	BZX85C9V1RL	MZPY9.1RL	MZD9.1RL	1N5924B	3EZ9.1D5	1N5346B
10	<b>1N4740A</b>	MZP4740A	BZX85C10RL	MZPY10RL	MZD10RL	1N5925B	3EZ10D5	1N5347B
11	<b>1N4741A</b>	MZP4741A	BZX85C11RL	MZPY11RL	MZD11RL	1N5926B	3EZ11D5	1N5348B
12	<b>1N4742A</b>	MZP4742A	BZX85C12RL	MZPY12RL	MZD12RL	1N5927B	3EZ12D5	1N5349B
13	1N4743A	MZP4743A	BZX85C13RL	MZPY13RL	MZD13RL	1N5928B	3EZ13D5	1N5350B
14							3EZ14D5	1N5351B
15	<b>1N4744A</b>	MZP4744A	BZX85C15RL	MZPY15RL	MZD15RL	<b>1N5929B</b>	3EZ15D5	1N5352B
16	<b>1N4745A</b>	MZP4745A	BZX85C16RL	MZPY16RL	MZD16RL	1N5930B	3EZ16D5	1N5353B
17							3EZ17D5	1N5354B
18	<b>1N4746A</b>	<b>MZP4746A</b>	BZX85C18RL	MZPY18RL	<b>MZD18RL</b>	1N5931B	3EZ18D5	1N5355B
19							3EZ19D5	1N5356B
20	<b>1N4747A</b>	MZP4747A	BZX85C20RL	MZPY20RL	MZD20RL	1N5932B	3EZ20D5	1N5357B
22	<b>1N4748A</b>	MZP4748A	<b>BZX85C22RL</b>	MZPY22RL	MZD22RL	1N5933B	3EZ22D5	1N5358B
24	<b>1N4749A</b>	<b>MZP4749A</b>	<b>BZX85C24RL</b>	MZPY24RL	MZD24RL	1N5934B	3EZ24D5	1N5359B
25								1N5360B
27	<b>1N4750A</b>	MZP4750A	BZX85C27RL	MZPY27RL	MZD27RL	1N5935B	3EZ27D5	1N5361B
28							3EZ28D5	1N5362B
30	<b>1N4751A</b>	<b>MZP4751A</b>	BZX85C30RL	MZPY30RL	MZD30RL	<b>1N5936B</b>	3EZ30D5	1N5363B
33	<b>1N4752A</b>	MZP4752A	BZX85C33RL	MZPY33RL	MZD33RL	1N5937B	3EZ33D5	1N5364B
36	1N4753A	MZP4753A	BZX85C36RL	MZPY36RL	MZD36RL	1N5938B	3EZ36D5	1N5365B
39	1N4754A	MZP4754A	BZX85C39RL	MZPY39RL	MZD39RL	1N5939B	3EZ39D5	1N5366B
43	1N4755A	MZP4755A	BZX85C43RL	MZPY43RL	MZD43RL	1N5940B	3EZ43D5	1N5367B
47	1N4756A	MZP4756A	BZX85C47RL	MZPY47RL	MZD47RL	1N5941B	3EZ47D5	1N5368B
51	1N4757A	MZP4757A	BZX85C51RL	MZPY51RL	MZD51	1N5942B	3EZ51D5	1N5369B
56	1N4758A	MZP4758A	BZX85C56RL	MZPY56RL	MZD56	1N5943B	3EZ56D5	1N5370B
60								1N5371B
62	1N4759A	MZP4759A	BZX85C62RL	MZPY62RL	MZD62	1N5944B	3EZ62D5	1N5372B
68	1N4760A	MZP4760A	BZX85C68RL	MZPY68RL	MZD68	1N5945B	3EZ68D5	1N5373B


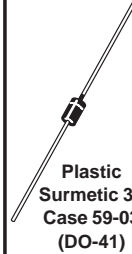


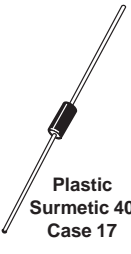
\*See Notes on page NO TAG.

Devices listed in bold, italic are Motorola preferred devices.

# TVS

## Axial Leaded for Through-hole Designs (continued)

Table 13. Axial Leaded for Through-hole Designs – 1, 1.3, 1.5, 3 and 5 Watt (continued)

Nominal Zener Breakdown Voltage	1 Watt Cathode = Polarity Band		1.3 Watt Cathode = Polarity Band			1.5 Watt Cathode = Polarity Band	3 Watt Cathode = Polarity Band	5 Watt Cathode = Polarity Band
	(*Note 1)	(*Note 11)	(*Note 12)	(*Note 13)	(*Note 14)	(*Note 15)	(*Note 16)	(*Note 17)
Volts	 Glass Case 59-03 (DO-41)	 Plastic Surmetic 30 Case 59-03 (DO-41)	 Glass Case 59-03 (DO-41)	 Plastic Surmetic 30 Case 59-03 (DO-41)			 Plastic Surmetic 40 Case 17	
75	1N4761A	MZP4761A	BZX85C75RL	MZPY75RL	MZD75	1N5946B	3EZ75D5	1N5374B
82	1N4762A	MZP4762A	BZX85C82RL	MZPY82RL	MZD82	1N5947B	3EZ82D5	1N5375B
87								1N5376B
91	1N4763A	MZP4763A	BZX85C91RL	MZPY91RL	MZD91	1N5948B	3EZ91D5	1N5377B
100	1N4764A	MZP4764A	BZX85C100RL	MZPY100RL	MZD100	1N5949B	3EZ100D5	1N5378B
110		1M110ZS5			MZD110	1N5950B	3EZ110D5	1N5379B
120		1M120ZS5			MZD120	1N5951B	3EZ120D5	1N5380B
130		1M130ZS5			MZD130	1N5952B	3EZ130D5	1N5381B
140							3EZ140D5	1N5382B
150		1M150ZS5			MZD150	1N5953B	3EZ150D5	1N5383B
160		1M160ZS5			MZD160	1N5954B	3EZ160D5	1N5384B
170							3EZ170D5	1N5385B
180		1M180ZS5			MZD180	<b>1N5955B</b>	3EZ180D5	1N5386B
190							3EZ190D5	1N5387B
200		1M200ZS5			MZD200	1N5956B	3EZ200D5	1N5388B
220							3EZ220D5	
240							3EZ240D5	
270							3EZ270D5	
300							3EZ300D5	
330							3EZ330D5	
360							3EZ360D5	
400							3EZ400D5	

\*See Notes on page NO TAG.

Devices listed in bold, italic are Motorola preferred devices.

## Axial Leaded for Through-hole Designs (continued) Chart

1. Zener Voltage is the key parameter for each device type. It is specified at a particular test current applied at either thermal equilibrium (T.E.) or pulse test condition. The voltage tolerance for the device types listed is, in general,  $\pm 5\%$ ; however, for some series, the voltage tolerance varies from device type to device type over a range of  $\pm(5$  to  $8.5)\%$ . Consult the complete data sheet to determine the exact test conditions and minimum/maximum limits for the zener voltage. Consult Application Note AN924 regarding measurement of Zener Voltage (pulse versus thermal equilibrium).

Power Ratings represent the capability of the case size listed as supplied by Motorola. These ratings may be higher than the JEDEC registration and/or the same device types supplied by other manufacturers.

**V<sub>Z</sub> Test Conditions And Tolerances**




2. 1N4370A/1N746A Series  
 $I_{ZT} = 20$  mA (T.E.).  
 A suffix =  $\pm 5\%$ .  
 C suffix =  $\pm 2\%$ .  
 D suffix =  $\pm 1\%$ .
- 1N957B Series  
 $I_{ZT}$  @ approximately 125 mW point (T.E.).  
 B suffix =  $\pm 5\%$ .  
 C suffix =  $\pm 2\%$ .  
 D suffix =  $\pm 1\%$ .
3. 1N4678 Series  $I_{ZT} = 50$   $\mu$ A (T.E.).  
 No suffix =  $\pm 5\%$ .  
 C suffix =  $\pm 2\%$ .  
 D suffix =  $\pm 1\%$ .  
 Also has delta  $V_Z$  parameter and limit.
4. 1N5221B-42B  $I_{ZT} = 20$  mA (T.E.).  
 1N5243B-81B  $I_{ZT}$  @ approximately 125 mW point (T.E.).  
 B suffix =  $\pm 5\%$ .  
 C suffix =  $\pm 2\%$ .  
 D suffix =  $\pm 1\%$ .
5. 1N5985B-6013B  $I_{ZT} = 5$  mA (T.E.).  
 1N6014B-23B  $I_{ZT} = 2$  mA (T.E.).  
 1N6024B-25B  $I_{ZT} = 1$  mA (T.E.).  
 B suffix =  $\pm 5\%$ .  
 C suffix =  $\pm 2\%$ .  
 D suffix =  $\pm 1\%$ .
6. BZX55C2V4-C36RL  $I_{ZT} = 5$  mA (T.E.).  
 BZX55C39-C82RL  $I_{ZT} = 2.5$  mA (T.E.).  
 BZX55C91RL  $I_{ZT} = 1$  mA (T.E.).  
 C indicates  $\pm(5$  to  $8.5)\%$  depending on type number.  
 Replace C with B for  $\pm 2\%$ .
7. BZX79C2V4-C24RL  $I_{ZT} = 5$  mA (pulse).  
 BZX79C27-C91RL  $I_{ZT} = 2$  mA (pulse).  
 BZX79C100-C200RL  $I_{ZT} = 1$  mA (pulse).  
 C indicates  $\pm(5$  to  $8.5)\%$  depending on type number.  
 Replace C with B for  $\pm 2\%$ .  
 Replace C with A for  $\pm 1\%$ .
8. BZX83C2V7-C33RL  $I_{ZT} = 5$  mA (pulse).  
 ZPD2.7-33RL  $I_{ZT} = 5$  mA (pulse).  
 Tolerance is  $\pm(5$  to  $8.5)\%$  depending on type number.
9. MZ4614-27  $I_{ZT} = 250$   $\mu$ A (T.E.).  
 MZ4099-4104  $I_{ZT} = 250$   $\mu$ A (T.E.).  
 Tolerance is  $\pm 5\%$ .
10. MZ5520B-21B  $I_{ZT} = 20$  mA (T.E.).  
 MZ5522B  $I_{ZT} = 10$  mA (T.E.).  
 MZ5523B  $I_{ZT} = 5$  mA (T.E.).  
 MZ5524B  $I_{ZT} = 3$  mA (T.E.).  
 MZ5525B-30B  $I_{ZT} = 1$  mA (T.E.).  
 Tolerance is  $\pm 5\%$ .  
 Also has delta  $V_Z$  parameter and limit.
11. 1N4728A-64A  
 $I_{ZT}$  @ approximately 250 mW point (T.E.).  
 A suffix =  $\pm 5\%$ .  
 C suffix =  $\pm 2\%$ .  
 D suffix =  $\pm 1\%$ .
12. MZP4728A-64A  
 1M110ZS5-200ZS5  
 $I_{ZT}$  @ approximately 250 mW point (T.E.).  
 MZP Series A suffix =  $\pm 5\%$ .  
 1M Series 5 suffix =  $\pm 5\%$ .
13. BZX85C3V3-C100RL  
 $I_{ZT}$  varies from 185 mW to 300 mW point depending on type number (pulse).  
 C indicates  $\pm(5$  to  $8.5)\%$  depending on type number.  
 Replace C with B for  $\pm 2\%$ .
14. MZPY3.9-8.2RL  $I_{ZT} = 100$  mA (pulse).  
 MZPY9.1-15RL  $I_{ZT} = 50$  mA (pulse).  
 MZPY16-33RL  $I_{ZT} = 25$  mA (pulse).  
 MZPY36-82RL  $I_{ZT} = 10$  mA (pulse).  
 MZPY91-100RL  $I_{ZT} = 5$  mA (pulse).  
 No suffix tolerance is approximately  $\pm(5$  to  $8.5)\%$  depending on type number.  
 C suffix =  $\pm 2\%$ .  
 D suffix =  $\pm 1\%$ .
15. MZD3.9-8.2  $I_{ZT} = 100$  mA (pulse).  
 MZD9.1-15  $I_{ZT} = 50$  mA (pulse).  
 MZD16-33  $I_{ZT} = 25$  mA (pulse).  
 MZD36-82  $I_{ZT} = 10$  mA (pulse).  
 MZD91-200  $I_{ZT} = 5$  mA (pulse).  
 Tolerance is  $\pm(5$  to  $8.5)\%$  depending on type number.
16. 1N5913B-56B  
 $I_{ZT}$  @ approximately 375 mW point (T.E.).  
 B suffix =  $\pm 5\%$ .
17. 3EZ3.9D5-400D5  
 $I_{ZT}$  @ approximately 750 mW point (pulse).  
 Suffix 5 =  $\pm 5\%$ .
18. 1N5333B-88B  
 $I_{ZT}$  varies from 0.9 to 1.5 W point depending on type number (pulse).  
 B suffix =  $\pm 5\%$ .  
 Also has delta  $V_Z$  parameter and limit.

Devices listed in bold, italic are Motorola preferred devices.

# TVS

## Axial Leaded for Through-hole Designs (continued)

Table 14. Surface Mount Packages

Nominal Zener Breakdown Voltage	225 mW Surface Mount		500 mW Surface Mount	500 mW Low Level Surface Mount	500 mW Surface Mount	3 Watt Surface Mount
	SOT-23		SOD-123	SOD-123	SOD-123	SMB
(*Note 1)	(*Note 2)	(*Note 3)	(*Note 4)	(*Note 5)	(*Note 6)	(*Note 7)
Volts	 Anode <span style="margin-left: 100px;">Cathode</span> No Connection Plastic Case 318-07 TO-236AB		 Plastic Case 425, Style 1			 Plastic Case 403A Cathode = Notch
1.8				MMSZ4678T1		
2.0				MMSZ4679T1		
2.2				<b>MMSZ4680T1</b>		
2.4	BZX84C2V4LT1	MMBZ5221BLT1	MMSZ2V4T1	MMSZ4681T1	<b>MMSZ5221BT1</b>	
2.5		MMBZ5222BLT1			<b>MMSZ5222BT1</b>	
2.7	BZX84C2V7LT1	MMBZ5223BLT1	MMSZ2V7T1	MMSZ4682T1	MMSZ5223BT1	
2.8		MMBZ5224BLT1			MMSZ5224BT1	
3.0	BZX84C3V0LT1	MMBZ5225BLT1	MMSZ3V0T1	MMSZ4683T1	<b>MMSZ5225BT1</b>	
3.3	BZX84C3V3LT1	MMBZ5226BLT1	MMSZ3V3T1	MMSZ4684T1	MMSZ5226BT1	1SMB5913BT3
3.6	BZX84C3V6LT1	MMBZ5227BLT1	MMSZ3V6T1	<b>MMSZ4685T1</b>	MMSZ5227BT1	1SMB5914BT3
3.9	BZX84C3V9LT1	<b>MMBZ5228BLT1</b>	MMSZ3V9T1	MMSZ4686T1	MMSZ5228BT1	1SMB5915BT3
4.3	BZX84C4V3LT1	MMBZ5229BLT1	MMSZ4V3T1	MMSZ4687T1	<b>MMSZ5229BT1</b>	1SMB5916BT3
4.7	<b>BZX84C4V7LT1</b>	MMBZ5230BLT1	MMSZ4V7T1	<b>MMSZ4688T1</b>	<b>MMSZ5230BT1</b>	1SMB5917BT3
5.1	<b>BZX84C5V1LT1</b>	<b>MMBZ5231BLT1</b>	<b>MMSZ5V1T1</b>	<b>MMSZ4689T1</b>	<b>MMSZ5231BT1</b>	1SMB5918BT3
5.6	<b>BZX84C5V6LT1</b>	<b>MMBZ5232BLT1</b>	<b>MMSZ5V6T1</b>	<b>MMSZ4690T1</b>	<b>MMSZ5232BT1</b>	1SMB5919BT3
6.0		MMBZ5233BLT1			MMSZ5233BT1	
6.2	<b>BZX84C6V2LT1</b>	<b>MMBZ5234BLT1</b>	<b>MMSZ6V2T1</b>	MMSZ4691T1	<b>MMSZ5234BT1</b>	1SMB5920BT3
6.8	BZX84C6V8LT1	<b>MMBZ5235BLT1</b>	MMSZ6V8T1	MMSZ4692T1	<b>MMSZ5235BT1</b>	1SMB5921BT3
7.5	BZX84C7V5LT1	MMBZ5236BLT1	MMSZ7V5T1	MMSZ4693T1	MMSZ5236BT1	1SMB5922BT3
8.2	BZX84C8V2LT1	MMBZ5237BLT1	MMSZ8V2T1	MMSZ4694T1	MMSZ5237BT1	1SMB5923BT3
8.7		MMBZ5238BLT1		MMSZ4695T1	MMSZ5238BT1	
9.1	BZX84C9V1LT1	MMBZ5239BLT1	MMSZ9V1T1	MMSZ4696T1	MMSZ5239BT1	1SMB5924BT3
10	BZX84C10LT1	<b>MMBZ5240BLT1</b>	MMSZ10T1	MMSZ4697T1	<b>MMSZ5240BT1</b>	1SMB5925BT3
11	BZX84C11LT1	MMBZ5241BLT1	MMSZ11T1	MMSZ4698T1	MMSZ5241BT1	1SMB5926BT3
12	<b>BZX84C12LT1</b>	<b>MMBZ5242BLT1</b>	MMSZ12T1	MMSZ4699T1	<b>MMSZ5242BT1</b>	1SMB5927BT3
13	BZX84C13LT1	MMBZ5243BLT1	MMSZ13T1	MMSZ4700T1	MMSZ5243BT1	1SMB5928BT3
14		MMBZ5244BLT1		MMSZ4701T1	MMSZ5244BT1	
15	BZX84C15LT1	<b>MMBZ5245BLT1</b>	MMSZ15T1	MMSZ4702T1	<b>MMSZ5245BT1</b>	1SMB5929BT3
16	BZX84C16LT1	MMBZ5246BLT1	MMSZ16T1	MMSZ4703T1	<b>MMSZ5246BT1</b>	1SMB5930BT3
17		MMBZ5247BLT1		MMSZ4704T1	MMSZ5247BT1	
18	<b>BZX84C18LT1</b>	<b>MMBZ5248BLT1</b>	<b>MMSZ18T1</b>	MMSZ4705T1	<b>MMSZ5248BT1</b>	1SMB5931BT3
19		MMBZ5249BLT1		MMSZ4706T1	MMSZ5249BT1	
20	BZX84C20LT1	<b>MMBZ5250BLT1</b>	MMSZ20T1	MMSZ4707T1	<b>MMSZ5250BT1</b>	1SMB5932BT3
22	BZX84C22LT1	MMBZ5251BLT1	MMSZ22T1	MMSZ4708T1	MMSZ5251BT1	1SMB5933BT3
24	BZX84C24LT1	MMBZ5252BLT1	MMSZ24T1	MMSZ4709T1	<b>MMSZ5252BT1</b>	1SMB5934BT3
25		MMBZ5253BLT1		MMSZ4710T1	MMSZ5253BT1	
27	BZX84C27LT1	<b>MMBZ5254BLT1</b>	MMSZ27T1	MMSZ4711T1	MMSZ5254BT1	1SMB5935BT3




\*See Notes page NO TAG.

Devices listed in bold, italic are Motorola preferred devices.

# TVS

## Axial Leaded for Through-hole Designs (continued)

Table 14. Surface Mount Packages (continued)

Nominal Zener Breakdown Voltage	225 mW Surface Mount		500 mW Surface Mount	500 mW Low Level Surface Mount	500 mW Surface Mount	3 Watt Surface Mount
	SOT-23		SOD-123	SOD-123	SOD-123	SMB
(*Note 1)	(*Note 2)	(*Note 3)	(*Note 4)	(*Note 5)	(*Note 6)	(*Note 7)
Volts	 Anode Cathode No Connection Plastic Case 318-07 TO-236AB		 Plastic Case 425, Style 1			 Plastic Case 403A Cathode = Notch
28		MMBZ5255BLT1		MMSZ4712T1	MMSZ5255BT1	
30	BZX84C30LT1	MMBZ5256BLT1	MMSZ30T1	MMSZ4713T1	<b>MMSZ5256BT1</b>	1SMB5936BT3
33	BZX84C33LT1	<b>MMBZ5257BLT1</b>	MMSZ33T1	MMSZ4714T1	MMSZ5257BT1	1SMB5937BT3
36	BZX84C36LT1	MMBZ5258BLT1	MMSZ36T1	MMSZ4715T1	MMSZ5258BT1	1SMB5938BT3
39	BZX84C39LT1	MMBZ5259BLT1	<b>MMSZ39T1</b>	MMSZ4716T1	MMSZ5259BT1	1SMB5939BT3
43	BZX84C43LT1	MMBZ5260BLT1	MMSZ43T1	MMSZ4717T1	MMSZ5260BT1	1SMB5940BT3
47	BZX84C47LT1	MMBZ5261BLT1	MMSZ47T1		<b>MMSZ5261BT1</b>	1SMB5941BT3
51	BZX84C51LT1	MMBZ5262BLT1	MMSZ51T1		MMSZ5262BT1	1SMB5942BT3
56	BZX84C56LT1	MMBZ5263BLT1	MMSZ56T1		MMSZ5263BT1	1SMB5943BT3
60		MMBZ5264BLT1			MMSZ5264BT1	
62	BZX84C62LT1	MMBZ5265BLT1	MMSZ62T1		MMSZ5265BT1	1SMB5944BT3
68	BZX84C68LT1	MMBZ5266BLT1	MMSZ68T1		MMSZ5266BT1	1SMB5945BT3
75	BZX84C75LT1	MMBZ5267BLT1	MMSZ75T1		MMSZ5267BT1	1SMB5946BT3
82		MMBZ5268BLT1			MMSZ5268BT1	1SMB5947BT3
87		MMBZ5269BLT1			MMSZ5269BT1	
91		MMBZ5270BLT1			MMSZ5270BT1	1SMB5948BT3
100					MMSZ5271BT1	1SMB5949BT3
110						1SMB5950BT3
120						1SMB5951BT3
130						1SMB5952BT3
150						1SMB5953BT3
160						1SMB5954BT3
170						
180						1SMB5955BT3
200						1SMB5956BT3

\*See Notes on page NO TAG.

Devices listed in bold, italic are Motorola preferred devices.



# TVS

## Axial Leaded for Through-hole Designs (continued) Notes — Surface Mount Chart

1. Zener Voltage is the key parameter for each device type. It is specified at a particular test current applied at either thermal equilibrium (T.E.) or pulse test condition. The voltage tolerance for the device types listed is, in general  $\pm 5\%$ ; however, for some series, the voltage tolerance varies from device type to device type over a range of  $\pm (5 \text{ to } 8.5)\%$ . Consult the complete data sheet to determine the exact test conditions and minimum/maximum limits for the zener voltage.

Power Ratings represent the capability of the case size listed as supplied by Motorola. These ratings may be higher than the same device types supplied by other manufacturers.

\*See Notes on this page.

### **$V_Z$ Test Conditions And Tolerances**

2. **BZX84C2V4L-C24LT1**  $I_{ZT} = 5 \text{ mA}$  (pulse).  
**BZX84C27L-C75LT1**  $I_{ZT} = 2 \text{ mA}$  (pulse).  
Tolerance is  $\pm (5 \text{ to } 8.5)\%$  depending on type number. Each device type also has other  $V_Z$  min/max limits at two other  $I_{ZT}$  pulse current values.

### NOTES — SURFACE MOUNT CHART

1. *Zener Voltage* is the key parameter for each device type. It is specified at a particular test current applied at either thermal equilibrium (T.E.) or pulse test condition. The voltage tolerance for the device types listed is, in general  $\pm 5\%$ ; however, for some series, the voltage tolerance varies from device type to device type over a range of  $\pm (5 \text{ to } 8.5)\%$ . Consult the complete data sheet to determine the exact test conditions and minimum/maximum limits for the zener voltage.

*Power Ratings* represent the capability of the case size listed as supplied by Motorola. These ratings may be higher than the same device types supplied by other manufacturers.

### **$V_Z$ TEST CONDITIONS AND TOLERANCES**

2. **BZX84C2V4L-C24LT1**  $I_{ZT} = 5 \text{ mA}$  (pulse).  
**BZX84C27L-C75LT1**  $I_{ZT} = 2 \text{ mA}$  (pulse).  
Tolerance is  $\pm (5 \text{ to } 8.5)\%$  depending on type number. Each device type also has other  $V_Z$  min/max limits at two other  $I_{ZT}$  pulse current values.

3. **MMBZ5221BL-42BLT1**  $I_{ZT} = 20 \text{ mA}$  (pulse).  
**MMBZ5243BL-70BLT1**  $I_{ZT}$  @ approximately 125 mW point (pulse).  
BL suffix =  $\pm 5\%$ .

4. **MMSZ2V4-24T1**  $I_{ZT} = 5 \text{ mA}$  (pulse).  
**MMSZ27-56T1**  $I_{ZT} = 2 \text{ mA}$  (pulse).  
Tolerance is  $\pm (5 \text{ to } 8.5)\%$  depending on type number. Each device type also has other  $V_Z$  min/max limits at two other  $I_{ZT}$  pulse current values.

5. **MMSZ4678T1 Series**  $I_{ZT} = 50 \mu\text{A}$  (T.E.).  
No suffix =  $\pm 5\%$ .

6. **MMSZ5221B-42BT1**  $I_{ZT} = 20 \text{ mA}$  (T.E.).  
**MMSZ5243B-63BT1**  $I_{ZT}$  @ approximately 125 mW point (T.E.).  
A suffix =  $\pm 10\%$ .  
B suffix =  $\pm 5\%$ .

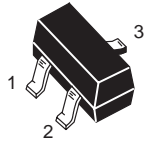
7. **1SMB5913BT3 Series**  $I_{ZT}$  @ approximately 375 mW point (T.E.).  
BT3 suffix =  $\pm 5\%$ .  
T3 suffix designates tape and reel of 2500 units.

Devices listed in bold, italic are Motorola preferred devices.

# TVS

## Axial Leaded for Through-hole Designs (continued)

Table 15. 225 mW Rating on FR-5 Board – Case 318-07 – SOT-23



CASE 318-07, STYLE 8  
SOT-23 (TO-236AB)  
PLASTIC

**ELECTRICAL CHARACTERISTICS (Pinout: 1-Anode, 2-NC, 3-Cathode) ( $V_F = 0.9$  V Max @  $I_F = 10$  mA for all types)**

Type Number	Marking	Zener Voltage $V_{Z1}$ (Volts) @ $I_{ZT1} = 5$ mA (20)			Max Zener Impedance $Z_{ZT1}$ (Ohms) @ $I_{ZT1} = 5$ mA	Max Reverse Leakage Current $I_R$ @ $V_R$ mA Volts	Zener Voltage $V_{Z2}$ (Volts) @ $I_{ZT2} = 1$ mA (20)		Max Zener Impedance $Z_{ZT2}$ (Ohms) @ $I_{ZT2} = 1$ mA	Zener Voltage $V_{Z3}$ (Volts) @ $I_{ZT3} = 20$ mA (20)		Max Zener Impedance $Z_{ZT3}$ (Ohms) @ $I_{ZT3} = 20$ mA	$dV_Z/dt$ (mV/k) @ $I_{ZT1} = 5$ mA		$C_{pF}$ Max @ $V_R = 0$ f = 1 MHz	
		Nom	Min	Max			Min	Max		Min	Max		Min	Max		
BZX84C2V4LT1	Z11	2.4	2.2	2.6	100	50	1	1.7	2.1	600	2.6	3.2	50	-3.5	0	450
BZX84C2V7LT1	Z12	2.7	2.5	2.9	100	20	1	1.9	2.4	600	3	3.6	50	-3.5	0	450
BZX84C3V0LT1	Z13	3	2.8	3.2	95	10	1	2.1	2.7	600	3.3	3.9	50	-3.5	0	450
BZX84C3V3LT1	Z14	3.3	3.1	3.5	95	5	1	2.3	2.9	600	3.6	4.2	40	-3.5	0	450
BZX84C3V6LT1	Z15	3.6	3.4	3.8	90	5	1	2.7	3.3	600	3.9	4.5	40	-3.5	0	450
BZX84C3V9LT1	Z16	3.9	3.7	4.1	90	3	1	2.9	3.5	600	4.1	4.7	30	-3.5	-2.5	450
BZX84C4V3LT1	W9	4.3	4	4.6	90	3	1	3.3	4	600	4.4	5.1	30	-3.5	0	450
<b>BZX84C4V7LT1</b>	Z1	4.7	4.4	5	80	3	2	3.7	4.7	500	4.5	5.4	15	-3.5	0.2	260
<b>BZX84C5V1LT1</b>	Z2	5.1	4.8	5.4	60	2	2	4.2	5.3	480	5	5.9	15	-2.7	1.2	225
<b>BZX84C5V6LT1</b>	Z3	5.6	5.2	6	40	1	2	4.8	6	400	5.2	6.3	10	-2.0	2.5	200
<b>BZX84C6V2LT1</b>	Z4	6.2	5.8	6.6	10	3	4	5.6	6.6	150	5.8	6.8	6	0.4	3.7	185
BZX84C6V8LT1	Z5	6.8	6.4	7.2	15	2	4	6.3	7.2	80	6.4	7.4	6	1.2	4.5	155
BZX84C7V5LT1	Z6	7.5	7	7.9	15	1	5	6.9	7.9	80	7	8	6	2.5	5.3	140
BZX84C8V2LT1	Z7	8.2	7.7	8.7	15	0.7	5	7.6	8.7	80	7.7	8.8	6	3.2	6.2	135
BZX84C9V1LT1	Z8	9.1	8.5	9.6	15	0.5	6	8.4	9.6	100	8.5	9.7	8	3.8	7.0	130
BZX84C10LT1	Z9	10	9.4	10.6	20	0.2	7	9.3	10.6	150	9.4	10.7	10	4.5	8.0	130
BZX84C11LT1	Y1	11	10.4	11.6	20	0.1	8	10.2	11.6	150	10.4	11.8	10	5.4	9.0	130
<b>BZX84C12LT1</b>	Y2	12	11.4	12.7	25	0.1	8	11.2	12.7	150	11.4	12.9	10	6.0	10.0	130
BZX84C13LT1	Y3	13	12.4	14.1	30	0.1	8	12.3	14	170	12.5	14.2	15	7.0	11.0	120
BZX84C15LT1	Y4	15	13.8	15.6	30	0.05	10.5	13.7	15.5	200	13.9	15.7	20	9.2	13.0	110
BZX84C16LT1	Y5	16	15.3	17.1	40	0.05	11.2	15.2	17	200	15.4	17.2	20	10.4	14.0	105
<b>BZX84C18LT1</b>	Y6	18	16.8	19.1	45	0.05	12.6	16.7	19	225	16.9	19.2	20	12.4	16.0	100
BZX84C20LT1	Y7	20	18.8	21.2	55	0.05	14	18.7	21.1	225	18.9	21.4	20	14.4	18.0	85
BZX84C22LT1	Y8	22	20.8	23.3	55	0.05	15.4	20.7	23.2	250	20.9	23.4	25	16.4	20.0	85
BZX84C24LT1	Y9	24	22.8	25.6	70	0.05	16.8	22.7	25.5	250	22.9	25.7	25	18.4	22.0	80
		$V_{Z1}$ Below @ $I_{ZT1} = 2$ mA			$Z_{ZT1}$ Below @ $I_{ZT1} = 2$ mA			$V_{Z2}$ Below @ $I_{ZT2} = 0.1$ mA		$Z_{ZT2}$ Below @ $I_{ZT2} = 0.5$ mA (23)	$V_{Z3}$ Below @ $I_{ZT3} = 10$ mA		$Z_{ZT3}$ Below @ $I_{ZT3} = 10$ mA	$dV_Z/dt$ (mV/k) Below @ $I_{ZT1} = 2$ mA		
BZX84C27LT1	Y10	27	25.1	28.9	80	0.05	18.9	25	28.9	300	25.2	29.3	45	21.4	25.3	70
BZX84C30LT1	Y11	30	28	32	80	0.05	21	27.8	32	300	28.1	32.4	50	24.4	29.4	70
BZX84C33LT1	Y12	33	31	35	80	0.05	23.1	30.8	35	325	31.1	35.4	55	27.4	33.4	70
BZX84C36LT1	Y13	36	34	38	90	0.05	25.2	33.8	38	350	34.1	38.4	60	30.4	37.4	70
BZX84C39LT1	Y14	39	37	41	130	0.05	27.3	36.7	41	350	37.1	41.5	70	33.4	41.2	45
BZX84C43LT1	Y15	43	40	46	150	0.05	30.1	39.7	46	375	40.1	46.5	80	37.6	46.6	40
BZX84C47LT1	Y16	47	44	50	170	0.05	32.9	43.7	50	375	44.1	50.5	90	42.0	51.8	40
BZX84C51LT1	Y17	51	48	54	180	0.05	35.7	47.6	54	400	48.1	54.6	100	46.6	57.2	40
BZX84C56LT1	Y18	56	52	60	200	0.05	39.2	51.5	60	425	52.1	60.8	110	52.2	63.8	40
BZX84C62LT1	Y19	62	58	66	215	0.05	43.4	57.4	66	450	58.2	67	120	58.8	71.6	35
BZX84C68LT1	Y20	68	64	72	240	0.05	47.6	63.4	72	475	64.2	73.2	130	65.6	79.8	35
BZX84C75LT1	Y21	75	70	79	255	0.05	52.5	69.4	79	500	70.3	80.2	140	73.4	88.6	35

(20)  $V_Z$  is measured with a pulse test current ( $I_{ZT}$ ) applied at an ambient temperature of 25°C.

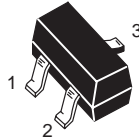

(23) The zener impedance,  $Z_{ZT2}$ , for the 27 through 75 volt types is tested at 0.5 mA rather than the test current of 0.1 mA used for  $V_{Z2}$ .

Devices listed in bold, italic are Motorola preferred devices.

# TVS

## Axial Leaded for Through-hole Designs (continued)

Table 16. 225 mW Rating on FR-5 Board – Case 318-07 – SOT-23

 							
CASE 318-07, STYLE 8 SOT-23 (TO-236AB) PLASTIC							
ELECTRICAL CHARACTERISTICS (Pinout: 1-Anode, 2-NC, 3-Cathode) ( $V_F = 0.9\text{ V Max @ } I_F = 10\text{ mA}$ for all types.)							
Device	Marking	Test Current $I_{ZT}$ mA	Zener Voltage $V_Z (\pm 5\%)$ Nominal (20)	$Z_{ZK}$ $I_Z = 0.25\text{ mA}$ $\Omega$ Max	$Z_{ZT}$ $I_Z = I_{ZT}$ @ 10% Mode $\Omega$ Max	Max $I_R$ $\mu\text{A}$	@ $V_R$ V
MMBZ5221BLT1	18A	20	2.4	1200	30	100	1
MMBZ5222BLT1	18B	20	2.5	1250	30	100	1
MMBZ5223BLT1	18C	20	2.7	1300	30	75	1
MMBZ5224BLT1	18D	20	2.8	1400	30	75	1
MMBZ5225BLT1	18E	20	3	1600	29	50	1
MMBZ5226BLT1	8A	20	3.3	1600	28	25	1
MMBZ5227BLT1	8B	20	3.6	1700	24	15	1
<b>MMBZ5228BLT1</b>	8C	20	3.9	1900	23	10	1
MMBZ5229BLT1	8D	20	4.3	2000	22	5	1
MMBZ5230BLT1	8E	20	4.7	1900	19	5	2
<b>MMBZ5231BLT1</b>	8F	20	5.1	1600	17	5	2
<b>MMBZ5232BLT1</b>	<b>8G</b>	20	5.6	1600	11	5	3
MMBZ5233BLT1	8H	20	6	1600	7	5	3.5
<b>MMBZ5234BLT1</b>	8J	20	6.2	1000	7	5	4
<b>MMBZ5235BLT1</b>	8K	20	6.8	750	5	3	5
MMBZ5236BLT1	8L	20	7.5	500	6	3	6
MMBZ5237BLT1	8M	20	8.2	500	8	3	6.5
MMBZ5238BLT1	8N	20	8.7	600	8	3	6.5
MMBZ5239BLT1	8P	20	9.1	600	10	3	7
<b>MMBZ5240BLT1</b>	8Q	20	10	600	17	3	8
MMBZ5241BLT1	8R	20	11	600	22	2	8.4
<b>MMBZ5242BLT1</b>	8S	20	12	600	30	1	9.1
MMBZ5243BLT1	8T	9.5	13	600	13	0.5	9.9
MMBZ5244BLT1	8U	9	14	600	15	0.1	10
<b>MMBZ5245BLT1</b>	8V	8.5	15	600	16	0.1	11
MMBZ5246BLT1	8W	7.8	16	600	17	0.1	12
MMBZ5247BLT1	8X	7.4	17	600	19	0.1	13
<b>MMBZ5248BLT1</b>	8Y	7	18	600	21	0.1	14
MMBZ5249BLT1	8Z	6.6	19	600	23	0.1	14
<b>MMBZ5250BLT1</b>	81A	6.2	20	600	25	0.1	15
MMBZ5251BLT1	81B	5.6	22	600	29	0.1	17
MMBZ5252BLT1	81C	5.2	24	600	33	0.1	18
MMBZ5253BLT1	81D	5	25	600	35	0.1	19
<b>MMBZ5254BLT1</b>	81E	4.6	27	600	41	0.1	21
MMBZ5255BLT1	81F	4.5	28	600	44	0.1	21
MMBZ5256BLT1	81G	4.2	30	600	49	0.1	23
<b>MMBZ5257BLT1</b>	81H	3.8	33	700	58	0.1	25
MMBZ5258BLT1	81J	3.4	36	700	70	0.1	27
MMBZ5259BLT1	81K	3.2	39	800	80	0.1	30
MMBZ5260BLT1	81L	3	43	900	93	0.1	33

(20)  $V_Z$  is measured at pulse test current ( $I_{ZT}$ ) at an ambient temperature of 25°C.

Devices listed in bold, italic are Motorola preferred devices.

# TVS

## Axial Leaded for Through-hole Designs (continued)

Table 16. 225 mW Rating on FR-5 Board – Case 318-07 – SOT-23 (continued)

ELECTRICAL CHARACTERISTICS (Pinout: 1-Anode, 2-NC, 3-Cathode) ( $V_F = 0.9$ V Max @ $I_F = 10$ mA for all types.)							
Device	Marking	Test Current $I_{ZT}$ mA	Zener Voltage $V_Z (\pm 5\%)$ Nominal (20)	$Z_{ZK}$ $I_Z = 0.25$ mA $\Omega$ Max	$Z_{ZT}$ $I_Z = I_{ZT}$ @ 10% Mode $\Omega$ Max	Max $I_R$ $\mu$ A	@ $V_R$ V
MMBZ5261BLT1	81M	2.7	47	1000	105	0.1	36
MMBZ5262BLT1	81N	2.5	51	1100	125	0.1	39
MMBZ5263BLT1	81P	2.2	56	1300	150	0.1	43
MMBZ5264BLT1	81Q	2.1	60	1400	170	0.1	46
MMBZ5265BLT1	81R	2	62	1400	185	0.1	47
MMBZ5266BLT1	81S	1.8	68	1600	230	0.1	52
MMBZ5267BLT1	81T	1.7	75	1700	270	0.1	56
MMBZ5268BLT1	81U	1.5	82	2000	330	0.1	62
MMBZ5269BLT1	81V	1.4	87	2200	370	0.1	68
MMBZ5270BLT1	81W	1.4	91	2300	400	0.1	69

Table 17. 500 mW Rating on FR-4 or FR-5 Board – Case 425 – SOD-123



ELECTRICAL CHARACTERISTICS ( $T_A = 25^\circ\text{C}$  unless otherwise noted(24), ( $V_F = 0.9$  V Max. @  $I_F = 10$  mA for all types)

Type Number	Marking	Zener Voltage $V_Z @ I_{ZT}$ Volts(24)(25)			Test Voltage $V_R$ Volts	Max Zener Impedance(21)		Max Reverse Leakage Current $I_R @ V_R$ $\mu$ A	Test Voltage $V_R$ Volts
		Nom	Min	Max		$Z_{ZT}$ @ $t_Z = I_{ZT}$ $\Omega$	$Z_{ZK}$ @ $t_{ZK} = 0.25$ mA $\Omega$		
<b>MMSZ5221BT1</b>	C1	2.4	2.28	2.52	20	30	1200	100	1
<b>MMSZ5222BT1</b>	C2	2.5	2.38	2.63	20	30	1250	100	1
MMSZ5223BT1	C3	2.7	2.57	2.84	20	30	1300	75	1
MMSZ5224BT1	C4	2.8	2.66	2.94	20	30	1400	75	1
<b>MMSZ5225BT1</b>	C5	3.0	2.85	3.15	20	30	1600	50	1
MMSZ5226BT1	D1	3.3	3.14	3.47	20	28	1600	25	1
MMSZ5227BT1	D2	3.6	3.42	3.78	20	24	1700	15	1
MMSZ5228BT1	D3	3.9	3.71	4.10	20	23	1900	10	1
<b>MMSZ5229BT1</b>	D4	4.3	4.09	4.52	20	22	2000	5	1
<b>MMSZ5230BT1</b>	D5	4.7	4.47	4.94	20	19	1900	5	2

(20)  $V_Z$  is measured at pulse test current ( $I_{ZT}$ ) at an ambient temperature of  $25^\circ\text{C}$ .  
 (21)  $Z_{ZT}$  and  $Z_{ZK}$  are measured by dividing the AC voltage drop across the device by the AC current applied.  
 The specified limits are for  $I_{Z(AC)} = 0.1 I_{Z(DC)}$ , with the AC frequency = 1 kHz.  
 (24) Nominal zener voltage is measured with the device junction in thermal equilibrium at  $T_L = 30^\circ\text{C} \pm 1^\circ\text{C}$ .  
 (25) All part numbers shown indicate a  $V_Z$  tolerance of  $\pm 5\%$ .

Devices listed in bold, italic are Motorola preferred devices.

# TVS

## Axial Leaded for Through-hole Designs (continued)

Table 17. 500 mW Rating on FR-4 or FR-5 Board – Case 425 – SOD-123 (continued)

ELECTRICAL CHARACTERISTICS ( $T_A = 25^\circ\text{C}$ unless otherwise noted <sup>(24)</sup> , ( $V_F = 0.9\text{ V Max. @ } I_F = 10\text{ mA}$ for all types)									
Type Number	Marking	Zener Voltage $V_Z @ I_{ZT}$ Volts <sup>(24)</sup> <sup>(25)</sup>			Test Voltage $V_R$ Volts	Max Zener Impedance <sup>(21)</sup>		Max Reverse Leakage Current $I_R @ V_R$ $\mu\text{A}$	Test Voltage $V_R$ Volts
		Nom	Min	Max		$Z_{ZT}$ $@ I_Z = I_{ZT}$ $\Omega$	$Z_{ZK}$ $@ I_{ZK} = 0.25\text{ mA}$ $\Omega$		
<b>MMSZ5231BT1</b>	E1	5.1	4.85	5.36	20	17	1600	5	2
<b>MMSZ5232BT1</b>	E2	5.6	5.32	5.88	20	11	1600	5	3
MMSZ5233BT1	E3	6.0	5.70	6.30	20	7	1600	5	3.5
<b>MMSZ5234BT1</b>	E4	6.2	5.89	6.51	20	7	1000	5	4
<b>MMSZ5235BT1</b>	E5	6.8	6.46	7.14	20	5	750	3	5
MMSZ5236BT1	F1	7.5	7.13	7.88	20	6	500	3	6
MMSZ5237BT1	F2	8.2	7.79	8.61	20	8	500	3	6.5
MMSZ5238BT1	F3	8.7	8.27	9.14	20	8	600	3	6.5
MMSZ5239BT1	F4	9.1	8.65	9.56	20	10	600	3	7
<b>MMSZ5240BT1</b>	F5	10	9.50	10.50	20	17	600	3	8
MMSZ5241BT1	H1	11	10.45	11.55	20	22	600	2	8.4
<b>MMSZ5242BT1</b>	H2	12	11.40	12.60	20	30	600	1	9.1
MMSZ5243BT1	H3	13	12.35	13.65	9.5	13	600	0.5	9.9
MMSZ5244BT1	H4	14	13.30	14.70	9.0	15	600	0.1	10
<b>MMSZ5245BT1</b>	H5	15	14.25	15.75	8.5	16	600	0.1	11
<b>MMSZ5246BT1</b>	J1	16	15.20	16.80	7.8	17	600	0.1	12
MMSZ5247BT1	J2	17	16.15	17.85	7.4	19	600	0.1	13
<b>MMSZ5248BT1</b>	J3	18	17.10	18.90	7.0	21	600	0.1	14
MMSZ5249BT1	J4	19	18.05	19.95	6.6	23	600	0.1	14
<b>MMSZ5250BT1</b>	J5	20	19.00	21.00	6.2	25	600	0.1	15
MMSZ5251BT1	K1	22	20.90	23.10	5.6	29	600	0.1	17
<b>MMSZ5252BT1</b>	K2	24	22.80	25.20	5.2	33	600	0.1	18
MMSZ5253BT1	K3	25	23.75	26.25	5.0	35	600	0.1	19
<b>MMSZ5254BT1</b>	K4	27	25.65	28.35	4.6	41	600	0.1	21
MMSZ5255BT1	K5	28	26.60	29.40	4.5	44	600	0.1	21
<b>MMSZ5256BT1</b>	M1	30	28.50	31.50	4.2	49	600	0.1	23
MMSZ5257BT1	M2	33	31.35	34.65	3.8	58	700	0.1	25
MMSZ5258BT1	M3	36	34.20	37.80	3.4	70	700	0.1	27
MMSZ5259BT1	M4	39	37.05	40.95	3.2	80	800	0.1	30
MMSZ5260BT1	M5	43	40.85	45.15	3.0	93	900	0.1	33
<b>MMSZ5261BT1</b>	N1	47	44.65	49.35	2.7	105	1000	0.1	36
MMSZ5262BT1	N2	51	48.45	53.55	2.5	125	1100	0.1	39
MMSZ5263BT1	N3	56	53.20	58.80	2.2	150	1300	0.1	43
MMSZ5264BT1	N4	60	57.00	63.00	2.1	170	1400	0.1	46
MMSZ5265BT1	N5	62	58.90	65.10	2.0	185	1400	0.1	47
MMSZ5266BT1	P1	68	64.60	71.40	1.8	230	1600	0.1	52
MMSZ5267BT1	P2	75	71.25	78.75	1.7	270	1700	0.1	56
MMSZ5268BT1	P3	82	77.90	86.10	1.5	330	2000	0.1	62
MMSZ5269BT1	P4	87	82.65	91.35	1.4	370	2200	0.1	68
MMSZ5270BT1	P5	91	86.45	95.55	1.4	400	2300	0.1	69

<sup>(21)</sup>  $Z_{ZT}$  and  $Z_{ZK}$  are measured by dividing the AC voltage drop across the device by the AC current applied.

The specified limits are for  $I_Z(\text{AC}) = 0.1 I_Z(\text{DC})$ , with the AC frequency = 1 kHz.

<sup>(24)</sup> Nominal zener voltage is measured with the device junction in thermal equilibrium at  $T_L = 30^\circ\text{C} \pm 1^\circ\text{C}$ .

<sup>(25)</sup> All part numbers shown indicate a  $V_Z$  tolerance of  $\pm 5\%$ .

Devices listed in bold, italic are Motorola preferred devices.

# TVS

**Axial Leaded for Through-hole Designs (continued)**  
**Table 18. 500 mW Rating on FR-4 or FR-5 Board – Case 425 – SOD-123**

ELECTRICAL CHARACTERISTICS ( $T_A = 25^\circ\text{C}$ unless otherwise noted <sup>(24)</sup> , ( $V_F = 0.9\text{ V Max. @ } I_F = 10\text{ mA}$ for all types)						
Type Number	Marking	Zener Voltage $V_Z @ I_{ZT} = 50\ \mu\text{A}$ Volts <sup>(24)(25)</sup>			Max Reverse Leakage Current $I_R @ V_R$ $\mu\text{A}$	Test Voltage $V_R$ Volts
		Nom	Min	Max		
MMSZ4678T1	CC	1.8	1.71	1.89	7.5	1
MMSZ4679T1	CD	2.0	1.90	2.10	5	1
<b>MMSZ4680T1</b>	CE	2.2	2.09	2.31	4	1
MMSZ4681T1	CF	2.4	2.28	2.52	2	1
MMSZ4682T1	CH	2.7	2.57	2.84	1	1
MMSZ4683T1	CJ	3.0	2.85	3.15	0.8	1
MMSZ4684T1	CK	3.3	3.14	3.47	7.5	1.5
<b>MMSZ4685T1</b>	CM	3.6	3.42	3.78	7.5	2
MMSZ4686T1	CN	3.9	3.71	4.10	5	2
MMSZ4687T1	CP	4.3	4.09	4.52	4	2
<b>MMSZ4688T1</b>	CT	4.7	4.47	4.94	10	3
<b>MMSZ4689T1</b>	CU	5.1	4.85	5.36	10	3
<b>MMSZ4690T1</b>	CV	5.6	5.32	5.88	10	4
MMSZ4691T1	CA	6.2	5.89	6.51	10	5
MMSZ4692T1	CX	6.8	6.46	7.14	10	5.1
MMSZ4693T1	CY	7.5	7.13	7.88	10	5.7
MMSZ4694T1	CZ	8.2	7.79	8.61	1	6.2
MMSZ4695T1	DC	8.7	8.27	9.14	1	6.6
MMSZ4696T1	DD	9.1	8.65	9.56	1	6.9
MMSZ4697T1	DE	10	9.50	10.50	1	7.6
MMSZ4698T1	DF	11	10.45	11.55	0.05	8.4
MMSZ4699T1	DH	12	11.40	12.60	0.05	9.1
MMSZ4700T1	DJ	13	12.35	13.65	0.05	9.8
MMSZ4701T1	DK	14	13.30	14.70	0.05	10.6
MMSZ4702T1	DM	15	14.25	15.75	0.05	11.4
MMSZ4703T1	DN	16	15.20	16.80	0.05	12.1
MMSZ4704T1	DP	17	16.15	17.85	0.05	12.9
MMSZ4705T1	DT	18	17.10	18.90	0.05	13.6
MMSZ4706T1	DU	19	18.05	19.95	0.05	14.4
MMSZ4707T1	DV	20	19.00	21.00	0.01	15.2
MMSZ4708T1	DA	22	20.90	23.10	0.01	16.7
MMSZ4709T1	DZ	24	22.80	25.20	0.01	18.2
MMSZ4710T1	DY	25	23.75	26.25	0.01	19.00
MMSZ4711T1	EA	27	25.65	28.35	0.01	20.4
MMSZ4712T1	EC	28	26.60	29.40	0.01	21.2
MMSZ4713T1	ED	30	28.50	31.50	0.01	22.8
MMSZ4714T1	EE	33	31.35	34.65	0.01	25.0
MMSZ4715T1	EF	36	34.20	37.80	0.01	27.3
MMSZ4716T1	EH	39	37.05	40.95	0.01	29.6
MMSZ4717T1	EJ	43	40.85	45.15	0.01	32.6

<sup>(24)</sup> Nominal zener voltage is measured with the device junction in thermal equilibrium at  $T_L = 30^\circ\text{C} \pm 1^\circ\text{C}$ .

<sup>(25)</sup> All part numbers shown indicate a  $V_Z$  tolerance of  $\pm 5\%$ .

Devices listed in bold, italic are Motorola preferred devices.

# TVS

## Axial Leaded for Through-hole Designs (continued)

Table 19. 500 mW Rating on FR-4 or FR-5 Board — Case 425 — SOD-123

ELECTRICAL CHARACTERISTICS ( $T_A = 25^\circ\text{C}$ unless otherwise noted <sup>(25)</sup> , ( $V_F = 0.9\text{ V Max. @ } I_F = 10\text{ mA}$ for all types)										
Type Number	Marking	Zener Voltage $V_{Z1}$ (Volts) @ $I_{ZT1} = 5\text{ mA}$ (25)(27)			Max Zener Impedance $Z_{ZT1}$ (21) @ $I_{ZT1} = 5\text{ mA}$ $\Omega$	Max Reverse Leakage Current		Zener Voltage $V_{Z2}$ (Volts) @ $I_{ZT2} = 1\text{ mA}$ (27)		Max Zener Impedance $Z_{ZT2}$ (21) @ $I_{ZT1} = 1\text{ mA}$ $\Omega$
		Nom	Min	Max		$I_R$ $\mu\text{A}$	@ $V_R$ Volts	Min	Max	
MMSZ2V4T1	T1	2.4	2.28	2.52	100	50	1	1.7	2.1	600
MMSZ2V7T1	T2	2.7	2.57	2.84	100	20	1	1.9	2.4	600
MMSZ3V0T1	T3	3.0	2.85	3.15	95	10	1	2.1	2.7	600
MMSZ3V3T1	T4	3.3	3.14	3.47	95	5	1	2.3	2.9	600
MMSZ3V6T1	T5	3.6	3.42	3.78	90	5	1	2.7	3.3	600
MMSZ3V9T1	U1	3.9	3.71	4.10	90	3	1	2.9	3.5	600
MMSZ4V3T1	U2	4.3	4.09	4.52	90	3	1	3.3	4.0	600
MMSZ4V7T1	U3	4.7	4.47	4.94	80	3	2	3.7	4.7	500
<b>MMSZ5V1T1</b>	U4	5.1	4.85	5.36	60	2	2	4.2	5.3	480
<b>MMSZ5V6T1</b>	U5	5.6	5.32	5.88	40	1	2	4.8	6.0	400
<b>MMSZ6V2T1</b>	V1	6.2	5.89	6.51	10	3	4	5.6	6.6	150
MMSZ6V8T1	V2	6.8	6.46	7.14	15	2	4	6.3	7.2	80
MMSZ7V5T1	V3	7.5	7.13	7.88	15	1	5	6.9	7.9	80
MMSZ8V2T1	V4	8.2	7.79	8.61	15	0.7	5	7.6	8.7	80
MMSZ9V1T1	V5	9.1	8.65	9.56	15	0.5	6	8.4	9.6	100
MMSZ10T1	A1	10	9.50	10.50	20	0.2	7	9.3	10.6	150
MMSZ11T1	A2	11	10.45	11.55	20	0.1	8	10.2	11.6	150
MMSZ12T1	A3	12	11.40	12.60	25	0.1	8	11.2	12.7	150
MMSZ13T1	A4	13	12.35	13.65	30	0.1	8	12.3	14.0	170
MMSZ15T1	A5	15	14.25	15.75	30	0.05	10.5	13.7	15.5	200
MMSZ16T1	X1	16	15.20	16.80	40	0.05	11.2	15.2	17.0	200
<b>MMSZ18T1</b>	X2	18	17.10	18.90	45	0.05	12.6	16.7	19.0	225
MMSZ20T1	X3	20	19.00	21.00	55	0.05	14	18.7	21.1	225
MMSZ22T1	X4	22	20.80	23.10	55	0.05	15.4	20.7	23.2	250
MMSZ24T1	X5	24	22.80	25.20	70	0.05	16.8	22.7	25.5	250

(21)  $Z_{ZT}$  and  $Z_{ZK}$  are measured by dividing the AC voltage drop across the device by the AC current applied.

The specified limits are for  $I_{Z(AC)} = 0.1 I_{Z(DC)}$ , with the AC frequency = 1 kHz.

(24) Nominal zener voltage is measured with the device junction in thermal equilibrium at  $T_L = 30^\circ\text{C} \pm 1^\circ\text{C}$ .

(25) All part numbers shown indicate a  $V_Z$  tolerance of  $\pm 5\%$ .

(27) Zener voltage is measured with the zener current applied for  $PW = 1.0\text{ ms}$ .

Devices listed in bold, italic are Motorola preferred devices.

# TVS

## Axial Leaded for Through-hole Designs (continued)

Table 20. 500 mW Rating on FR-4 or FR-5 Board — Case 425 — SOD-123

Type Number	Marking	Zener Voltage $V_{Z1}$ (Volts) @ $I_{ZT1} = 2 \text{ mA}$ (25)(27)			Max Zener Impedance $Z_{ZT1}$ @ $I_{ZT1} = 2 \text{ mA}$ (21) $\Omega$	Max Reverse Leakage Current		Zener Voltage $V_{Z2}$ (Volts) @ $I_{ZT2} = 0.1 \text{ mA}$ (27)		Max Zener Impedance $Z_{ZT2}$ @ $I_{ZT1} = 0.5 \text{ mA}$ (21)(23) $\Omega$
		Nom	Min	Max		$I_R$ $\mu\text{A}$	@ $V_R$ Volts	Min	Max	
MMSZ27T1	Y1	27	25.65	28.35	80	0.05	18.9	25	28.9	300
MMSZ30T1	Y2	30	28.50	31.50	80	0.05	21	27.8	32	300
MMSZ33T1	Y3	33	31.35	34.65	80	0.05	23.1	30.8	35	325
MMSZ36T1	Y4	36	34.20	37.80	90	0.05	25.2	33.8	38	350
<b><i>MMSZ39T1</i></b>	Y5	39	37.05	40.95	130	0.05	27.3	36.7	41	350
MMSZ43T1	Z1	43	40.85	45.15	150	0.05	30.1	39.7	46	375
MMSZ47T1	Z2	47	44.65	49.35	170	0.05	32.9	43.7	50	375
MMSZ51T1	Z3	51	48.45	53.55	180	0.05	35.7	47.6	54	400
MMSZ56T1	Z4	56	53.20	58.80	200	0.05	39.2	51.5	60	425
MMSZ62T1	Z5	62	58.90	65.10	215	0.05	43.4	57.4	66	450
MMSZ68T1	Z6	68	64.60	71.40	240	0.05	47.6	63.4	72	475
MMSZ75T1	Z7	75	71.25	78.75	255	0.05	52.5	69.4	79	500

(21)  $Z_{ZT}$  and  $Z_{ZK}$  are measured by dividing the AC voltage drop across the device by the AC current applied. The specified limits are for  $I_Z(\text{AC}) = 0.1 I_Z(\text{DC})$ , with the AC frequency = 1 kHz

(23) The zener impedance,  $Z_{ZT2}$ , for the 27 through 75 volt types is tested at 0.5 mA rather than the test current of 0.1 mA used for  $V_{Z2}$ .

(25) All part numbers shown indicate a  $V_Z$  tolerance of  $\pm 5\%$

(27) Zener voltage is measured with the zener current applied for  $PW = 1.0 \text{ ms}$ .

Devices listed in bold, italic are Motorola preferred devices.



# TVS

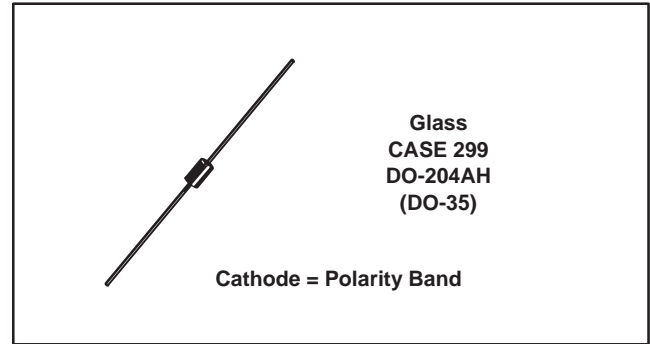
## Axial Leaded for Through-hole Designs (continued)

### Voltage Reference Diodes

#### Temperature Compensated Reference Devices

For applications where output voltage must remain within narrow limits during changes in input voltage, load resistance and temperature. Motorola guarantees all reference devices to fall within the specified maximum voltage variations,  $\Delta V_Z$ , at the specifically indicated test temperatures and test current (JEDEC Standard #5). Temperature coefficient is also specified but should be considered as a reference only — not a maximum rating.

Devices in this table are hermetically sealed structures.



**Table 21. Temperature Compensated Reference Devices**

V <sub>Z</sub> Volts	Test Current mA <sub>DC</sub>	Test(2) Temp Points	AVERAGE TEMPERATURE COEFFICIENT OVER THE OPERATING RANGE									
			0.01 %/°C		0.005 %/°C		0.002 %/°C		0.001 %/°C		0.0005 %/°C	
			Device Type	$\Delta V_Z$ Max Volts	Device Type	$\Delta V_Z$ Max Volts	Device Type	$\Delta V_Z$ Max Volts	Device Type	$\Delta V_Z$ Max Volts	Device Type	$\Delta V_Z$ Max Volts
6.2(1)	7.5	A	<b>1N821</b>	0.096	<b>1N823</b>	0.048	<b>1N825</b>	0.019	1N827	0.009	1N829	0.005
6.2(1)	7.5	A	<b>1N821A</b>	0.096	<b>1N823A</b>	0.048	<b>1N825A</b>	0.019	1N827A	0.009	1N829A	0.005

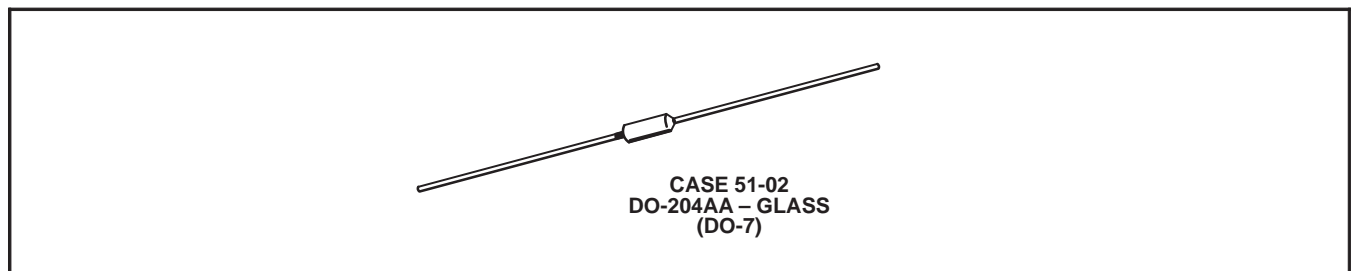
(1) Non-suffix — Z<sub>ZT</sub> = 15 ohms, "A" Suffix — Z<sub>ZT</sub> = 10 ohms

(2) Test Temperature Points °C: A = -55, 0, +25, +75, +100

### Current Regulator Diodes

High impedance diodes whose "constant current source" characteristic complements the "constant voltage" of the zener line. Currents are available from 0.22 to 4.7 mA, with usable voltage range from a minimum limit of 1.0 to 2.5 Volts, up to a voltage compliance of 100 Volts, for the 1N5283 series.

**Table 22. Current Regulator Diodes**



**ELECTRICAL CHARACTERISTICS** (T<sub>A</sub> = 25°C unless otherwise noted)

Type No.	Regulator Current I <sub>P</sub> (mA) @ V <sub>T</sub> = 25 V			Minimum Dynamic Impedance @ V <sub>T</sub> = 25 V Z <sub>T</sub> (MΩ)	Minimum Knee Impedance @ V <sub>K</sub> = 6.0 V Z <sub>K</sub> (MΩ)	Maximum Limiting Voltage @ I <sub>L</sub> = 0.8 I <sub>P</sub> (min) V <sub>L</sub> (Volts)
	Nom	Min	Max			
<b>1N5283</b>	0.22	0.198	0.242	25.0	2.75	1.00
1N5284	0.24	0.216	0.264	19.0	2.35	1.00
1N5285	0.27	0.243	0.297	14.0	1.95	1.00
1N5286	0.30	0.270	0.330	9.0	1.60	1.00
<b>1N5287</b>	0.33	0.297	0.363	6.6	1.35	1.00

Devices listed in bold, italic are Motorola preferred devices.

# TVS

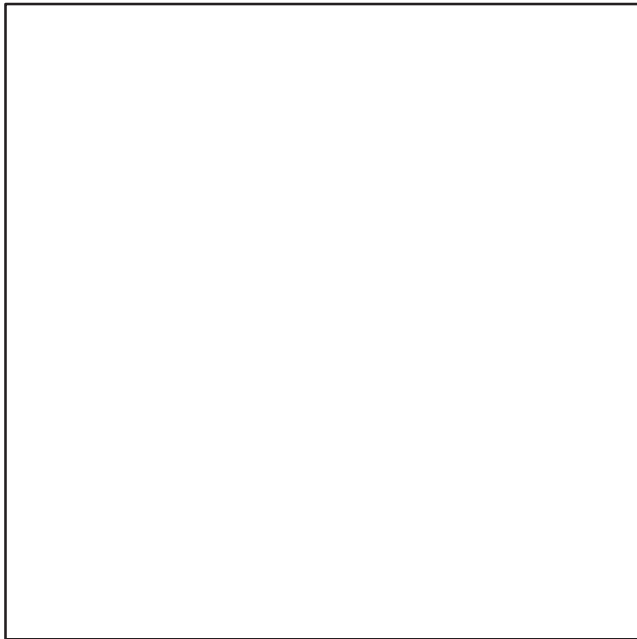
## Axial Leaded for Through-hole Designs (continued)

Table 22. Current Regulator Diodes (continued)

ELECTRICAL CHARACTERISTICS ( $T_A = 25^\circ\text{C}$ unless otherwise noted)						
Type No.	Regulator Current $I_P$ (mA) @ $V_T = 25\text{ V}$			Minimum Dynamic Impedance @ $V_T = 25\text{ V}$ $Z_T$ (M $\Omega$ )	Minimum Knee Impedance @ $V_K = 6.0\text{ V}$ $Z_K$ (M $\Omega$ )	Maximum Limiting Voltage @ $I_L = 0.8 I_P$ (min) $V_L$ (Volts)
	Nom	Min	Max			
1N5288	0.39	0.351	0.429	4.10	1.00	1.05
1N5289	0.43	0.387	0.473	3.30	0.870	1.05
<b>1N5290</b>	0.47	0.423	0.517	2.70	0.750	1.05
<b>1N5291</b>	0.56	0.504	0.616	1.90	0.580	1.10
1N5292	0.62	0.558	0.682	1.55	0.470	1.13
1N5293	0.68	0.612	0.748	1.35	0.400	1.15
1N5294	0.75	0.675	0.825	1.15	0.335	1.20
1N5295	0.82	0.738	0.902	1.00	0.290	1.25
1N5296	0.91	0.819	1.001	0.880	0.240	1.29
<b>1N5297</b>	1.00	0.900	1.100	0.800	0.205	1.35
<b>1N5298</b>	1.10	0.990	1.210	0.700	0.180	1.40
<b>1N5299</b>	1.20	1.08	1.32	0.640	0.155	1.45
1N5300	1.30	1.17	1.43	0.580	0.135	1.50
1N5301	1.40	1.26	1.54	0.540	0.115	1.55
<b>1N5302</b>	1.50	1.35	1.65	0.510	0.105	1.60
1N5303	1.60	1.44	1.76	0.475	0.092	1.65
1N5304	1.80	1.62	1.98	0.420	0.074	1.75
<b>1N5305</b>	2.00	1.80	2.20	0.395	0.061	1.85
<b>1N5306</b>	2.20	1.98	2.42	0.370	0.052	1.95
<b>1N5307</b>	2.40	2.16	2.64	0.345	0.044	2.00
1N5308	2.70	2.43	2.97	0.320	0.035	2.15
<b>1N5309</b>	3.00	2.70	3.30	0.300	0.029	2.25
1N5310	3.30	2.97	3.63	0.280	0.024	2.35
1N5311	3.60	3.24	3.96	0.265	0.020	2.50
<b>1N5312</b>	3.90	3.51	4.29	0.255	0.017	2.60
<b>1N5313</b>	4.30	3.87	4.73	0.245	0.014	2.75
<b>1N5314</b>	4.70	4.23	5.17	0.235	0.012	2.90

Devices listed in bold, italic are Motorola preferred devices.

# Section Four



## Transient Voltage Suppressors — Axial Leaded Data Sheets

4

<b>500 Watt Peak Power</b>	
SA5.0A through SA170A .....	4-2
<b>600 Watt Peak Power</b>	
P6KE6.8A through P6KE200A .....	NO TAG
<b>1500 Watt Peak Power</b>	
General Data — 1500 Watt .....	NO TAG
1N5908 .....	NO TAG
1N6267A through 1N6303A, 1.5KE6.8A through 1.5KE250A .....	NO TAG
1N6373 through 1N6389, ICTE-5 through ICTE-45C and MPTE-5 through MPTE-45C .....	NO TAG
<b>Overvoltage 110 Amp Repetitive Peak</b>	
MR2535L .....	NO TAG

## Zener Transient Voltage Suppressors Unidirectional and Bidirectional

The SA5.0A series is designed to protect voltage sensitive components from high voltage, high energy transients. They have excellent clamping capability, high surge capability, low zener impedance and fast response time. The SA5.0A series is supplied in Motorola's exclusive, cost-effective, highly reliable Surmetic axial leaded package and is ideally-suited for use in communication systems, numerical controls, process controls, medical equipment, business machines, power supplies and many other industrial/consumer applications.

**Specification Features:**

- Stand-off Zener Voltage Range — 5 to 170 V
- Peak Power — 500 Watts @ 1 ms
- Maximum Clamp Voltage @ Peak Pulse Current
- Low Leakage < 1  $\mu$ A Above 8.5 Volts
- Maximum Temperature Coefficient Specified
- Response Time is Typically Less than 1 ns

**Mechanical Characteristics:**

**CASE:** Void-free, transfer-molded, thermosetting plastic

**FINISH:** All external surfaces are corrosion resistant and leads are readily solderable

**POLARITY:** Cathode indicated by polarity band. When operated in zener mode, will be positive with respect to anode

**MOUNTING POSITION:** Any

**WAFER FAB LOCATION:** Phoenix, Arizona

**ASSEMBLY/TEST LOCATION:** Guadalajara, Mexico

**SA5.0A  
 through  
 SA170A**

**MOSORB  
 ZENER OVERVOLTAGE  
 TRANSIENT  
 SUPPRESSORS  
 5-170 VOLT  
 500 WATT PEAK POWER  
 3 WATT STEADY STATE**



**MAXIMUM RATINGS**

Rating	Symbol	Value	Unit
Peak Power Dissipation (1) @ $T_L \leq 25^\circ\text{C}$	$P_{PK}$	500	Watts
Steady State Power Dissipation @ $T_L \leq 75^\circ\text{C}$ , Lead Length = 3/8" Derated above $T_L = 75^\circ\text{C}$	$P_D$	3	Watts
		30	mW/ $^\circ\text{C}$
Forward Surge Current (2) @ $T_A = 25^\circ\text{C}$	$I_{FSM}$	70	Amps
Operating and Storage Temperature Range	$T_J, T_{stg}$	- 55 to +175	$^\circ\text{C}$

Lead Temperature not less than 1/16" from the case for 10 seconds: 230 $^\circ\text{C}$

NOTES: 1. Nonrepetitive current pulse per Figure 4 and derated above  $T_A = 25^\circ\text{C}$  per Figure 2.

2. 1/2 sine wave (or equivalent square wave), PW = 8.3 ms, duty cycle = 4 pulses per minute maximum.

**ELECTRICAL CHARACTERISTICS** ( $T_A = 25^\circ\text{C}$  unless otherwise noted)  $V_F = 3.5\text{ V Max}$ ,  $I_F^* = 35\text{ A}$  (except bidirectional devices).

Device	Breakdown Voltage		@ $I_T$ (mA)	Working Peak Reverse Voltage $V_{RWM}^{**}$ (Volts)	Maximum Reverse Leakage @ $V_{RWM}$ $I_R$ ( $\mu\text{A}$ )	Maximum Reverse Surge Current $I_{RSM}^\dagger$ (Amps)	Maximum Reverse Voltage @ $I_{RSM}$ (Clamping Voltage) $V_{RSM}$ (Volts)	Maximum Voltage Temperature Variation of $V_{BR}$ mV/ $^\circ\text{C}$
	$V_{BR}^{\dagger\dagger}$ (Volts)							
	Min	Max						
SA5.0A	6.4	7	10	5	600	54.3	9.2	5
SA6.0A	6.67	7.37	10	6	600	48.5	10.3	5
SA6.5A	7.22	7.98	10	6.5	400	44.7	11.2	5
SA7.0A	7.78	8.6	10	7	150	41.7	12	6
SA7.5A	8.33	9.21	1	7.5	50	38.8	12.9	7
SA8.0A	8.89	9.83	1	8	25	36.7	13.6	7
SA8.5A	9.44	10.4	1	8.5	5	34.7	14.4	8
SA9.0A	10	11.1	1	9	1	32.5	15.4	9
SA10A	11.1	12.3	1	10	1	29.4	17	10
<b>SA11A</b>	<b>12.2</b>	<b>13.5</b>	<b>1</b>	<b>11</b>	<b>1</b>	<b>27.4</b>	<b>18.2</b>	<b>11</b>
SA12A	13.3	14.7	1	12	1	25.1	19.9	12
SA13A	14.4	15.9	1	13	1	23.2	21.5	13
SA14A	15.6	17.2	1	14	1	21.5	23.2	14
SA15A	16.7	18.5	1	15	1	20.6	24.4	16
SA16A	17.8	19.7	1	16	1	19.2	26	17
SA17A	18.9	20.9	1	17	1	18.1	27.6	19
SA18A	20	22.1	1	18	1	17.2	29.2	20
SA20A	22.2	24.5	1	20	1	15.4	32.4	23
SA22A	24.4	26.9	1	22	1	14.1	35.5	25
SA24A	26.7	29.5	1	24	1	12.8	38.9	28
SA26A	28.9	31.9	1	26	1	11.9	42.1	30
SA28A	31.1	34.4	1	28	1	11	45.4	31
SA30A	33.3	36.8	1	30	1	10.3	48.4	36
SA33A	36.7	40.6	1	33	1	9.4	53.3	39
SA36A	40	44.2	1	36	1	8.6	58.1	41
SA40A	44.4	49.1	1	40	1	7.8	64.5	46
SA43A	47.8	52.8	1	43	1	7.2	69.4	50
SA45A	50	55.3	1	45	1	6.9	72.7	52
SA48A	53.3	58.9	1	48	1	6.5	77.4	56
SA51A	56.7	62.7	1	51	1	6.1	82.4	61
SA54A	60	66.3	1	54	1	5.7	87.1	65
SA58A	64.4	71.2	1	58	1	5.3	93.6	70
SA60A	66.7	73.7	1	60	1	5.2	96.8	71
SA64A	71.1	78.6	1	64	1	4.9	103	76
SA70A	77.8	86	1	70	1	4.4	113	85
SA75A	83.3	92.1	1	75	1	4.1	121	91
SA78A	86.7	95.8	1	78	1	4	126	95
SA85A	94.4	104	1	85	1	3.6	137	103
<b>SA90A</b>	<b>100</b>	<b>111</b>	<b>1</b>	<b>90</b>	<b>1</b>	<b>3.4</b>	<b>146</b>	<b>110</b>
SA100A	111	123	1	100	1	3.1	162	123
SA110A	122	135	1	110	1	2.8	177	133
SA120A	133	147	1	120	1	2.5	193	146
SA130A	144	159	1	130	1	2.4	209	158
SA150A	167	185	1	150	1	2.1	243	184
SA160A	178	197	1	160	1	1.9	259	196
SA170A	189	209	1	170	1	1.8	275	208

\* 1/2 sine wave (or equivalent square wave), PW = 8.3 ms, duty cycle = 4 pulses per minute maximum. (continued)

\*\* MOSORB transient suppressors are normally selected according to the maximum reverse stand-off voltage ( $V_{RWM}$ ), which should be equal to or greater than the dc or continuous peak operating voltage level.

† Surge current waveform per Figure 4 and derate per Figure 2.

††  $V_{BR}$  measured at pulse test current  $I_T$  at an ambient temperature of  $25^\circ\text{C}$ .

**FOR BIDIRECTIONAL APPLICATIONS**

**USE CA SUFFIX for SA6.0CA through SA170CA**

**Electrical characteristics apply in both directions.**

**Preferred Bidirectional Devices —**

**SA6.5CA      SA13CA      SA18CA**  
**SA12CA      SA15CA      SA24CA**

Devices listed in bold, italic are Motorola preferred devices.

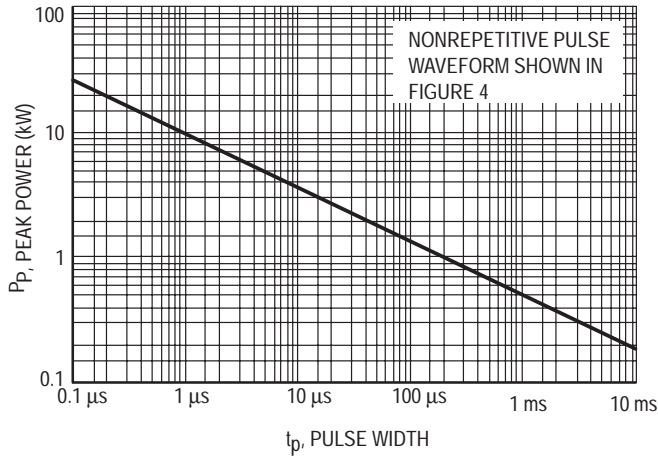


Figure 1. Pulse Rating Curve

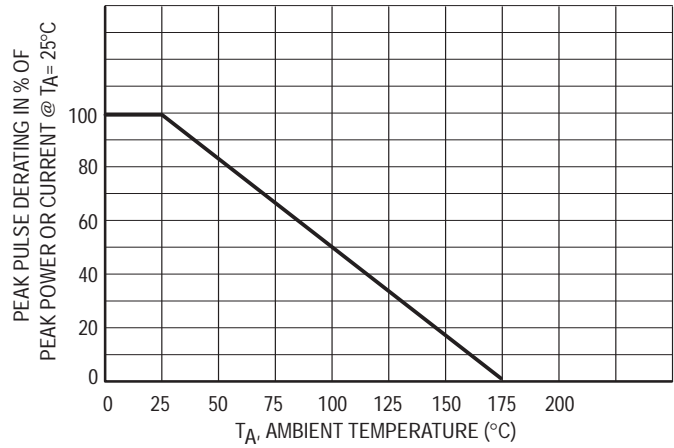


Figure 2. Pulse Derating Curve

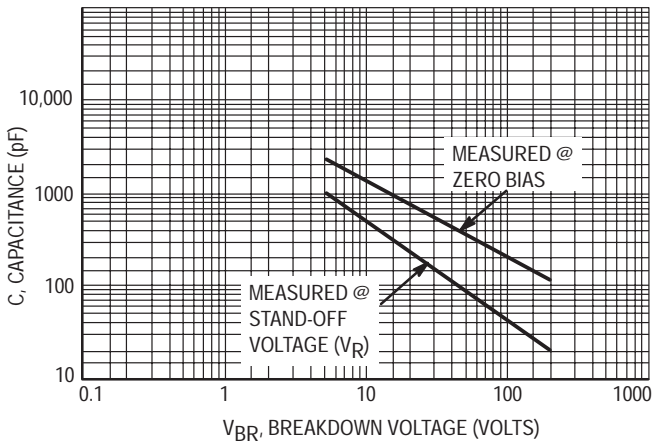


Figure 3. Capacitance versus Breakdown Voltage

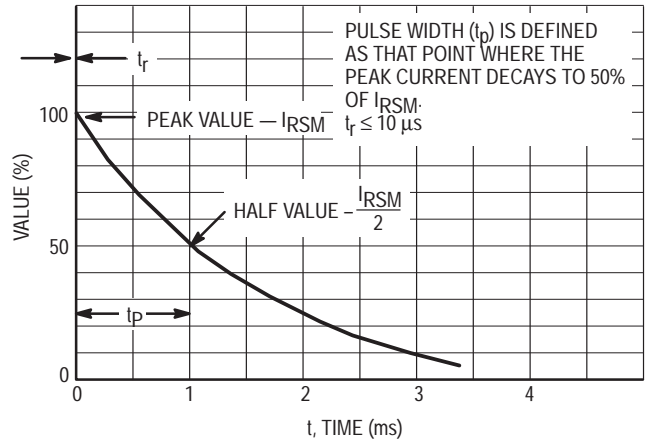


Figure 4. Pulse Waveform

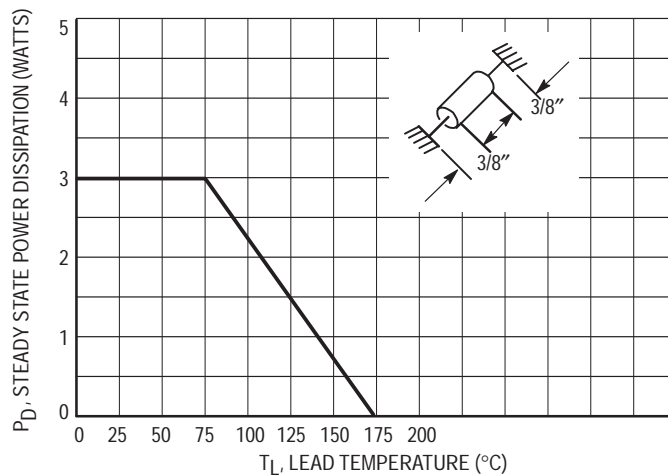
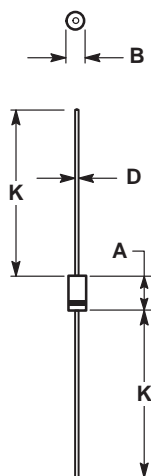


Figure 5. Steady State Power Derating

# Transient Voltage Suppressors — Axial Leaded

## 500 Watt Peak Power



- NOTES:
1. ALL RULES AND NOTES ASSOCIATED WITH JEDEC DO-41 OUTLINE SHALL APPLY.
  2. POLARITY DENOTED BY CATHODE BAND.
  3. LEAD DIAMETER NOT CONTROLLED WITHIN F DIMENSION.

DIM	MILLIMETERS		INCHES	
	MIN	MAX	MIN	MAX
A	5.97	6.60	0.235	0.260
B	2.79	3.05	0.110	0.120
D	0.76	0.86	0.030	0.034
K	27.94	—	1.100	—

**CASE 59-04  
PLASTIC**

(Refer to Section 10 for Surface Mount, Thermal Data and Footprint Information.)

### MULTIPLE PACKAGE QUANTITY (MPQ) REQUIREMENTS

Package Option	Type No. Suffix	MPQ (Units)
Tape and Reel	RL	5K

(Refer to Section 10 for more information on Packaging Specifications.)

Devices listed in bold, italic are Motorola preferred devices.

## Zener Transient Voltage Suppressors Unidirectional and Bidirectional

The P6KE6.8A series is designed to protect voltage sensitive components from high voltage, high energy transients. They have excellent clamping capability, high surge capability, low zener impedance and fast response time. The P6KE6.8A series is supplied in Motorola's exclusive, cost-effective, highly reliable Surmetic axial leaded package and is ideally-suited for use in communication systems, numerical controls, process controls, medical equipment, business machines, power supplies and many other industrial/consumer applications.

### Specification Features:

- Standard Zener Voltage Range — 6.8 to 200 Volts
- Peak Power — 600 Watts @ 1 ms
- Maximum Clamp Voltage @ Peak Pulse Current
- Low Leakage < 5  $\mu$ A Above 10 Volts
- Maximum Temperature Coefficient Specified
- UL Recognition
- Response Time is Typically < 1 ns

### Mechanical Characteristics:

**CASE:** Void-free, transfer-molded, thermosetting plastic

**FINISH:** All external surfaces are corrosion resistant and leads are readily solderable

**POLARITY:** Cathode indicated by polarity band. When operated in zener mode, will be positive with respect to anode

**MOUNTING POSITION:** Any

**WAFER FAB LOCATION:** Phoenix, Arizona

**ASSEMBLY/TEST LOCATION:** Seoul, Korea

**ZENER OVERVOLTAGE  
TRANSIENT  
SUPPRESSORS  
6.8–200 VOLT  
600 WATT PEAK POWER  
5 WATTS STEADY STATE**



**CASE 17, Style 1  
PLASTIC**

### MAXIMUM RATINGS

Rating	Symbol	Value	Unit
Peak Power Dissipation (1) @ $T_L \leq 25^\circ\text{C}$	$P_{PK}$	600	Watts
Steady State Power Dissipation @ $T_L \leq 75^\circ\text{C}$ , Lead Length = 3/8" Derated above $T_L = 75^\circ\text{C}$	$P_D$	5	Watts
		50	mW/ $^\circ\text{C}$
Forward Surge Current (2) @ $T_A = 25^\circ\text{C}$	$I_{FSM}$	100	Amps
Operating and Storage Temperature Range	$T_J, T_{stg}$	- 65 to +175	$^\circ\text{C}$

Lead Temperature not less than 1/16" from the case for 10 seconds: 230 $^\circ\text{C}$

NOTES: 1. Nonrepetitive current pulse per Figure 4 and derated above  $T_A = 25^\circ\text{C}$  per Figure 2.

2. 1/2 sine wave (or equivalent square wave), PW = 8.3 ms, duty cycle = 4 pulses per minute maximum.



**ELECTRICAL CHARACTERISTICS** ( $T_A = 25^\circ\text{C}$  unless otherwise noted)  $V_F = 3.5\text{ V Max}$ ,  $I_F^{**} = 50\text{ A}$   
(except bidirectional devices).

Device	Breakdown Voltage*				Working Peak Reverse Voltage $V_{RWM}$ (Volts)	Maximum Reverse Leakage @ $V_{RWM}$ $I_R$ ( $\mu\text{A}$ )	Maximum Reverse Surge Current $I_{RSM}^\dagger$ (Amps)	Maximum Reverse Voltage @ $I_{RSM}$ (Clamping Voltage) $V_{RSM}$ (Volts)	Maximum Temperature Coefficient of $V_{BR}$ ( $\%/^\circ\text{C}$ )
	$V_{BR}$ (Volts)			@ $I_T$ (mA)					
	Min	Nom	Max						
<b><i>P6KE6.8A</i></b>	6.45	6.8	7.14	10	5.8	1000	57	10.5	0.057
P6KE7.5A	7.13	7.5	7.88	10	6.4	500	53	11.3	0.061
P6KE8.2A	7.79	8.2	8.61	10	7.02	200	50	12.1	0.065
P6KE9.1A	8.65	9.1	9.55	1	7.78	50	45	13.4	0.068
P6KE10A	9.5	10	10.5	1	8.55	10	41	14.5	0.073
P6KE11A	10.5	11	11.6	1	9.4	5	38	15.6	0.075
P6KE12A	11.4	12	12.6	1	10.2	5	36	16.7	0.078
P6KE13A	12.4	13	13.7	1	11.1	5	33	18.2	0.081
<b><i>P6KE15A</i></b>	<b>14.3</b>	<b>15</b>	<b>15.8</b>	<b>1</b>	<b>12.8</b>	<b>5</b>	<b>28</b>	<b>21.2</b>	<b>0.084</b>
P6KE16A	15.2	16	16.8	1	13.6	5	27	22.5	0.086
P6KE18A	17.1	18	18.9	1	15.3	5	24	25.2	0.088
P6KE20A	19	20	21	1	17.1	5	22	27.7	0.09
P6KE22A	20.9	22	23.1	1	18.8	5	20	30.6	0.092
P6KE24A	22.8	24	25.2	1	20.5	5	18	33.2	0.094
P6KE27A	25.7	27	28.4	1	23.1	5	16	37.5	0.096
P6KE30A	28.5	30	31.5	1	25.6	5	14.4	41.4	0.097
P6KE33A	31.4	33	34.7	1	28.2	5	13.2	45.7	0.098
P6KE36A	34.2	36	37.8	1	30.8	5	12	49.9	0.099
P6KE39A	37.1	39	41	1	33.3	5	11.2	53.9	0.1
P6KE43A	40.9	43	45.2	1	36.8	5	10.1	59.3	0.101
P6KE47A	44.7	47	49.4	1	40.2	5	9.3	64.8	0.101
P6KE51A	48.5	51	53.6	1	43.6	5	8.6	70.1	0.102
P6KE56A	53.2	56	58.8	1	47.8	5	7.8	77	0.103
P6KE62A	58.9	62	65.1	1	53	5	7.1	85	0.104
P6KE68A	64.6	68	71.4	1	58.1	5	6.5	92	0.104
P6KE75A	71.3	75	78.8	1	64.1	5	5.8	103	0.105
P6KE82A	77.9	82	86.1	1	70.1	5	5.3	113	0.105
P6KE91A	86.5	91	95.5	1	77.8	5	4.8	125	0.106
P6KE100A	95	100	105	1	85.5	5	4.4	137	0.106
P6KE110A	105	110	116	1	94	5	4	152	0.107
P6KE120A	114	120	126	1	102	5	3.6	165	0.107
P6KE130A	124	130	137	1	111	5	3.3	179	0.107
P6KE150A	143	150	158	1	128	5	2.9	207	0.108
P6KE160A	152	160	168	1	136	5	2.7	219	0.108
P6KE170A	162	170	179	1	145	5	2.6	234	0.108
P6KE180A	171	180	189	1	154	5	2.4	246	0.108
P6KE200A	190	200	210	1	171	5	2.2	274	0.108

\*  $V_{BR}$  measured after  $I_T$  applied for 300  $\mu\text{s}$ ,  $I_T$  = square wave pulse or equivalent.

\*\* 1/2 sine wave (or equivalent square wave),  $PW = 8.3\text{ ms}$ , duty cycle = 4 pulses per minute maximum.

† Surge current waveform per Figure 4 and derate per Figure 2.

**FOR BIDIRECTIONAL APPLICATIONS —**  
**USE CA SUFFIX for P6KE6.8CA through P6KE200CA.**  
Electrical characteristics apply in both directions.

**Preferred Bidirectional Devices —**  
**P6KE7.5CA P6KE11CA P6KE20CA**  
**P6KE22CA P6KE27CA P6KE30CA**

Devices listed in bold, italic are Motorola preferred devices.

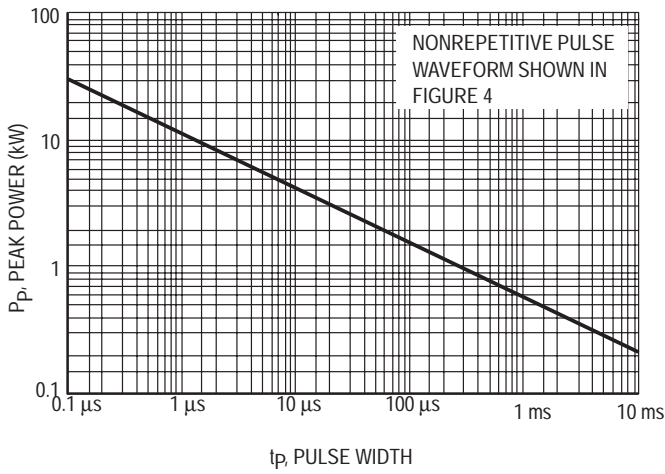


Figure 1. Pulse Rating Curve

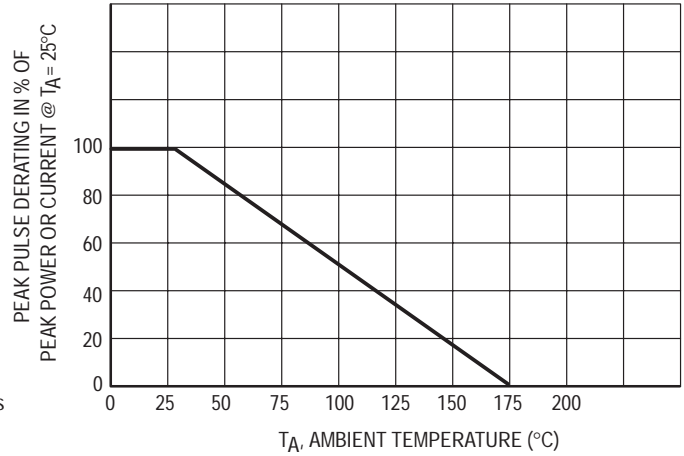


Figure 2. Pulse Derating Curve

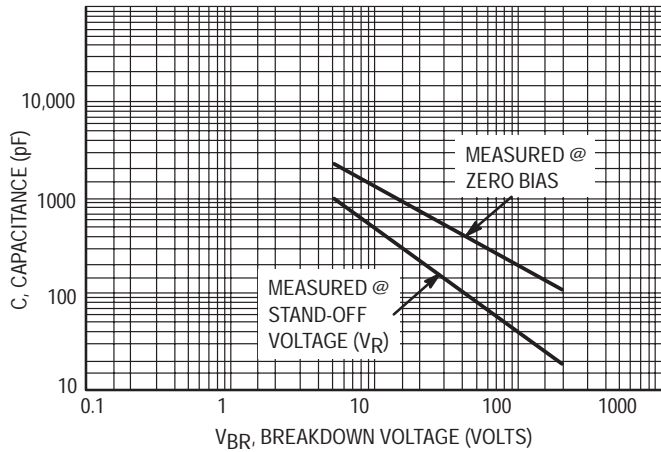


Figure 3. Capacitance versus Breakdown Voltage

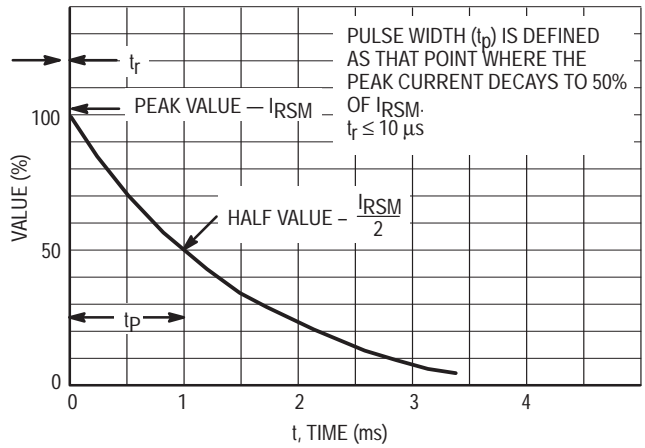


Figure 4. Pulse Waveform

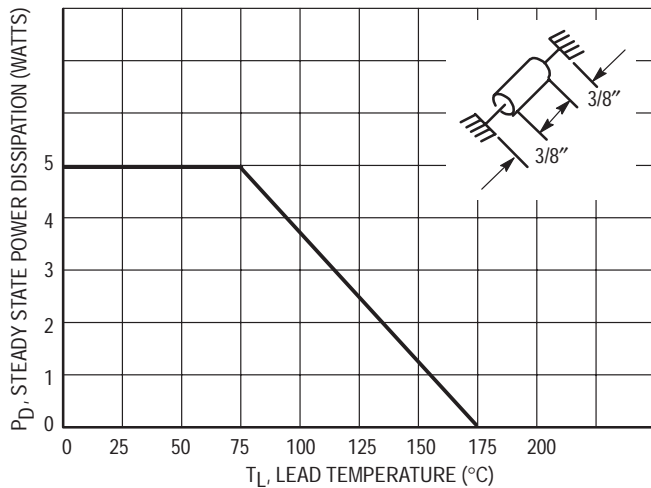


Figure 5. Steady State Power Derating

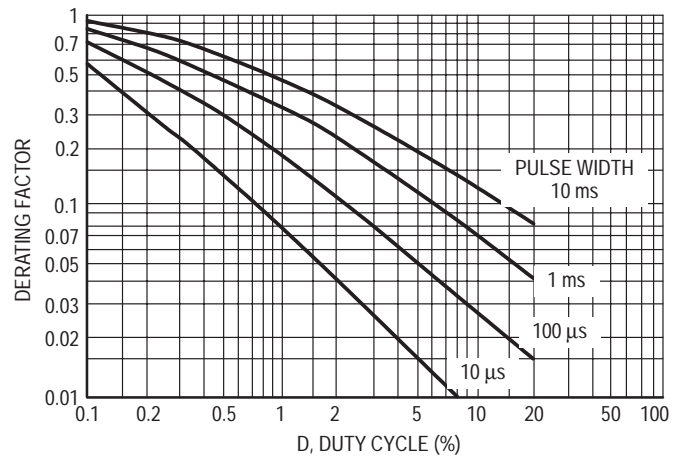


Figure 6. Typical Derating Factor for Duty Cycle

## APPLICATION NOTES

### RESPONSE TIME

In most applications, the transient suppressor device is placed in parallel with the equipment or component to be protected. In this situation, there is a time delay associated with the capacitance of the device and an overshoot condition associated with the inductance of the device and the inductance of the connection method. The capacitance effect is of minor importance in the parallel protection scheme because it only produces a time delay in the transition from the operating voltage to the clamp voltage as shown in Figure A.

The inductive effects in the device are due to actual turn-on time (time required for the device to go from zero current to full current) and lead inductance. This inductive effect produces an overshoot in the voltage across the equipment or component being protected as shown in Figure B. Minimizing this overshoot is very important in the application, since the main purpose for adding a transient suppressor is to clamp voltage spikes. The P6KE6.8A series has very good response time, typically < 1 ns and negligible inductance. However, external inductive effects could produce unacceptable overshoot. Proper circuit layout, minimum lead lengths and placing

the suppressor device as close as possible to the equipment or components to be protected will minimize this overshoot.

Some input impedance represented by  $Z_{in}$  is essential to prevent overstress of the protection device. This impedance should be as high as possible, without restricting the circuit operation.

### DUTY CYCLE DERATING

The data of Figure 1 applies for non-repetitive conditions and at a lead temperature of 25°C. If the duty cycle increases, the peak power must be reduced as indicated by the curves of Figure 6. Average power must be derated as the lead or ambient temperature rises above 25°C. The average power derating curve normally given on data sheets may be normalized and used for this purpose.

At first glance the derating curves of Figure 6 appear to be in error as the 10 ms pulse has a higher derating factor than the 10  $\mu$ s pulse. However, when the derating factor for a given pulse of Figure 6 is multiplied by the peak power value of Figure 1 for the same pulse, the results follow the expected trend.

### TYPICAL PROTECTION CIRCUIT

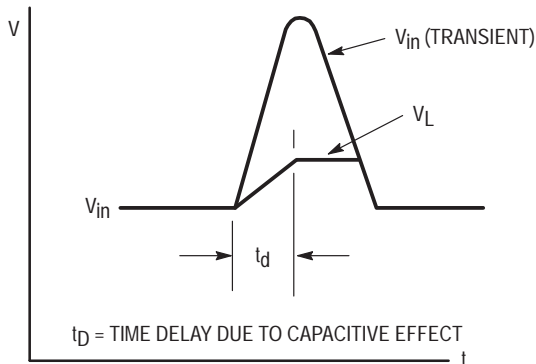
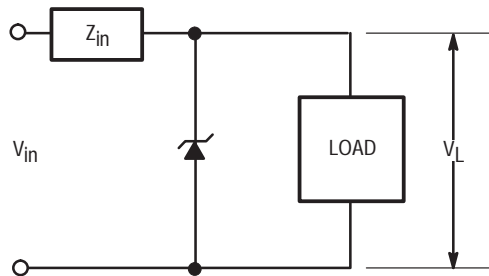


Figure 7.

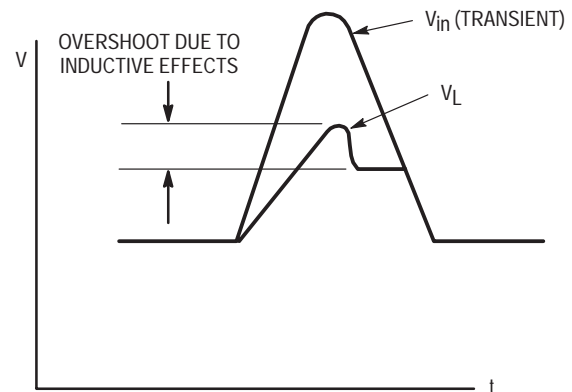


Figure 8.

## UL RECOGNITION

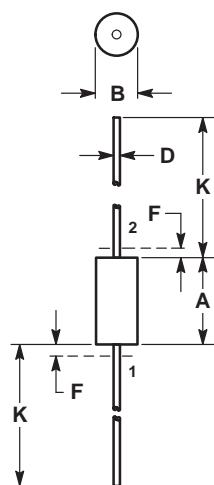
The entire series including the bidirectional CA suffix has *Underwriters Laboratory Recognition* for the classification of protectors (QVGV2) under the UL standard for safety 497B and File #E 116110. Many competitors only have one or two devices recognized or have recognition in a non-protective category. Some competitors have no recognition at all. With the UL497B recognition, our parts successfully passed

several tests including Strike Voltage Breakdown test, Endurance Conditioning, Temperature test, Dielectric Voltage-Withstand test, Discharge test and several more.

Whereas, some competitors have only passed a flammability test for the package material, we have been recognized for much more to be included in their protector category.

# Transient Voltage Suppressors — Axial Leaded

## 600 Watt Peak Power



NOTE:  
1. LEAD DIAMETER & FINISH NOT CONTROLLED  
WITHIN DIM F.

DIM	INCHES		MILLIMETERS	
	MIN	MAX	MIN	MAX
A	0.330	0.350	8.38	8.89
B	0.130	0.145	3.30	3.68
D	0.037	0.043	0.94	1.09
F	—	0.050	—	1.27
K	1.000	1.250	25.40	31.75

STYLE 1:  
PIN 1. ANODE  
2. CATHODE

CASE 17-02  
PLASTIC

(Refer to Section 10 for Surface Mount, Thermal Data and Footprint Information.)

### MULTIPLE PACKAGE QUANTITY (MPQ) REQUIREMENTS

Package Option	Type No. Suffix	MPQ (Units)
Tape and Reel	RL	4K
Tape and Ammo	TA	2K

(Refer to Section 10 for more information on Packaging Specifications.)

Devices listed in bold, italic are Motorola preferred devices.

# 1500 Watt MOSORB

## GENERAL DATA APPLICABLE TO ALL SERIES IN THIS GROUP

### Zener Transient Voltage Suppressors Unidirectional and Bidirectional

Mosorb devices are designed to protect voltage sensitive components from high voltage, high energy transients. They have excellent clamping capability, high surge capability, low zener impedance and fast response time. These devices are Motorola's exclusive, cost-effective, highly reliable Surmetic axial leaded package and are ideally-suited for use in communication systems, numerical controls, process controls, medical equipment, business machines, power supplies and many other industrial/consumer applications, to protect CMOS, MOS and Bipolar integrated circuits.

#### Specification Features:

- Standard Voltage Range — 6.2 to 250 V
- Peak Power — 1500 Watts @ 1 ms
- Maximum Clamp Voltage @ Peak Pulse Current
- Low Leakage < 5  $\mu$ A Above 10 V
- UL Recognition
- Response Time is Typically < 1 ns

#### Mechanical Characteristics:

**CASE:** Void-free, transfer-molded, thermosetting plastic

**FINISH:** All external surfaces are corrosion resistant and leads are readily solderable

**POLARITY:** Cathode indicated by polarity band. When operated in zener mode, will be positive with respect to anode

**MOUNTING POSITION:** Any

**WAFER FAB LOCATION:** Phoenix, Arizona

**ASSEMBLY/TEST LOCATION:** Guadalajara, Mexico

#### MAXIMUM RATINGS

Rating	Symbol	Value	Unit
Peak Power Dissipation (1) @ $T_L \leq 25^\circ\text{C}$	$P_{PK}$	1500	Watts
Steady State Power Dissipation @ $T_L \leq 75^\circ\text{C}$ , Lead Length = 3/8" Derated above $T_L = 75^\circ\text{C}$	$P_D$	5	Watts
		50	mW/ $^\circ\text{C}$
Forward Surge Current (2) @ $T_A = 25^\circ\text{C}$	$I_{FSM}$	200	Amps
Operating and Storage Temperature Range	$T_J, T_{stg}$	- 65 to +175	$^\circ\text{C}$

Lead temperature not less than 1/16" from the case for 10 seconds: 230 $^\circ\text{C}$

NOTES: 1. Nonrepetitive current pulse per Figure 5 and derated above  $T_A = 25^\circ\text{C}$  per Figure 2.

2. 1/2 sine wave (or equivalent square wave), PW = 8.3 ms, duty cycle = 4 pulses per minute maximum.

**GENERAL  
DATA**

**1500 WATT  
PEAK POWER**

**MOSORB  
ZENER OVERVOLTAGE  
TRANSIENT  
SUPPRESSORS**

**6.2-250 VOLTS**

**1500 WATT PEAK POWER**

**5 WATTS STEADY STATE**



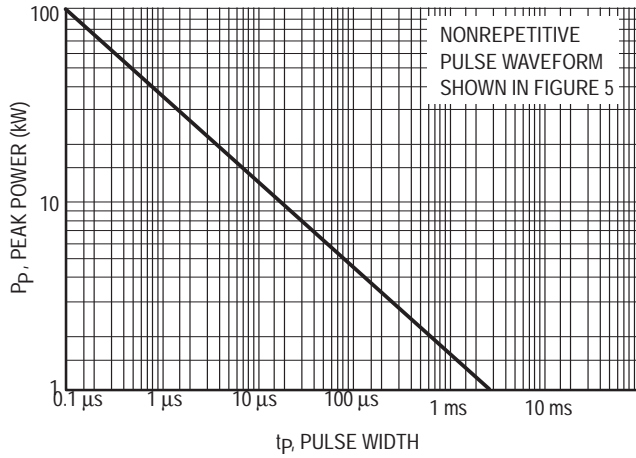


Figure 1. Pulse Rating Curve

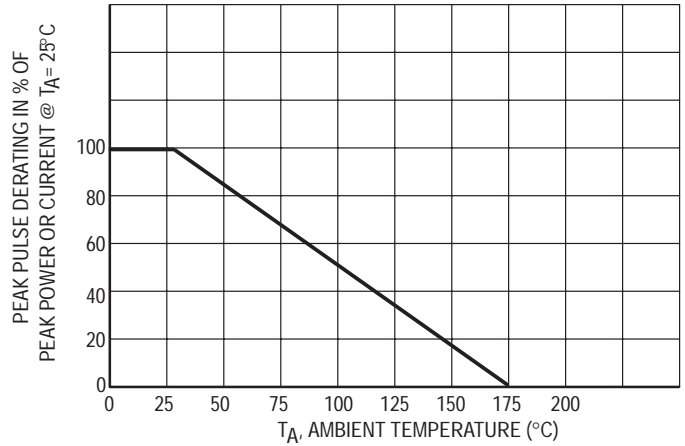
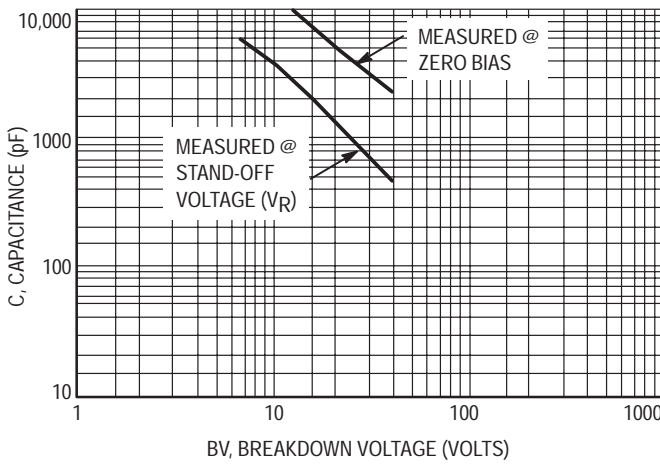


Figure 2. Pulse Derating Curve

**1N6373, ICTE-5, MPTE-5,**  
through  
**1N6389, ICTE-45, C, MPTE-45, C**



**1N6267A/1.5KE6.8A**  
through  
**1N6303A/1.5KE200A**

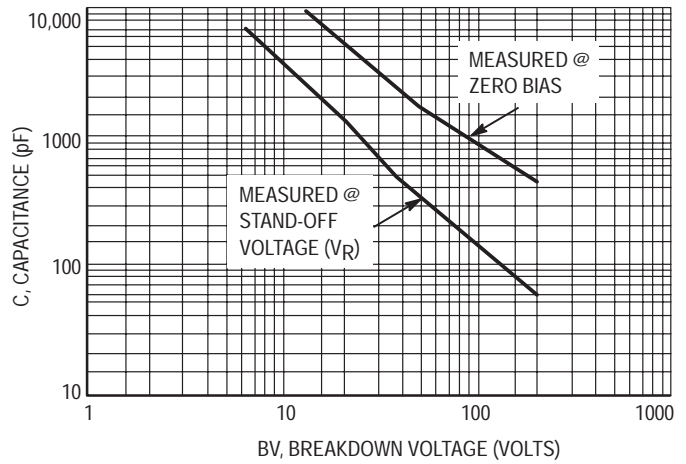


Figure 3. Capacitance versus Breakdown Voltage

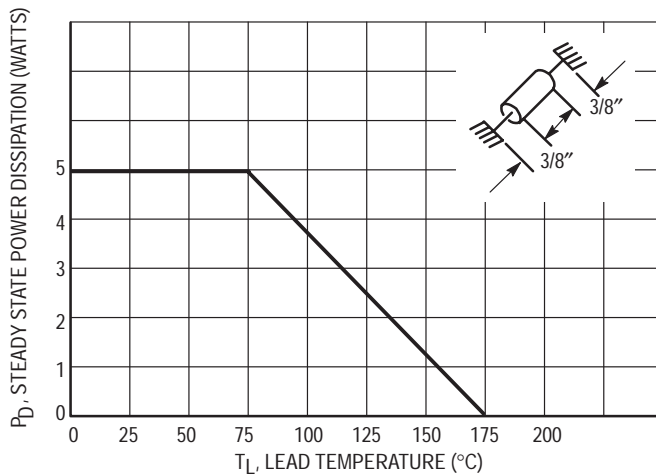


Figure 4. Steady State Power Derating

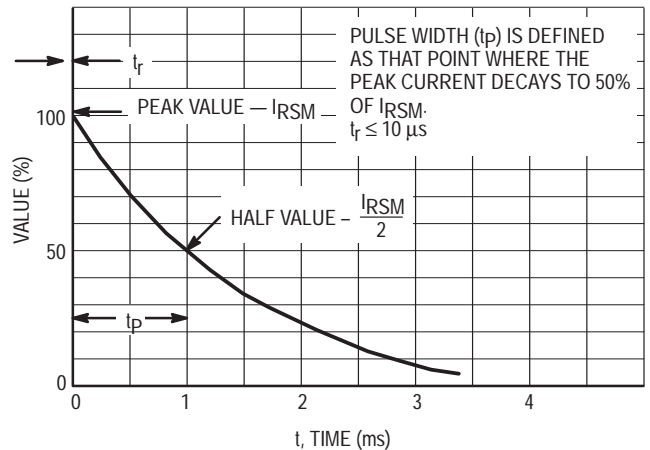
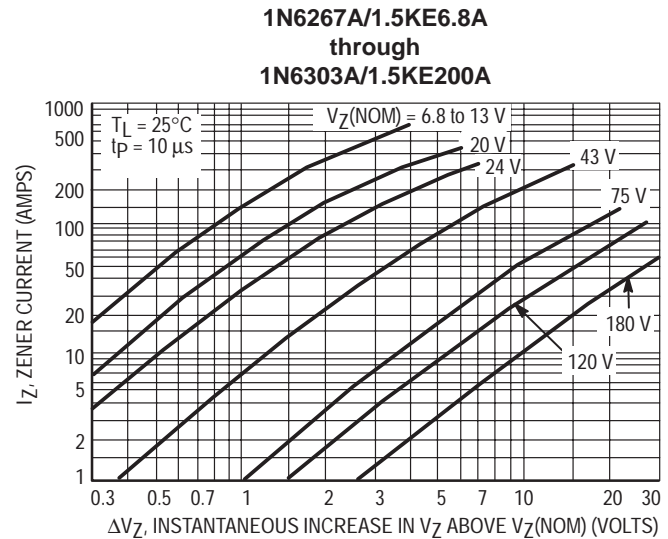
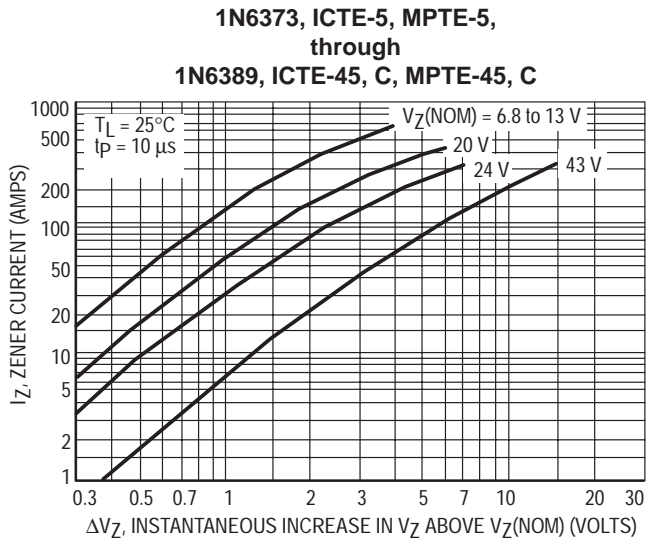
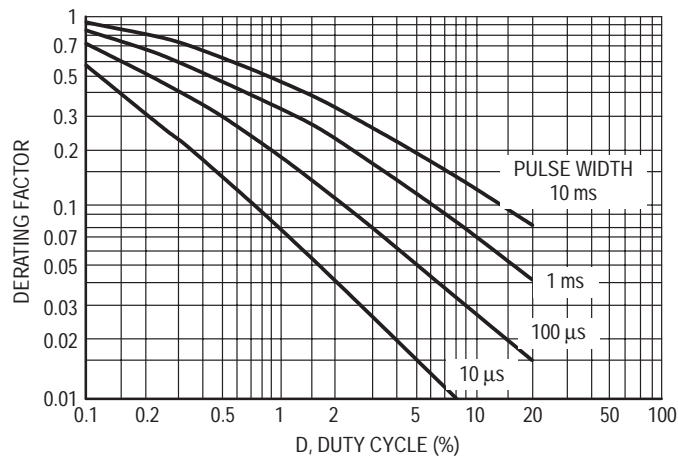


Figure 5. Pulse Waveform

Devices listed in bold, italic are Motorola preferred devices.



**Figure 6. Dynamic Impedance**



**Figure 7. Typical Derating Factor for Duty Cycle**

## APPLICATION NOTES

### RESPONSE TIME

In most applications, the transient suppressor device is placed in parallel with the equipment or component to be protected. In this situation, there is a time delay associated with the capacitance of the device and an overshoot condition associated with the inductance of the device and the inductance of the connection method. The capacitance effect is of minor importance in the parallel protection scheme because it only produces a time delay in the transition from the operating voltage to the clamp voltage as shown in Figure A.

The inductive effects in the device are due to actual turn-on time (time required for the device to go from zero current to full current) and lead inductance. This inductive effect produces an overshoot in the voltage across the equipment or component being protected as shown in Figure B. Minimizing this overshoot is very important in the application, since the main purpose for adding a transient suppressor is to clamp voltage spikes. These devices have excellent response time, typically in the picosecond range and negligible inductance. However, external inductive effects could produce unacceptable overshoot. Proper circuit layout, minimum lead lengths

and placing the suppressor device as close as possible to the equipment or components to be protected will minimize this overshoot.

Some input impedance represented by  $Z_{in}$  is essential to prevent overstress of the protection device. This impedance should be as high as possible, without restricting the circuit operation.

### DUTY CYCLE DERATING

The data of Figure 1 applies for non-repetitive conditions and at a lead temperature of 25°C. If the duty cycle increases, the peak power must be reduced as indicated by the curves of Figure 7. Average power must be derated as the lead or ambient temperature rises above 25°C. The average power derating curve normally given on data sheets may be normalized and used for this purpose.

At first glance the derating curves of Figure 7 appear to be in error as the 10 ms pulse has a higher derating factor than the 10 μs pulse. However, when the derating factor for a given pulse of Figure 7 is multiplied by the peak power value of Figure 1 for the same pulse, the results follow the expected trend.



## TYPICAL PROTECTION CIRCUIT

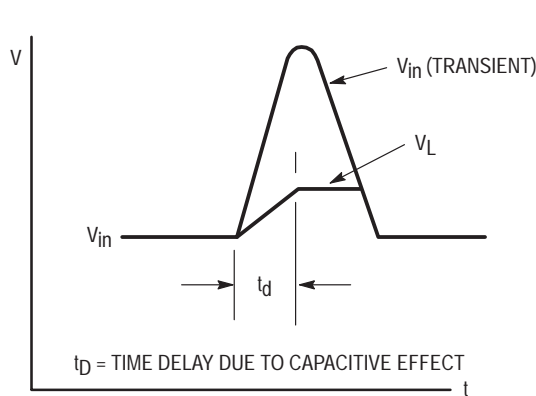
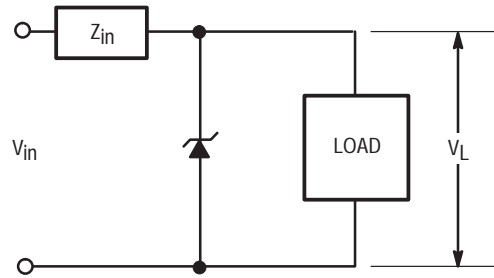


Figure 8.

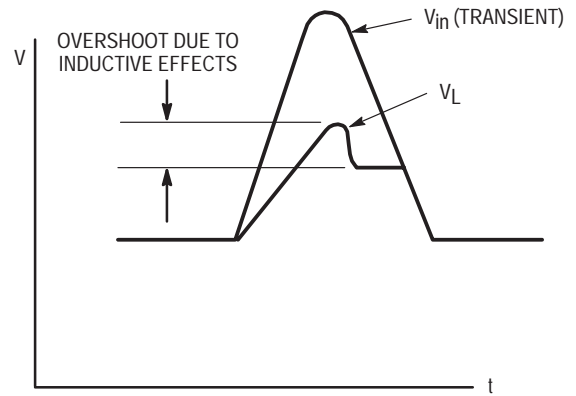


Figure 9.

## UL RECOGNITION\*

The entire series has *Underwriters Laboratory Recognition* for the classification of protectors (QVGV2) under the UL standard for safety 497B and File #116110. Many competitors only have one or two devices recognized or have recognition in a non-protective category. Some competitors have no recognition at all. With the UL497B recognition, our parts successfully passed several tests including Strike Voltage Breakdown test, Endurance Conditioning, Temperature test,

Dielectric Voltage-Withstand test, Discharge test and several more.

Whereas, some competitors have only passed a flammability test for the package material, we have been recognized for much more to be included in their Protector category.

\*Applies to 1.5KE6.8A, CA thru 1.5KE250A, CA

**\*ELECTRICAL CHARACTERISTICS** ( $T_A = 25^\circ\text{C}$  unless otherwise noted)  $V_F = 3.5\text{ V max}$ ,  $I_F^{**} = 100\text{ A}$

Device Note 1	Breakdown Voltage		Maximum Reverse Stand-Off Voltage $V_{RWM}^{***}$ (Volts)	Maximum Reverse Leakage @ $V_{RWM}$ $I_R$ ( $\mu\text{A}$ )	Maximum Reverse Voltage @ $I_{RSM}^\dagger = 120\text{ A}$ (Clamping Voltage) $V_{RSM}$ (Volts)	Clamping Voltage	
	$V_{BR}^{\dagger\dagger}$ (Volts) Min	@ $I_T$ (mA)				Peak Pulse Current @ $I_{PP1}^\dagger = 30\text{ A}$ $V_{C1}$ (Volts max)	Peak Pulse Current @ $I_{PP2}^\dagger = 60\text{ A}$ $V_{C2}$ (Volts max)
<b>1N5908</b>	<b>6</b>	<b>1</b>	<b>5</b>	<b>300</b>	<b>8.5</b>	<b>7.6</b>	<b>8</b>

NOTE 1: The 1N5908 is JEDEC registered as a unidirectional device only (no bidirectional option).

\* Indicates JEDEC registered data.

\*\* 1/2 sine wave (or equivalent square wave),  $PW = 8.3\text{ ms}$ , duty cycle = 4 pulses per minute maximum.

\*\*\* A transient suppressor is normally selected according to the maximum reverse stand-off voltage ( $V_{RWM}$ ), which should be equal to or greater than the dc or continuous peak operating voltage level.

† Surge current waveform per Figure 5 and derate per Figure 2 of the General Data — 1500 W at the beginning of this group.

††  $V_{BR}$  measured at pulse test current  $I_T$  at an ambient temperature of  $25^\circ\text{C}$ .

**\*ELECTRICAL CHARACTERISTICS** ( $T_A = 25^\circ\text{C}$  unless otherwise noted)  $V_F\# = 3.5\text{ V Max}$ ,  $I_F^{**} = 100\text{ A}$

JEDEC Device	Device	Breakdown Voltage				Working Peak Reverse Voltage $V_{RWM}^{***}$ (Volts)	Maximum Reverse Leakage @ $V_{RWM}$ $I_R$ ( $\mu\text{A}$ )	Maximum Reverse Surge Current $I_{RSM}\dagger$ (Amps)	Maximum Reverse Voltage @ $I_{RSM}$ (Clamping Voltage) $V_{RSM}$ (Volts)	Maximum Temperature Coefficient of $V_{BR}$ ( $\%/^\circ\text{C}$ )
		$V_{BR}\ddagger$ Volts			@ $I_T$ (mA)					
		Min	Nom	Max						
<b>1N6267A</b>	1.5KE6.8A	<b>6.45</b>	<b>6.8</b>	<b>7.14</b>	<b>10</b>	<b>5.8</b>	<b>1000</b>	<b>143</b>	<b>10.5</b>	<b>0.057</b>
1N6268A	1.5KE7.5A	7.13	7.5	7.88	10	6.4	500	132	11.3	0.061
1N6269A	1.5KE8.2A	7.79	8.2	8.61	10	7.02	200	124	12.1	0.065
1N6270A	1.5KE9.1A	8.65	9.1	9.55	1	7.78	50	112	13.4	0.068
1N6271A	1.5KE10A	9.5	10	10.5	1	8.55	10	103	14.5	0.073
1N6272A	1.5KE11A	10.5	11	11.6	1	9.4	5	96	15.6	0.075
1N6273A	1.5KE12A	11.4	12	12.6	1	10.2	5	90	16.7	0.078
1N6274A	1.5KE13A	12.4	13	13.7	1	11.1	5	82	18.2	0.081
<b>1N6275A</b>	1.5KE15A	<b>14.3</b>	<b>15</b>	<b>15.8</b>	<b>1</b>	<b>12.8</b>	<b>5</b>	<b>71</b>	<b>21.2</b>	<b>0.084</b>
1N6276A	1.5KE16A	15.2	16	16.8	1	13.6	5	67	22.5	0.086
1N6277A	1.5KE18A	17.1	18	18.9	1	15.3	5	59.5	25.2	0.088
1N6278A	1.5KE20A	19	20	21	1	17.1	5	54	27.7	0.09
1N6279A	<b>1.5KE22A</b>	<b>20.9</b>	<b>22</b>	<b>23.1</b>	<b>1</b>	<b>18.8</b>	<b>5</b>	<b>49</b>	<b>30.6</b>	<b>0.092</b>
<b>1N6280A</b>	1.5KE24A	<b>22.8</b>	<b>24</b>	<b>25.2</b>	<b>1</b>	<b>20.5</b>	<b>5</b>	<b>45</b>	<b>33.2</b>	<b>0.094</b>
<b>1N6281A</b>	1.5KE27A	<b>25.7</b>	<b>27</b>	<b>28.4</b>	<b>1</b>	<b>23.1</b>	<b>5</b>	<b>40</b>	<b>37.5</b>	<b>0.096</b>
<b>1N6282A</b>	1.5KE30A	<b>28.5</b>	<b>30</b>	<b>31.5</b>	<b>1</b>	<b>25.6</b>	<b>5</b>	<b>36</b>	<b>41.4</b>	<b>0.097</b>
<b>1N6283A</b>	1.5KE33A	<b>31.4</b>	<b>33</b>	<b>34.7</b>	<b>1</b>	<b>28.2</b>	<b>5</b>	<b>33</b>	<b>45.7</b>	<b>0.098</b>
1N6284A	1.5KE36A	34.2	36	37.8	1	30.8	5	30	49.9	0.099
<b>1N6285A</b>	<b>1.5KE39A</b>	<b>37.1</b>	<b>39</b>	<b>41</b>	<b>1</b>	<b>33.3</b>	<b>5</b>	<b>28</b>	<b>53.9</b>	<b>0.1</b>
1N6286A	1.5KE43A	40.9	43	45.2	1	36.8	5	25.3	59.3	0.101
1N6287A	1.5KE47A	44.7	47	49.4	1	40.2	5	23.2	64.8	0.101
<b>1N6288A</b>	1.5KE51A	<b>48.5</b>	<b>51</b>	<b>53.6</b>	<b>1</b>	<b>43.6</b>	<b>5</b>	<b>21.4</b>	<b>70.1</b>	<b>0.102</b>
1N6289	<b>1.5KE56A</b>	<b>53.2</b>	<b>56</b>	<b>58.8</b>	<b>1</b>	<b>47.8</b>	<b>5</b>	<b>19.5</b>	<b>77</b>	<b>0.103</b>
1N6290A	1.5KE62A	58.9	62	65.1	1	53	5	17.7	85	0.104
1N6291A	1.5KE68A	64.6	68	71.4	1	58.1	5	16.3	92	0.104
1N6292A	1.5KE75A	71.3	75	78.8	1	64.1	5	14.6	103	0.105
1N6293A	1.5KE82A	77.9	82	86.1	1	70.1	5	13.3	113	0.105
1N6294A	1.5KE91A	86.5	91	95.5	1	77.8	5	12	125	0.106
1N6295A	1.5KE100A	95	100	105	1	85.5	5	11	137	0.106
1N6296A	1.5KE110A	105	110	116	1	94	5	9.9	152	0.107
1N6297A	1.5KE120A	114	120	126	1	102	5	9.1	165	0.107
1N6298A	1.5KE130A	124	130	137	1	111	5	8.4	179	0.107
1N6299A	1.5KE150A	143	150	158	1	128	5	7.2	207	0.108
1N6300A	1.5KE160A	152	160	168	1	136	5	6.8	219	0.108
1N6301A	1.5KE170A	162	170	179	1	145	5	6.4	234	0.108
1N6302A	1.5KE180A	171	180	189	1	154	5	6.1	246	0.108
1N6303A	1.5KE200A	190	200	210	1	171	5	5.5	274	0.108
	1.5KE220A	209	220	231	1	185	5	4.6	328	0.109
	1.5KE250A	237	250	263	1	214	5	5	344	0.109

\* Indicates JEDEC registered data.

\*\* 1/2 sine wave (or equivalent square wave), PW = 8.3 ms, duty cycle = 4 pulses per minute maximum.

\*\*\* A transient suppressor is normally selected according to the maximum reverse stand-off voltage ( $V_{RWM}$ ), which should be equal to or greater than the dc or continuous peak operating voltage level.

† Surge current waveform per Figure 5 and derate per Figure 2 of the General Data — 1500 W at the beginning of this group.

††  $V_{BR}$  measured at pulse test current  $I_T$  at an ambient temperature of  $25^\circ\text{C}$ .

#  $V_F$  applies to Non-CA suffix devices only.

**FOR BIDIRECTIONAL APPLICATIONS**

— **USE CA SUFFIX ON 1.5KE SERIES for 1.5KE6.8CA through 1.5KE250CA.**

**Electrical characteristics apply in both directions.**

**Preferred Bidirectional Devices —**

**1.5KE10CA 1.5KE12CA  
1.5KE18CA 1.5KE36CA**

Devices listed in bold, italic are Motorola preferred devices.

### CLIPPER BIDIRECTIONAL DEVICES

1. Clipper-bidirectional devices are available in the 1.5KEXXA series and are designated with a "CA" suffix; for example, 1.5KE18CA. Contact your nearest Motorola representative.
2. Clipper-bidirectional part numbers are tested in both directions to electrical parameters in preceding table (except for  $V_F$  which does not apply).
3. The 1N6267A through 1N6303A series are JEDEC registered devices and the registration does not include a "CA" suffix. To order clipper-bidirectional devices one must add CA to the 1.5KE device title.

**\*ELECTRICAL CHARACTERISTICS** ( $T_A = 25^\circ\text{C}$  unless otherwise noted)  $V_F\# = 3.5\text{ V Max}$ ,  $I_F^{**} = 100\text{ A}$  (C suffix denotes standard back to back bidirectional versions. Test both polarities)

JEDEC Device Note 1	Device Note 1	Breakdown†† Voltage		Maximum Reverse Stand-Off Voltage $V_{RWM}^{***}$ (Volts)	Maximum Reverse Leakage @ $V_{RWM}$ $I_R$ ( $\mu\text{A}$ )	Maximum Reverse Surge Current $I_{RSM}^\dagger$ (Amps)	Maximum Reverse Voltage @ $I_{RSM}^\dagger$ (Clamping Voltage) $V_{RSM}$ (Volts)	Clamping Voltage	
		$V_{BR}$ Volts Min	@ $I_T$ (mA)					Peak Pulse Current @ $I_{pp1}^\dagger = 1\text{ A}$ $V_{C1}$ (Volts max)	Peak Pulse Current @ $I_{pp1}^\dagger = 10\text{ A}$ $V_{C2}$ (Volts max)
<b>1N6373</b>	<b>ICTE-5/MPTE-5</b>	<b>6</b>	<b>1</b>	<b>5</b>	<b>300</b>	<b>160</b>	<b>9.4</b>	<b>7.1</b>	<b>7.5</b>
1N6374	ICTE-8/MPTE-8	9.4	1	8	25	100	15	11.3	11.5
1N6382	ICTE-8C/MPTE-8C	9.4	1	8	25	100	15	11.4	11.6
1N6375	ICTE-10/MPTE-10	11.7	1	10	2	90	16.7	13.7	14.1
1N6383	ICTE-10C/MPTE-10C	11.7	1	10	2	90	16.7	14.1	14.5
1N6376	ICTE-12/MPTE-12	14.1	1	12	2	70	21.2	16.1	16.5
1N6384	ICTE-12C/MPTE-12C	14.1	1	12	2	70	21.2	16.7	17.1
1N6377	ICTE-15/MPTE-15	17.6	1	15	2	60	25	20.1	20.6
1N6385	ICTE-15C/MPTE-15C	17.6	1	15	2	60	25	20.8	21.4
1N6378	ICTE-18/MPTE-18	21.2	1	18	2	50	30	24.2	25.2
1N6386	ICTE-18C/MPTE-18C	21.2	1	18	2	50	30	24.8	25.5
1N6379	ICTE-22/MPTE-22	25.9	1	22	2	40	37.5	29.8	32
1N6387	ICTE-22C/MPTE-22C	25.9	1	22	2	40	37.5	30.8	32
1N6380	ICTE-36/MPTE-36	42.4	1	36	2	23	65.2	50.6	54.3
1N6388	ICTE-36C/MPTE-36C	42.4	1	36	2	23	65.2	50.6	54.3
1N6381	ICTE-45/MPTE-45	52.9	1	45	2	19	78.9	63.3	70
1N6389	ICTE-45C/MPTE-45C	52.9	1	45	2	19	78.9	63.3	70

NOTE 1: C suffix denotes standard back-to-back bidirectional versions. Test both polarities. JEDEC device types 1N6382 thru 1N6389 are registered as back to back bidirectional versions and do not require a C suffix. 1N6373 thru 1N6381 are registered as unidirectional devices only (no bidirectional option).

\* Indicates JEDEC registered data.

\*\* 1/2 sine wave (or equivalent square wave),  $PW = 8.3\text{ ms}$ , duty cycle = 4 pulses per minute maximum.

\*\*\* A transient suppressor is normally selected according to the maximum reverse stand-off voltage ( $V_{RWM}$ ), which should be equal to or greater than the dc or continuous peak operating voltage level.

† Surge current waveform per Figure 5 and derate per Figure 2 of the General Data — 1500 W at the beginning of this group.

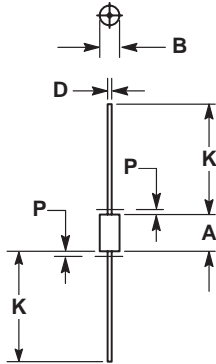
††  $V_{BR}$  measured at pulse test current  $I_T$  at an ambient temperature of  $25^\circ\text{C}$ .

#  $V_F$  applies to unidirectional devices only.

Devices listed in bold, italic are Motorola preferred devices.

# Transient Voltage Suppressors — Axial Leaded

## 1500 Watt Peak Power



- NOTES:
1. DIMENSIONING AND TOLERANCING PER ANSI Y14.5M, 1982.
  2. CONTROLLING DIMENSION: INCH.
  3. LEAD FINISH AND DIAMETER UNCONTROLLED IN DIM P.

DIM	INCHES		MILLIMETERS	
	MIN	MAX	MIN	MAX
A	0.360	0.375	9.14	9.52
B	0.190	0.205	4.83	5.21
D	0.038	0.042	0.97	1.07
K	1.000	—	25.40	—
P	—	0.050	—	1.27

**CASE 41A-02  
PLASTIC**

(Refer to Section 10 for Surface Mount, Thermal Data and Footprint Information.)

### MULTIPLE PACKAGE QUANTITY (MPQ) REQUIREMENTS

Package Option	Type No. Suffix	MPQ (Units)
Tape and Reel	RL4	1.5K

(Refer to Section 10 for more information on Packaging Specifications.)

# Overvoltage Transient Suppressors

Overvoltage transient suppressors are designed for applications requiring a low voltage rectifier with reverse avalanche characteristics for use as reverse power transient suppressors. Developed to suppress transients in the automotive system, these devices operate in the forward mode as standard rectifiers or reverse mode as power avalanche rectifier and will protect electronic equipment from overvoltage conditions.

- Avalanche Voltage 24 to 32 Volts
- High Power Capability
- Economical
- Increased Capacity by Parallel Operation

## MECHANICAL CHARACTERISTICS:

**CASE:** Transfer Molded Plastic

**MAXIMUM LEAD TEMPERATURE FOR SOLDERING PURPOSES:** 350°C 3/8" from case for 10 seconds at 5 lbs. tension

**FINISH:** All external surfaces are corrosion-resistant, leads are readily solderable

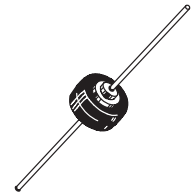
**POLARITY:** Indicated by diode symbol or cathode band

**WEIGHT:** 2.5 Grams (approx.)

# MR2535L

Motorola Preferred Device

**MEDIUM CURRENT  
OVERVOLTAGE  
TRANSIENT  
SUPPRESSORS**



CASE 194-04, Style 1

## MAXIMUM RATINGS

Rating	Symbol	Value	Unit
DC Peak Repetitive Reverse Voltage Working Peak Reverse Voltage DC Blocking Voltage	$V_{RRM}$ $V_{RWM}$ $V_R$	20	Volts
Repetitive Peak Reverse Surge Current (Time Constant = 10 ms, Duty Cycle $\leq$ 1%, $T_C = 25^\circ\text{C}$ ) (See Figure 1)	$I_{RSM}$	110	Amps
Average Rectified Forward Current (Single Phase, Resistive Load, 60 Hz, $T_C = 150^\circ\text{C}$ )	$I_O$	35	Amps
Non-Repetitive Peak Surge Current Surge Supplied at Rated Load Conditions Halfwave, Single Phase	$I_{FSM}$	600	Amps
Operating and Storage Junction Temperature Range	$T_J, T_{stg}$	-65 to +175	$^\circ\text{C}$

## THERMAL CHARACTERISTICS

Characteristic	Lead Length	Symbol	Max	Unit
Thermal Resistance, Junction to Lead @ Both Leads to Heat Sink, Equal Length	1/4"	$R_{\theta JL}$	7.5	$^\circ\text{C/W}$
	3/8"		10	
	1/2"		13	
Thermal Resistance Junction to Case		$R_{\theta JC}$	0.8*	$^\circ\text{C/W}$

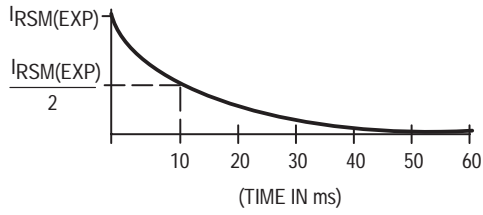
\*Typical

Devices listed in bold, italic are Motorola preferred devices.

**ELECTRICAL CHARACTERISTICS**

Characteristic	Symbol	Min	Max	Unit
Instantaneous Forward Voltage (1) ( $i_F = 100$ Amps, $T_C = 25^\circ\text{C}$ )	$V_F$	—	1.1	Volts
Reverse Current ( $V_R = 20$ Vdc, $T_C = 25^\circ\text{C}$ )	$I_R$	—	200	nA dc
Breakdown Voltage (1) ( $I_R = 100$ mA dc, $T_C = 25^\circ\text{C}$ )	$V_{(BR)}$	24	32	Volts
Breakdown Voltage (1) ( $I_R = 90$ Amp, $T_C = 150^\circ\text{C}$ , $PW = 80 \mu\text{s}$ )	$V_{(BR)}$	—	40	Volts
Breakdown Voltage Temperature Coefficient	$V_{(BR)TC}$	—	0.096*	%/ $^\circ\text{C}$
Forward Voltage Temperature Coefficient @ $I_F = 10$ mA	$V_{FTC}$	—	2*	mV/ $^\circ\text{C}$

(1) Pulse Test: Pulse Width  $\leq 300 \mu\text{s}$ , Duty Cycle  $\leq 2\%$ .  
\*Typical

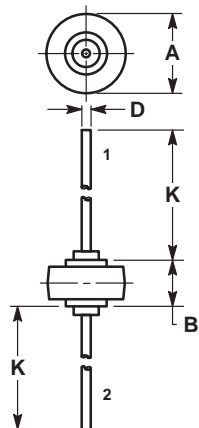


**Figure 1. Surge Current Characteristics**



# Transient Voltage Suppressors — Axial Leaded

## Overvoltage 110 Amp Repetitive Peak



NOTE:  
1. CATHODE SYMBOL ON PACKAGE.

DIM	MILLIMETERS		INCHES	
	MIN	MAX	MIN	MAX
A	8.43	8.69	0.332	0.342
B	5.94	6.25	0.234	0.246
D	1.27	1.35	0.050	0.053
K	25.15	25.65	0.990	1.010

STYLE 1:  
PIN 1. CATHODE  
2. ANODE

**CASE 194-04**  
**PLASTIC**

(Refer to Section 10 for Surface Mount, Thermal Data and Footprint Information.)

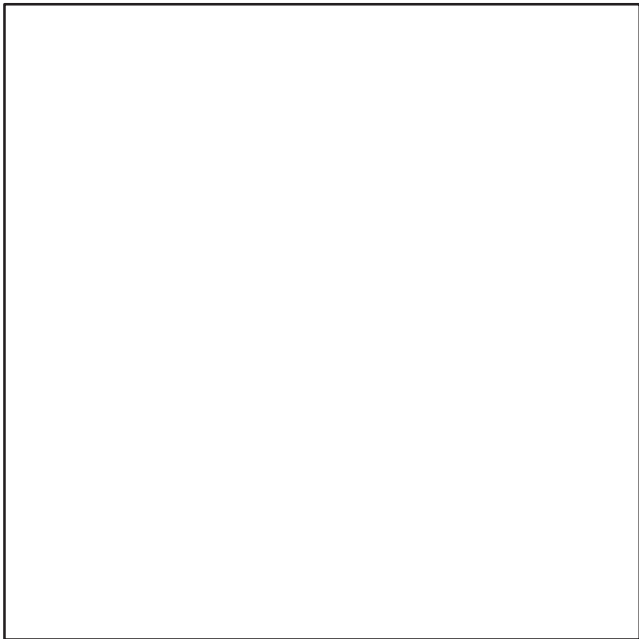
### MULTIPLE PACKAGE QUANTITY (MPQ) REQUIREMENTS

Package Option	Type No. Suffix	MPQ (Units)
Tape and Reel	RL	800

(Refer to Section 10 for more information on Packaging Specifications.)

Devices listed in bold, italic are Motorola preferred devices.





# Section Five

## Transient Voltage Suppressors — Surface Mounted Data Sheets

<b>24 Watt Peak Power</b>	
MMBZ5V6ALT1 .....	5-2
<b>40 Watt Peak Power</b>	
MMBZ15VDLT1 .....	NO TAG
<b>600 Watt Peak Power</b>	
General Data — 600 Watt .....	NO TAG
1SMB5.0AT3 through 1SMB170AT3 .....	NO TAG
1SMB10CAT3 through 1SMB78AT3 .....	NO TAG
P6SMB6.8AT3 through P6SMB200AT3 .....	NO TAG
P6SMB11CAT3 through P6SMB91CAT3 .....	NO TAG
<b>1500 Watt Peak Power</b>	
General Data — 1500 Watt .....	NO TAG
1SMC5.0AT3 through 1SMC78AT3 .....	NO TAG
1.5SMC6.8AT3 through 1.5SMC91AT3 .....	NO TAG
NO TAG	

# SOT-23 Dual Monolithic Common Anode Zener Transient Voltage Suppressor For ESD Protection

This dual monolithic silicon zener diode is designed for applications requiring transient overvoltage protection capability. It is intended for use in voltage and ESD sensitive equipment such as computers, printers, business machines, communication systems, medical equipment and other applications. Its dual junction common anode design protects two separate lines using only one package. These devices are ideal for situations where board space is at a premium.

**Specification Features:**

- SOT-23 Package Allows Either Two Separate Unidirectional Configurations or a Single Bidirectional Configuration
- Peak Power — 24 Watts @ 1.0 ms (Unidirectional), per Figure 5 Waveform
- Maximum Clamping Voltage @ Peak Pulse Current
- Low Leakage < 5.0  $\mu$ A
- ESD Rating of Class N (exceeding 16 kV) per the Human Body Model

**Mechanical Characteristics:**

- Void Free, Transfer-Molded, Thermosetting Plastic Case
- Corrosion Resistant Finish, Easily Solderable
- Package Designed for Optimal Automated Board Assembly
- Small Package Size for High Density Applications
- Available in 8 mm Tape and Reel  
Use the Device Number to Order the 7 inch/3,000 Unit Reel  
Replace "T1" with "T3" in the Device Number to Order the 13 inch/10,000 Unit Reel

**WAFER FAB LOCATION:** Phoenix, Arizona  
**ASSEMBLY/TEST LOCATION:** Seremban, Malaysia

**THERMAL CHARACTERISTICS** ( $T_A = 25^\circ\text{C}$  unless otherwise noted)

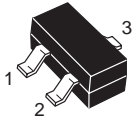
Characteristic	Symbol	Value	Unit
Peak Power Dissipation @ 1.0 ms (1) @ $T_A \leq 25^\circ\text{C}$	$P_{pk}$	24	Watts
Total Power Dissipation on FR-5 Board (2) @ $T_A = 25^\circ\text{C}$ Derate above $25^\circ\text{C}$	$P_D$	225 1.8	mW mW/ $^\circ\text{C}$
Thermal Resistance Junction to Ambient	$R_{\theta JA}$	556	$^\circ\text{C}/\text{W}$
Total Power Dissipation on Alumina Substrate (3) @ $T_A = 25^\circ\text{C}$ Derate above $25^\circ\text{C}$	$P_D$	300 2.4	mW mW/ $^\circ\text{C}$
Thermal Resistance Junction to Ambient	$R_{\theta JA}$	417	$^\circ\text{C}/\text{W}$
Junction and Storage Temperature Range	$T_J$ $T_{stg}$	- 55 to +150	$^\circ\text{C}$
Lead Solder Temperature — Maximum (10 Second Duration)	$T_L$	260	$^\circ\text{C}$

(1) Non-repetitive current pulse per Figure 5 and derate above  $T_A = 25^\circ\text{C}$  per Figure 6.  
(2) FR-5 = 1.0 x 0.75 x 0.62 in.  
(3) Alumina = 0.4 x 0.3 x 0.024 in., 99.5% alumina


Thermal Clad is a trademark of the Bergquist Company.

**MMBZ5V6ALT1**  
ADDITIONAL VOLTAGES AVAILABLE  
Motorola Preferred Device

**SOT-23 DUAL  
ZENER OVERVOLTAGE  
TRANSIENT SUPPRESSOR  
5.6 VOLTS  
24 WATTS PEAK POWER**



**CASE 318-07  
STYLE 12  
LOW PROFILE SOT-23  
PLASTIC**



PIN 1. CATHODE  
2. CATHODE  
3. ANODE

Preferred devices are Motorola recommended choices for future use and best overall value.

# MMBZ5V6ALT1

**ELECTRICAL CHARACTERISTICS** ( $T_A = 25^\circ\text{C}$  unless otherwise noted)  
**UNIDIRECTIONAL** (Circuit tied to pins 1 and 3 or Pins 2 and 3) ( $V_F = 0.9\text{ V Max @ } I_F = 10\text{ mA}$ )

Breakdown Voltage			Max Reverse Leakage Current $I_R @ V_R$ ( $\mu\text{A}$ ) (V)	Max Zener Impedance (6)		Max Reverse Surge Current $I_{RSM(5)}$ (A)	Max Reverse Voltage @ $I_{RSM(5)}$ (Clamping Voltage) $V_{RSM}$ (V)	Maximum Temperature Coefficient of $V_Z$ ( $\text{mV}/^\circ\text{C}$ )			
$V_{ZT(4)}$ (V)				$Z_{ZT}$ @ $I_{ZT}$ ( $\Omega$ ) (mA)	$Z_{ZK}$ @ $I_{ZK}$ ( $\Omega$ ) (mA)						
Min	Nom	Max	@ $I_{ZT}$ (mA)								
5.32	5.6 <sup>(7)</sup>	5.88	20	5.0	3.0	11	1600	0.25	3.0	8.0	1.26

(4)  $V_Z$  measured at pulse test current  $I_T$  at an ambient temperature of  $25^\circ\text{C}$ .

(5) Surge current waveform per Figure 5 and derate per Figure 6.

(6)  $Z_{ZT}$  and  $Z_{ZK}$  are measured by dividing the AC voltage drop across the device by the AC current supplied. The specified limits are  $I_{Z(AC)} = 0.1 I_{Z(DC)}$ , with AC frequency = 1 kHz.

(7) Other voltages may be available upon request. Please contact your Motorola representative.

## TYPICAL CHARACTERISTICS

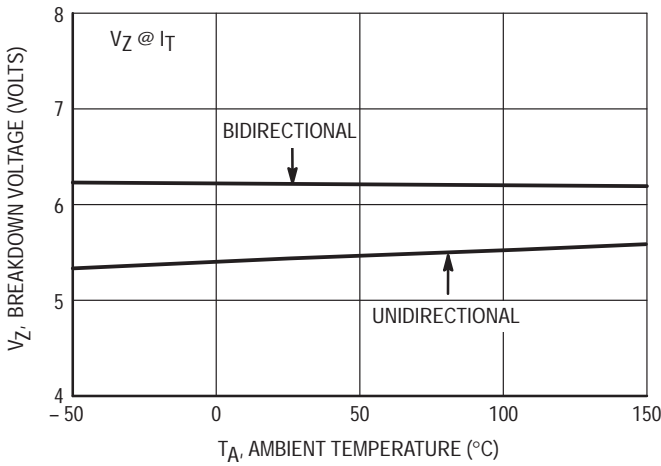


Figure 1. Typical Breakdown Voltage versus Temperature

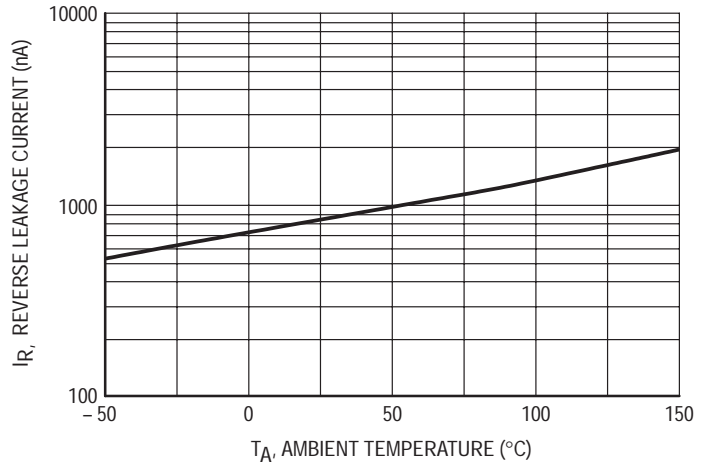


Figure 2. Typical Leakage Current versus Temperature

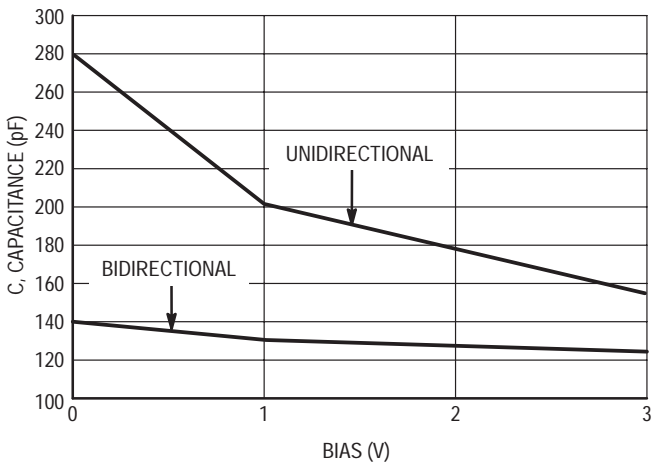


Figure 3. Typical Capacitance versus Bias Voltage

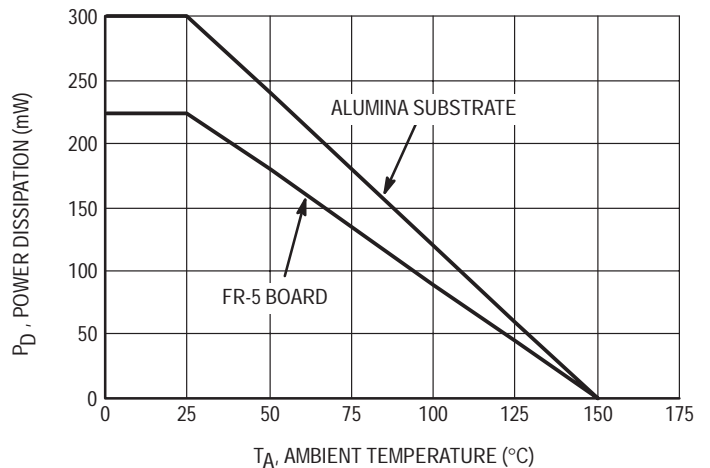


Figure 4. Steady State Power Derating Curve

# MMBZ5V6ALT1

## TYPICAL CHARACTERISTICS

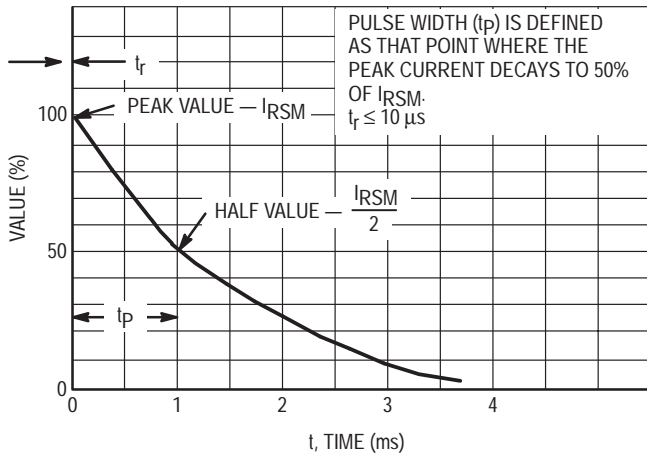


Figure 5. Pulse Waveform

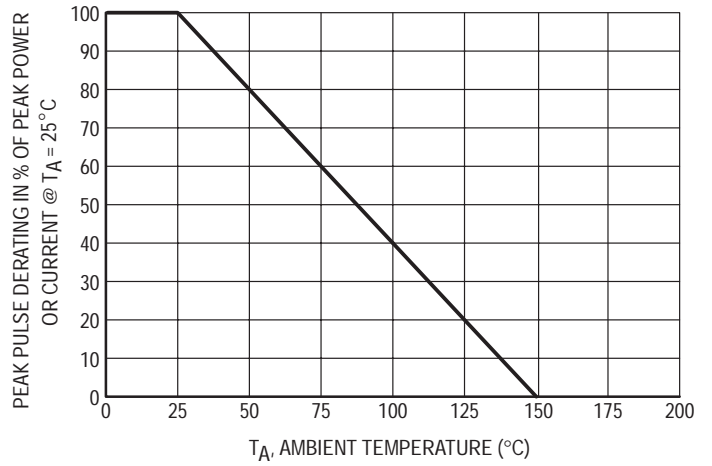


Figure 6. Pulse Derating Curve

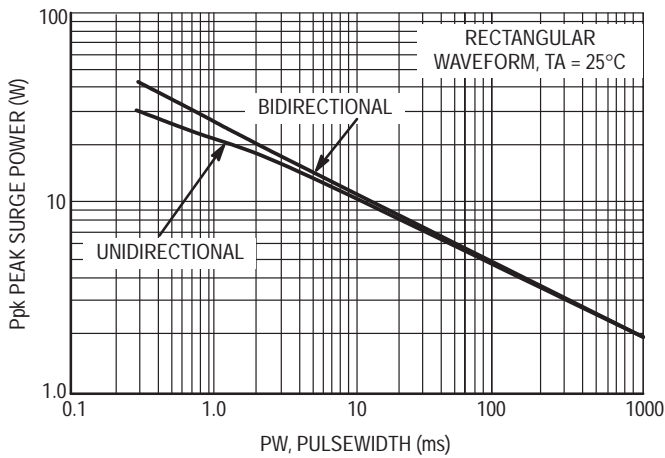


Figure 7. Maximum Non-repetitive Surge Power,  $P_{pk}$  versus PW

Power is defined as  $V_{RSM} \times I_Z(pk)$  where  $V_{RSM}$  is the clamping voltage at  $I_Z(pk)$ .

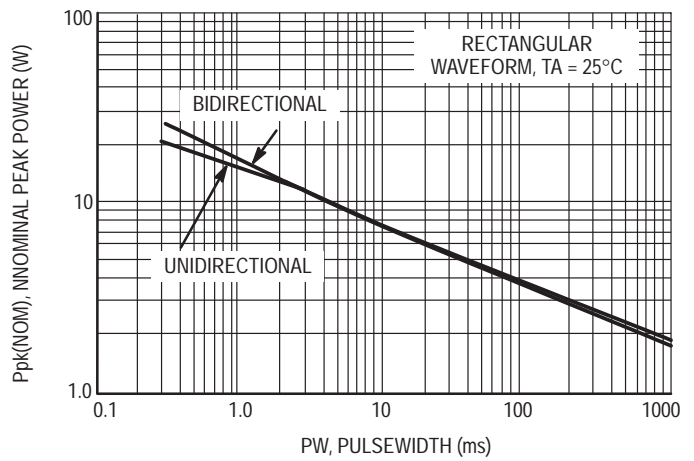


Figure 8. Maximum Non-repetitive Surge Power,  $P_{pk}(NOM)$  versus PW

Power is defined as  $V_Z(NOM) \times I_Z(pk)$  where  $V_Z(NOM)$  is the nominal zener voltage measured at the low test current used for voltage classification.

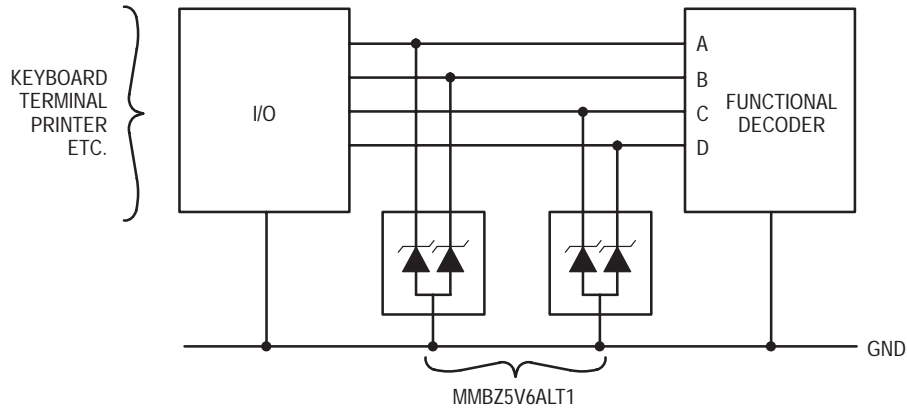
# MMBZ5V6ALT1

## TYPICAL COMMON ANODE APPLICATIONS

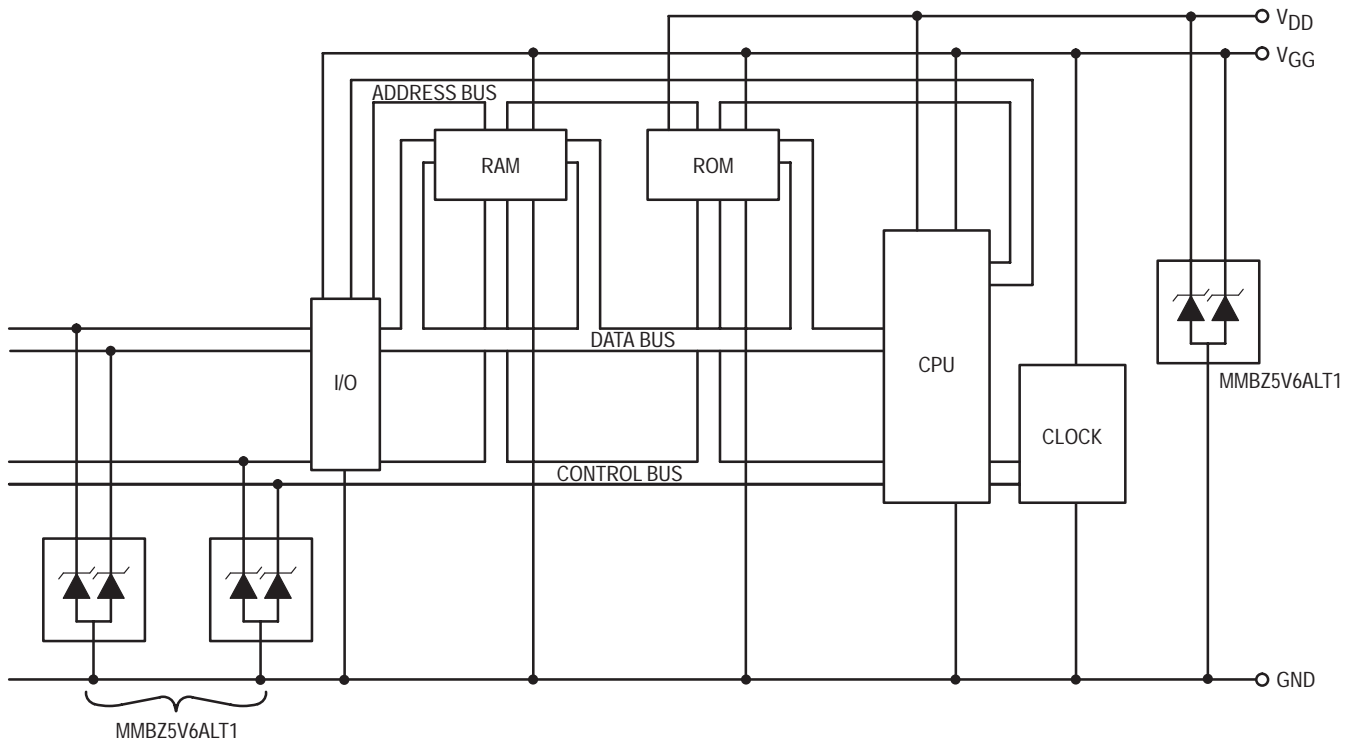
A dual junction common anode design in a SOT-23 package protects two separate lines using only one package. This adds flexibility and creativity to PCB design especially when

board space is at a premium. Two simplified examples of MMBZ5V6ALT1 TVS applications are illustrated below.

### Computer Interface Protection



### Microprocessor Protection



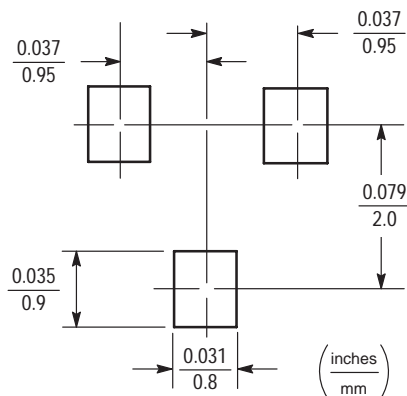
# MMBZ5V6ALT1

## INFORMATION FOR USING THE SOT-23 SURFACE MOUNT PACKAGE

### MINIMUM RECOMMENDED FOOTPRINT FOR SURFACE MOUNTED APPLICATIONS

Surface mount board layout is a critical portion of the total design. The footprint for the semiconductor packages must be the correct size to insure proper solder connection interface

between the board and the package. With the correct pad geometry, the packages will self align when subjected to a solder reflow process.



SOT-23

### SOT-23 POWER DISSIPATION

The power dissipation of the SOT-23 is a function of the drain pad size. This can vary from the minimum pad size for soldering to a pad size given for maximum power dissipation. Power dissipation for a surface mount device is determined by  $T_{J(max)}$ , the maximum rated junction temperature of the die,  $R_{\theta JA}$ , the thermal resistance from the device junction to ambient, and the operating temperature,  $T_A$ . Using the values provided on the data sheet for the SOT-23 package,  $P_D$  can be calculated as follows:

$$P_D = \frac{T_{J(max)} - T_A}{R_{\theta JA}}$$

The values for the equation are found in the maximum ratings table on the data sheet. Substituting these values into the equation for an ambient temperature  $T_A$  of 25°C, one can calculate the power dissipation of the device which in this case is 225 milliwatts.

$$P_D = \frac{150^\circ\text{C} - 25^\circ\text{C}}{556^\circ\text{C/W}} = 225 \text{ milliwatts}$$

The 556°C/W for the SOT-23 package assumes the use of the recommended footprint on a glass epoxy printed circuit board to achieve a power dissipation of 225 milliwatts. There are other alternatives to achieving higher power dissipation from the SOT-23 package. Another alternative would be to use a ceramic substrate or an aluminum core board such as Thermal Clad™. Using a board material such as Thermal Clad, an aluminum core board, the power dissipation can be doubled using the same footprint.

### SOLDERING PRECAUTIONS

The melting temperature of solder is higher than the rated temperature of the device. When the entire device is heated to a high temperature, failure to complete soldering within a short time could result in device failure. Therefore, the following items should always be observed in order to minimize the thermal stress to which the devices are subjected.

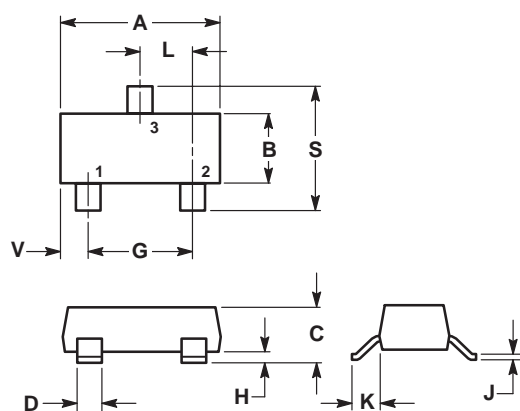
- Always preheat the device.
- The delta temperature between the preheat and soldering should be 100°C or less.\*
- When preheating and soldering, the temperature of the leads and the case must not exceed the maximum temperature ratings as shown on the data sheet. When using infrared heating with the reflow soldering method, the difference shall be a maximum of 10°C.
- The soldering temperature and time shall not exceed 260°C for more than 10 seconds.
- When shifting from preheating to soldering, the maximum temperature gradient shall be 5°C or less.
- After soldering has been completed, the device should be allowed to cool naturally for at least three minutes. Gradual cooling should be used as the use of forced cooling will increase the temperature gradient and result in latent failure due to mechanical stress.
- Mechanical stress or shock should not be applied during cooling.

\* Soldering a device without preheating can cause excessive thermal shock and stress which can result in damage to the device.



# Transient Voltage Suppressors — Surface Mounted

## 24 Watt Peak Power



**NOTES:**

1. DIMENSIONING AND TOLERANCING PER ANSI Y14.5M, 1982.
2. CONTROLLING DIMENSION: INCH.
3. MAXIMUM LEAD THICKNESS INCLUDES LEAD FINISH THICKNESS. MINIMUM LEAD THICKNESS IS THE MINIMUM THICKNESS OF BASE MATERIAL.

DIM	INCHES		MILLIMETERS	
	MIN	MAX	MIN	MAX
A	0.1102	0.1197	2.80	3.04
B	0.0472	0.0551	1.20	1.40
C	0.0350	0.0440	0.89	1.11
D	0.0150	0.0200	0.37	0.50
G	0.0701	0.0807	1.78	2.04
H	0.0005	0.0040	0.013	0.100
J	0.0034	0.0070	0.085	0.177
K	0.0180	0.0236	0.45	0.60
L	0.0350	0.0401	0.89	1.02
S	0.0830	0.0984	2.10	2.50
V	0.0177	0.0236	0.45	0.60

**STYLE 12:**

- PIN 1. CATHODE
2. CATHODE
3. ANODE

**CASE 318-07  
PLASTIC**

(Refer to Section 10 for Surface Mount, Thermal Data and Footprint Information.)

### MULTIPLE PACKAGE QUANTITY (MPQ) REQUIREMENTS

Package Option	Type No. Suffix	MPQ (Units)
Tape and Reel	T1	3K
Tape and Reel	T3	10K

(Refer to Section 10 for more information on Packaging Specifications.)

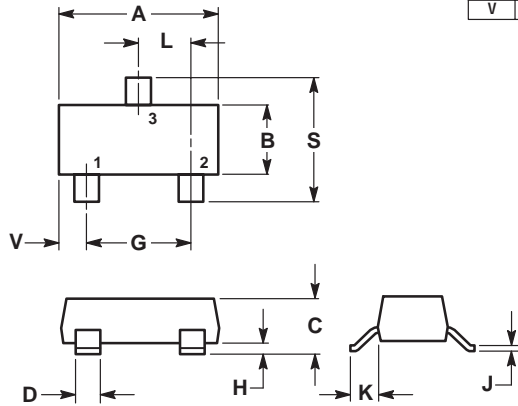
# Transient Voltage Suppressors — Surface Mounted

## 40 Watt Peak Power

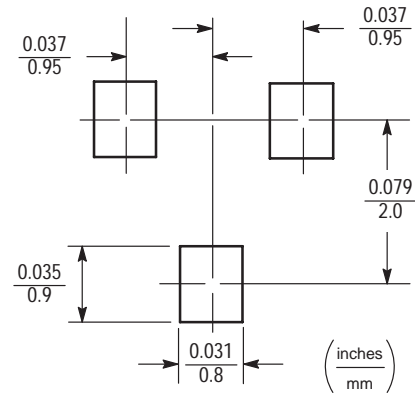
**NOTES:**

1. DIMENSIONING AND TOLERANCING PER ANSI Y14.5M, 1982.
2. CONTROLLING DIMENSION: INCH.
3. MAXIMUM LEAD THICKNESS INCLUDES LEAD FINISH THICKNESS. MINIMUM LEAD THICKNESS IS THE MINIMUM THICKNESS OF BASE MATERIAL.

DIM	INCHES		MILLIMETERS	
	MIN	MAX	MIN	MAX
A	0.1102	0.1197	2.80	3.04
B	0.0472	0.0551	1.20	1.40
C	0.0350	0.0440	0.89	1.11
D	0.0150	0.0200	0.37	0.50
G	0.0701	0.0807	1.78	2.04
H	0.0005	0.0040	0.013	0.100
J	0.0034	0.0070	0.085	0.177
K	0.0180	0.0236	0.45	0.60
L	0.0350	0.0401	0.89	1.02
S	0.0830	0.0984	2.10	2.50
V	0.0177	0.0236	0.45	0.60



STYLE 9:  
PIN 1. ANODE  
2. ANODE  
3. CATHODE



**SOT-23 Footprint**

**CASE 318-07  
PLASTIC**

(Refer to Section 10 for Surface Mount, Thermal Data and Footprint Information.)

### MULTIPLE PACKAGE QUANTITY (MPQ) REQUIREMENTS

Package Option	Type No. Suffix	MPQ (Units)
Tape and Reel	T1	3K
Tape and Reel	T3	10K

(Refer to Section 10 for more information on Packaging Specifications.)

**GENERAL DATA APPLICABLE TO ALL SERIES IN THIS GROUP**

**Zener Transient Voltage Suppressors**

The SMB series is designed to protect voltage sensitive components from high voltage, high energy transients. They have excellent clamping capability, high surge capability, low zener impedance and fast response time. The SMB series is supplied in Motorola's exclusive, cost-effective, highly reliable Surmetic package and is ideally suited for use in communication systems, numerical controls, process controls, medical equipment, business machines, power supplies and many other industrial/consumer applications.

**Specification Features:**

- Standard Zener Breakdown Voltage Range — 6.8 to 200 V
- Stand-off Voltage Range — 5 to 170 V
- Peak Power — 600 Watts @ 1 ms
- Maximum Clamp Voltage @ Peak Pulse Current
- Low Leakage < 5  $\mu$ A Above 10 V
- UL Recognition
- Response Time Typically < 1 ns

**Mechanical Characteristics:**

**CASE:** Void-free, transfer-molded, thermosetting plastic

**FINISH:** All external surfaces are corrosion resistant and leads are readily solderable

**POLARITY:** Cathode indicated by molded polarity notch. When operated in zener mode, will be positive with respect to anode

**MOUNTING POSITION:** Any

**LEADS:** Modified L-Bend providing more contact area to bond pad

**MAXIMUM CASE TEMPERATURE FOR SOLDERING PURPOSES:** 260°C for 10 seconds

**WAFER FAB LOCATION:** Phoenix, Arizona

**ASSEMBLY/TEST LOCATION:** Seremban, Malaysia

**GENERAL  
DATA  
600 WATT  
PEAK POWER**

**PLASTIC SURFACE MOUNT  
ZENER OVERVOLTAGE  
TRANSIENT  
SUPPRESSORS  
6.8–200 VOLTS  
600 WATT PEAK POWER**



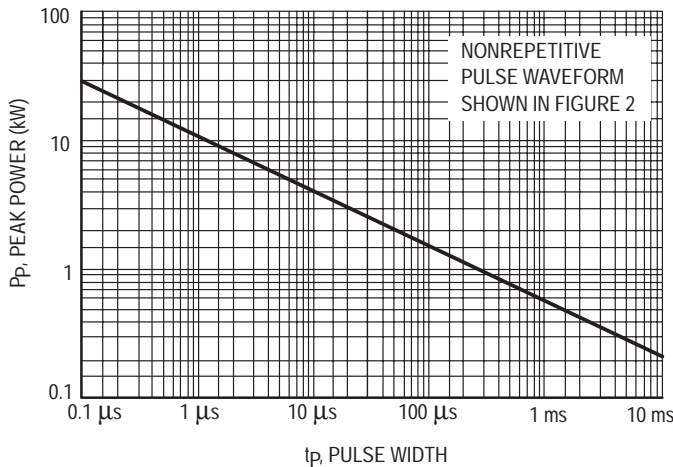
**CASE 403A  
PLASTIC**

**MAXIMUM RATINGS**

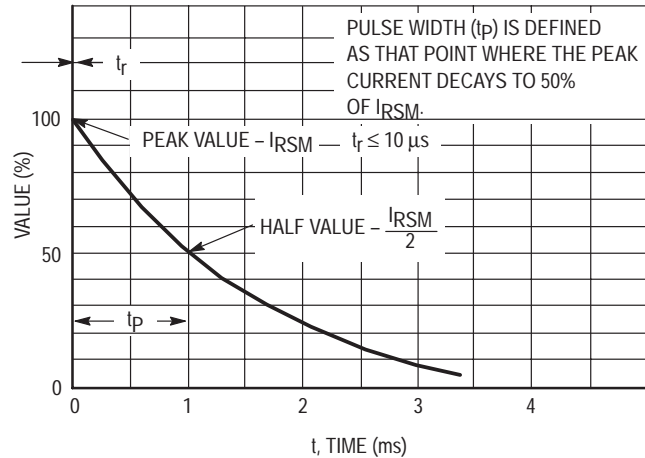
Rating	Symbol	Value	Unit
Peak Power Dissipation (1) @ $T_L \leq 25^\circ\text{C}$	$P_{PK}$	600	Watts
Forward Surge Current (2) @ $T_A = 25^\circ\text{C}$	$I_{FSM}$	100	Amps
Thermal Resistance from Junction to Lead (typical)	$R_{\theta JL}$	25	$^\circ\text{C/W}$
Operating and Storage Temperature Range	$T_J, T_{stg}$	- 65 to +150	$^\circ\text{C}$

NOTES: 1. Nonrepetitive current pulse per Figure 2 and derated above  $T_A = 25^\circ\text{C}$  per Figure 3.  
2. 1/2 sine wave (or equivalent square wave), PW = 8.3 ms, duty cycle = 4 pulses per minute maximum.

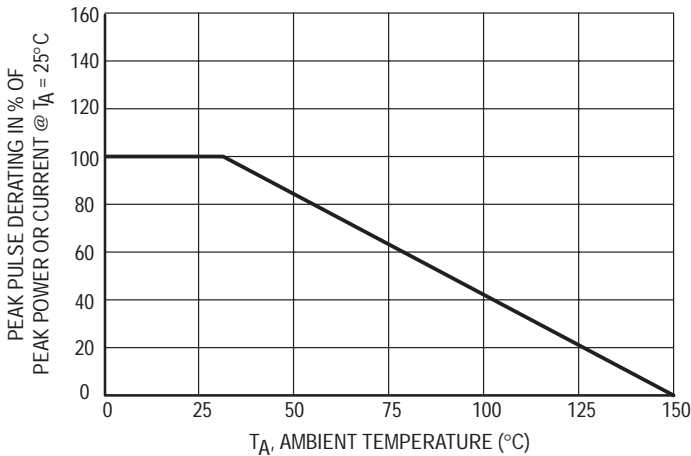
# GENERAL DATA — 600 WATT PEAK POWER



**Figure 1. Pulse Rating Curve**

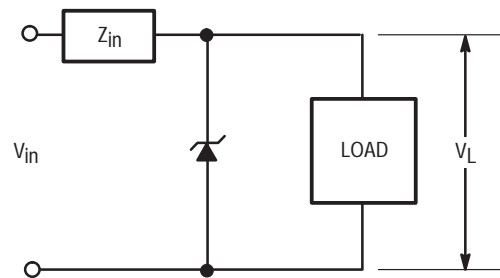


**Figure 2. Pulse Waveform**



**Figure 3. Pulse Derating Curve**

## TYPICAL PROTECTION CIRCUIT



## APPLICATION NOTES

### RESPONSE TIME

In most applications, the transient suppressor device is placed in parallel with the equipment or component to be protected. In this situation, there is a time delay associated with the capacitance of the device and an overshoot condition associated with the inductance of the device and the inductance of the connection method. The capacitive effect is of minor importance in the parallel protection scheme because it only produces a time delay in the transition from the operating voltage to the clamp voltage as shown in Figure 4.

The inductive effects in the device are due to actual turn-on time (time required for the device to go from zero current to full current) and lead inductance. This inductive effect produces an overshoot in the voltage across the equipment or component being protected as shown in Figure 5. Minimizing this overshoot is very important in the application, since the main purpose for adding a transient suppressor is to clamp voltage spikes. The SMB series have a very good response time, typically < 1 ns and negligible inductance. However, external inductive effects could produce unacceptable overshoot. Proper circuit layout, minimum lead lengths and placing

the suppressor device as close as possible to the equipment or components to be protected will minimize this overshoot.

Some input impedance represented by  $Z_{in}$  is essential to prevent overstress of the protection device. This impedance should be as high as possible, without restricting the circuit operation.

### DUTY CYCLE DERATING

The data of Figure 1 applies for non-repetitive conditions and at a lead temperature of 25°C. If the duty cycle increases, the peak power must be reduced as indicated by the curves of Figure 6. Average power must be derated as the lead or ambient temperature rises above 25°C. The average power derating curve normally given on data sheets may be normalized and used for this purpose.

At first glance the derating curves of Figure 6 appear to be in error as the 10 ms pulse has a higher derating factor than the 10 μs pulse. However, when the derating factor for a given pulse of Figure 6 is multiplied by the peak power value of Figure 1 for the same pulse, the results follow the expected trend.

## GENERAL DATA — 600 WATT PEAK POWER

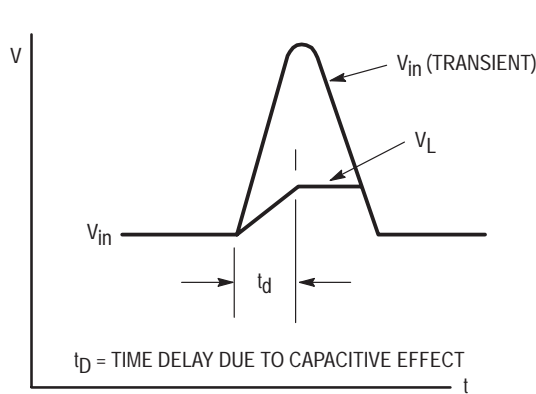


Figure 4.

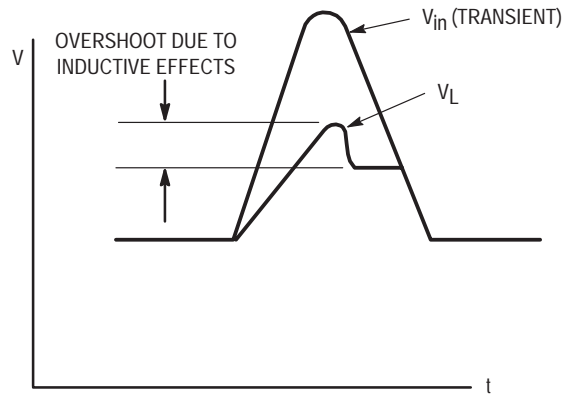


Figure 5.

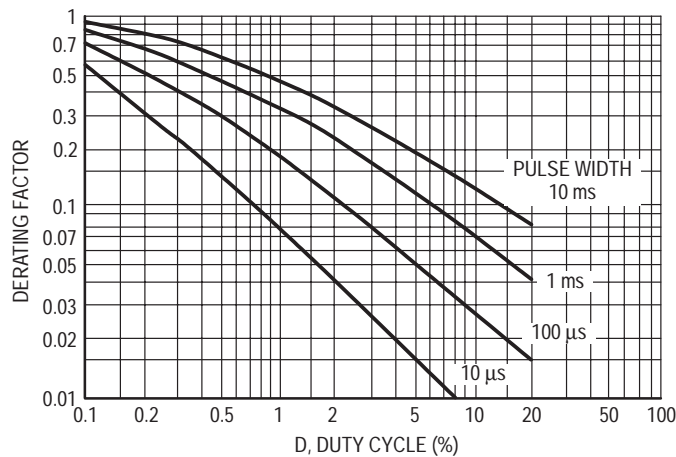


Figure 6. Typical Derating Factor for Duty Cycle

### UL RECOGNITION

The entire series has *Underwriters Laboratory Recognition* for the classification of protectors (QVGV2) under the UL standard for safety 497B and File #116110. Many competitors only have one or two devices recognized or have recognition in a non-protective category. Some competitors have no recognition at all. With the UL497B recognition, our parts successfully passed several tests including Strike Voltage

Breakdown test, Endurance Conditioning, Temperature test, Dielectric Voltage-Withstand test, Discharge test and several more.

Whereas, some competitors have only passed a flammability test for the package material, we have been recognized for much more to be included in their Protector category.

# 1SMB5.0AT3 through 1SMB170AT3

## ELECTRICAL CHARACTERISTICS (T<sub>A</sub> = 25°C unless otherwise noted).

Device††	Reverse Stand-Off Voltage V <sub>R</sub> Volts (1)	Breakdown Voltage*		Maximum Clamping Voltage V <sub>C</sub> @ I <sub>pp</sub> Volts	Peak Pulse Current (See Figure 2) I <sub>pp</sub> † Amps	Maximum Reverse Leakage @ V <sub>R</sub> I <sub>R</sub> μA	Device Marking
		V <sub>BR</sub> @ I <sub>T</sub> Volts Min	mA				
<b>1SMB5.0AT3</b>	<b>5.0</b>	<b>6.40</b>	<b>10</b>	<b>9.2</b>	<b>65.2</b>	<b>800</b>	<b>KE</b>
<b>1SMB6.0AT3</b>	<b>6.0</b>	<b>6.67</b>	<b>10</b>	<b>10.3</b>	<b>58.3</b>	<b>800</b>	<b>KG</b>
1SMB6.5AT3	6.5	7.22	10	11.2	53.6	500	KK
1SMB7.0AT3	7.0	7.78	10	12.0	50.0	200	KM
1SMB7.5AT3	7.5	8.33	1.0	12.9	46.5	100	KP
1SMB8.0AT3	8.0	8.89	1.0	13.6	44.1	50	KR
1SMB8.5AT3	8.5	9.44	1.0	14.4	41.7	10	KT
1SMB9.0AT3	9.0	10.0	1.0	15.4	39.0	5.0	KV
1SMB10AT3	10	11.1	1.0	17.0	35.3	5.0	KX
1SMB11AT3	11	12.2	1.0	18.2	33.0	5.0	KZ
1SMB12AT3	12	13.3	1.0	19.9	30.2	5.0	LE
1SMB13AT3	13	14.4	1.0	21.5	27.9	5.0	LG
1SMB14AT3	14	15.6	1.0	23.2	25.8	5.0	LK
1SMB15AT3	15	16.7	1.0	24.4	24.0	5.0	LM
1SMB16AT3	16	17.8	1.0	26.0	23.1	5.0	LP
1SMB17AT3	17	18.9	1.0	27.6	21.7	5.0	LR
1SMB18AT3	18	20.0	1.0	29.2	20.5	5.0	LT
1SMB20AT3	20	22.2	1.0	32.4	18.5	5.0	LV
<b>1SMB22AT3</b>	<b>22</b>	<b>24.4</b>	<b>1.0</b>	<b>35.5</b>	<b>16.9</b>	<b>5.0</b>	<b>LX</b>
1SMB24AT3	24	26.7	1.0	38.9	15.4	5.0	LZ
1SMB26AT3	26	28.9	1.0	42.1	14.2	5.0	ME
1SMB28AT3	28	31.1	1.0	45.4	13.2	5.0	MG
1SMB30AT3	30	33.3	1.0	48.4	12.4	5.0	MK
1SMB33AT3	33	36.7	1.0	53.3	11.3	5.0	MM
1SMB36AT3	36	40.0	1.0	58.1	10.3	5.0	MP
1SMB40AT3	40	44.4	1.0	64.5	9.3	5.0	MR
1SMB43AT3	43	47.8	1.0	69.4	8.6	5.0	MT
1SMB45AT3	45	50.0	1.0	72.7	8.3	5.0	MV
1SMB48AT3	48	53.3	1.0	77.4	7.7	5.0	MX
1SMB51AT3	51	56.7	1.0	82.4	7.3	5.0	MZ
1SMB54AT3	54	60.0	1.0	87.1	6.9	5.0	NE
<b>1SMB58AT3</b>	<b>58</b>	<b>64.4</b>	<b>1.0</b>	<b>93.6</b>	<b>6.4</b>	<b>5.0</b>	<b>NG</b>
1SMB60AT3	60	66.7	1.0	96.8	6.2	5.0	NK
1SMB64AT3	64	71.1	1.0	103	5.8	5.0	NM
1SMB70AT3	70	77.8	1.0	113	5.3	5.0	NP
1SMB75AT3	75	83.3	1.0	121	4.9	5.0	NR
1SMB78AT3	78	86.7	1.0	126	4.7	5.0	NT
1SMB85AT3	85	94.4	1.0	137	4.4	5.0	NV
1SMB90AT3	90	100	1.0	146	4.1	5.0	NX
1SMB100AT3	100	111	1.0	162	3.7	5.0	NZ
1SMB110AT3	110	122	1.0	177	3.4	5.0	PE
1SMB120AT3	120	133	1.0	193	3.1	5.0	PG
1SMB130AT3	130	144	1.0	209	2.9	5.0	PK
1SMB150AT3	150	167	1.0	243	2.5	5.0	PM
1SMB160AT3	160	178	1.0	259	2.3	5.0	PP
1SMB170AT3	170	189	1.0	275	2.2	5.0	PR

Note 1: A transient suppressor is normally selected according to the reverse "Stand Off Voltage" (V<sub>R</sub>) which should be equal to or greater than the DC or continuous peak operating voltage level.

\* V<sub>BR</sub> measured at pulse test current I<sub>T</sub> at an ambient temperature of 25°C.

† Surge current waveform per Figure 2 and derate per Figure 3 of the General Data — 600 Watt at the beginning of this group.

†† T3 suffix designates tape and reel of 2500 units.

### ABBREVIATIONS AND SYMBOLS

**V<sub>R</sub>** Stand Off Voltage. Applied reverse voltage to assure a non-conductive condition (See Note 1).

**V(BR)min** This is the minimum breakdown voltage the device will exhibit and is used to assure that conduction does not occur prior to this voltage level at 25°C.

**V<sub>C</sub>** Maximum Clamping Voltage. The maximum peak voltage appearing across the transient suppressor when

**I<sub>PP</sub>**  
**P<sub>P</sub>**  
**I<sub>R</sub>**

subjected to the peak pulse current in a one millisecond time interval. The peak pulse voltages are the combination of voltage rise due to both the series resistance and thermal rise.

Peak Pulse Current — See Figure 2

Peak Pulse Power

Reverse Leakage

Devices listed in bold, italic are Motorola preferred devices.

# 1SMB10CAT3 through 1SMB78CAT3

## Bi-Directional

### ELECTRICAL CHARACTERISTICS ( $T_A = 25^\circ\text{C}$ unless otherwise noted).

Device††	Reverse Stand-Off Voltage $V_R$ Volts (1)	Breakdown Voltage*		Maximum Clamping Voltage $V_C @ I_{pp}$ Volts	Peak Pulse Current (See Figure 2) $I_{pp}^\dagger$ Amps	Maximum Reverse Leakage @ $V_R$ $I_R$ $\mu\text{A}$	Device Marking
		$V_{BR} @ I_T$ Volts Min	mA				
1SMB10CAT3	10	11.1	1.0	17.0	35.3	5.0	KXC
1SMB11CAT3	11	12.2	1.0	18.2	33.0	5.0	KZC
1SMB12CAT3	12	13.3	1.0	19.9	30.2	5.0	LEC
1SMB13CAT3	13	14.4	1.0	21.5	27.9	5.0	LGC
1SMB14CAT3	14	15.6	1.0	23.2	25.8	5.0	LKC
<b>1SMB15CAT3</b>	<b>15</b>	<b>16.7</b>	<b>1.0</b>	<b>24.4</b>	<b>24.0</b>	<b>5.0</b>	<b>LMC</b>
1SMB16CAT3	16	17.8	1.0	26.0	23.1	5.0	LPC
1SMB17CAT3	17	18.9	1.0	27.6	21.7	5.0	LRC
1SMB18CAT3	18	20.0	1.0	29.2	20.5	5.0	LTC
1SMB20CAT3	20	22.2	1.0	32.4	18.5	5.0	LVC
1SMB22CAT3	22	24.4	1.0	35.5	16.9	5.0	LXC
1SMB24CAT3	24	26.7	1.0	38.9	15.4	5.0	LZC
1SMB26CAT3	26	28.9	1.0	42.1	14.2	5.0	MEC
1SMB28CAT3	28	31.1	1.0	45.4	13.2	5.0	MGC
1SMB30CAT3	30	33.3	1.0	48.4	12.4	5.0	MKC
1SMB33CAT3	33	36.7	1.0	53.3	11.3	5.0	MMC
1SMB36CAT3	36	40.0	1.0	58.1	10.3	5.0	MPC
1SMB40CAT3	40	44.4	1.0	64.5	9.3	5.0	MRC
1SMB43CAT3	43	47.8	1.0	69.4	8.6	5.0	MTC
1SMB45CAT3	45	50.0	1.0	72.7	8.3	5.0	MVC
1SMB48CAT3	48	53.3	1.0	77.4	7.7	5.0	MXC
1SMB51CAT3	51	56.7	1.0	82.4	7.3	5.0	MZC
1SMB54CAT3	54	60.0	1.0	87.1	6.9	5.0	NEC
1SMB58CAT3	58	64.4	1.0	93.6	6.4	5.0	NGC
1SMB60CAT3	60	66.7	1.0	96.8	6.2	5.0	NKC
1SMB64CAT3	64	71.1	1.0	103	5.8	5.0	NMC
1SMB70CAT3	70	77.8	1.0	113	5.3	5.0	NPC
1SMB75CAT3	75	83.3	1.0	121	4.9	5.0	NRC
1SMB78CAT3	78	86.7	1.0	126	4.7	5.0	NTC

Note 1: A transient suppressor is normally selected according to the reverse "Stand Off Voltage" ( $V_R$ ) which should be equal to or greater than the DC or continuous peak operating voltage level.

\*  $V_{BR}$  measured at pulse test current  $I_T$  at an ambient temperature of  $25^\circ\text{C}$ .

† Surge current waveform per Figure 2 and derate per Figure 3 of the General Data — 600 Watt at the beginning of this group.

†† T3 suffix designates tape and reel of 2500 units.

### ABBREVIATIONS AND SYMBOLS

$V_R$  Stand Off Voltage. Applied reverse voltage to assure a non-conductive condition (See Note 1).

$V_{(BR)min}$  This is the minimum breakdown voltage the device will exhibit and is used to assure that conduction does not occur prior to this voltage level at  $25^\circ\text{C}$ .

$V_C$  Maximum Clamping Voltage. The maximum peak voltage appearing across the transient suppressor when

subjected to the peak pulse current in a one millisecond time interval. The peak pulse voltages are the combination of voltage rise due to both the series resistance and thermal rise.

$I_{pp}$  Peak Pulse Current — See Figure 2

$P_p$  Peak Pulse Power

$I_R$  Reverse Leakage

Devices listed in bold, italic are Motorola preferred devices.

# P6SMB6.8AT3 through P6SMB200AT3

**ELECTRICAL CHARACTERISTICS** ( $T_A = 25^\circ\text{C}$  unless otherwise noted)  $V_F = 3.5\text{ V Max}$ ,  $I_F^{**} = 50\text{ A}$  for all types.

Device††	Breakdown Voltage*				Working Peak Reverse Voltage $V_{RWM}$ Volts	Maximum Reverse Leakage @ $V_{RWM}$ $I_R$ $\mu\text{A}$	Maximum Reverse Surge Current $I_{RSM}^\dagger$ Amps	Maximum Reverse Voltage @ $I_{RSM}$ (Clamping Voltage) $V_{RSM}$ Volts	Maximum Temperature Coefficient of $V_{BR}$ $\%/^\circ\text{C}$	Device Marking
	$V_{BR}$ @ $I_T$ Volts									
	Min	Nom	Max	mA						
<b>P6SMB6.8AT3</b>	<b>6.45</b>	<b>6.8</b>	<b>7.14</b>	<b>10</b>	<b>5.8</b>	<b>1000</b>	<b>57</b>	<b>10.5</b>	<b>0.057</b>	<b>6V8A</b>
<b>P6SMB7.5AT3</b>	<b>7.13</b>	<b>7.5</b>	<b>7.88</b>	<b>10</b>	<b>6.4</b>	<b>500</b>	<b>53</b>	<b>11.3</b>	<b>0.061</b>	<b>7V5A</b>
P6SMB8.2AT3	7.79	8.2	8.61	10	7.02	200	50	12.1	0.065	8V2A
P6SMB9.1AT3	8.65	9.1	9.55	1	7.78	50	45	13.4	0.068	9V1A
<b>P6SMB10AT3</b>	<b>9.5</b>	<b>10</b>	<b>10.5</b>	<b>1</b>	<b>8.55</b>	<b>10</b>	<b>41</b>	<b>14.5</b>	<b>0.073</b>	<b>10A</b>
P6SMB11AT3	10.5	11	11.6	1	9.4	5	38	15.6	0.075	11A
P6SMB12AT3	11.4	12	12.6	1	10.2	5	36	16.7	0.078	12A
<b>P6SMB13AT3</b>	<b>12.4</b>	<b>13</b>	<b>13.7</b>	<b>1</b>	<b>11.1</b>	<b>5</b>	<b>33</b>	<b>18.2</b>	<b>0.081</b>	<b>13A</b>
<b>P6SMB15AT3</b>	<b>14.3</b>	<b>15</b>	<b>15.8</b>	<b>1</b>	<b>12.8</b>	<b>5</b>	<b>28</b>	<b>21.2</b>	<b>0.084</b>	<b>15A</b>
<b>P6SMB16AT3</b>	<b>15.2</b>	<b>16</b>	<b>16.8</b>	<b>1</b>	<b>13.6</b>	<b>5</b>	<b>27</b>	<b>22.5</b>	<b>0.086</b>	<b>16A</b>
<b>P6SMB18AT3</b>	<b>17.1</b>	<b>18</b>	<b>18.9</b>	<b>1</b>	<b>15.3</b>	<b>5</b>	<b>24</b>	<b>25.2</b>	<b>0.088</b>	<b>18A</b>
<b>P6SMB20AT3</b>	<b>19</b>	<b>20</b>	<b>21</b>	<b>1</b>	<b>17.1</b>	<b>5</b>	<b>22</b>	<b>27.7</b>	<b>0.09</b>	<b>20A</b>
<b>P6SMB22AT3</b>	<b>20.9</b>	<b>22</b>	<b>23.1</b>	<b>1</b>	<b>18.8</b>	<b>5</b>	<b>20</b>	<b>30.6</b>	<b>0.092</b>	<b>22A</b>
P6SMB24AT3	22.8	24	25.2	1	20.5	5	18	33.2	0.094	24A
<b>P6SMB27AT3</b>	<b>25.7</b>	<b>27</b>	<b>28.4</b>	<b>1</b>	<b>23.1</b>	<b>5</b>	<b>16</b>	<b>37.5</b>	<b>0.096</b>	<b>27A</b>
<b>P6SMB30AT3</b>	<b>28.5</b>	<b>30</b>	<b>31.5</b>	<b>1</b>	<b>25.6</b>	<b>5</b>	<b>14.4</b>	<b>41.4</b>	<b>0.097</b>	<b>30A</b>
P6SMB33AT3	31.4	33	34.7	1	28.2	5	13.2	45.7	0.098	33A
<b>P6SMB36AT3</b>	<b>34.2</b>	<b>36</b>	<b>37.8</b>	<b>1</b>	<b>30.8</b>	<b>5</b>	<b>12</b>	<b>49.9</b>	<b>0.099</b>	<b>36A</b>
<b>P6SMB39AT3</b>	<b>37.1</b>	<b>39</b>	<b>41</b>	<b>1</b>	<b>33.3</b>	<b>5</b>	<b>11.2</b>	<b>53.9</b>	<b>0.1</b>	<b>39A</b>
P6SMB43AT3	40.9	43	45.2	1	36.8	5	10.1	59.3	0.101	43A
P6SMB47AT3	44.7	47	49.4	1	40.2	5	9.3	64.8	0.101	47A
<b>P6SMB51AT3</b>	<b>48.5</b>	<b>51</b>	<b>53.6</b>	<b>1</b>	<b>43.6</b>	<b>5</b>	<b>8.6</b>	<b>70.1</b>	<b>0.102</b>	<b>51A</b>
P6SMB56AT3	53.2	56	58.8	1	47.8	5	7.8	77	0.103	56A
P6SMB62AT3	58.9	62	65.1	1	53	5	7.1	85	0.104	62A
P6SMB68AT3	64.6	68	71.4	1	58.1	5	6.5	92	0.104	68A
P6SMB75AT3	71.3	75	78.8	1	64.1	5	5.8	103	0.105	75A
P6SMB82AT3	77.9	82	86.1	1	70.1	5	5.3	113	0.105	82A
P6SMB91AT3	86.5	91	95.5	1	77.8	5	4.8	125	0.106	91A
P6SMB100AT3	95	100	105	1	85.5	5	4.4	137	0.106	100A
P6SMB110AT3	105	110	116	1	94	5	4	152	0.107	110A
P6SMB120AT3	114	120	126	1	102	5	3.6	165	0.107	120A
P6SMB130AT3	124	130	137	1	111	5	3.3	179	0.107	130A
P6SMB150AT3	143	150	158	1	128	5	2.9	207	0.108	150A
<b>P6SMB160AT3</b>	<b>152</b>	<b>160</b>	<b>168</b>	<b>1</b>	<b>136</b>	<b>5</b>	<b>2.7</b>	<b>219</b>	<b>0.108</b>	<b>160A</b>
P6SMB170AT3	162	170	179	1	145	5	2.6	234	0.108	170A
P6SMB180AT3	171	180	189	1	154	5	2.4	246	0.108	180A
P6SMB200AT3	190	200	210	1	171	5	2.2	274	0.108	200A

\*  $V_{BR}$  measured at pulse test current  $I_T$  at an ambient temperature of  $25^\circ\text{C}$ .

\*\* 1/2 sine wave (or equivalent square wave),  $PW = 8.3\text{ ms}$ , duty cycle = 4 pulses per minute maximum.

† Surge current waveform per Figure 2 and derate per Figure 3 of the General Data — 600 Watt at the beginning of this group.

†† T3 suffix designates tape and reel of 2500 units.

Devices listed in bold, italic are Motorola preferred devices.



# P6SMB11CAT3 through P6SMB91CAT3

## Bi-Directional

ELECTRICAL CHARACTERISTICS ( $T_A = 25^\circ\text{C}$  unless otherwise noted)  $V_F = 3.5\text{ V Max}$ ,  $I_F^{**} = 50\text{ A}$  for all types.

Device††	Breakdown Voltage*				Working Peak Reverse Voltage $V_{RWM}$ Volts	Maximum Reverse Leakage @ $V_{RWM}$ $I_R$ $\mu\text{A}$	Maximum Reverse Surge Current $I_{RSM}^\dagger$ Amps	Maximum Reverse Voltage @ $I_{RSM}$ (Clamping Voltage) $V_{RSM}$ Volts	Maximum Temperature Coefficient of $V_{BR}$ %/°C	Device Marking
	$V_{BR}$ @ $I_T$ Volts									
	Min	Nom	Max	mA						
P6SMB11CAT3	10.5	11	11.6	1	9.4	5	38	15.6	0.075	11C
P6SMB12CAT3	11.4	12	12.6	1	10.2	5	36	16.7	0.078	12C
P6SMB13CAT3	12.4	13	13.7	1	11.1	5	33	18.2	0.081	13C
P6SMB15CAT3	14.3	15	15.8	1	12.8	5	28	21.2	0.084	15C
P6SMB16CAT3	15.2	16	16.8	1	13.6	5	27	22.5	0.086	16C
P6SMB18CAT3	17.1	18	18.9	1	15.3	5	24	25.2	0.088	18C
P6SMB20CAT3	19	20	21	1	17.1	5	22	27.7	0.09	20C
P6SMB22CAT3	20.9	22	23.1	1	18.8	5	20	30.6	0.092	22C
P6SMB24CAT3	22.8	24	25.2	1	20.5	5	18	33.2	0.094	24C
P6SMB27CAT3	25.7	27	28.4	1	23.1	5	16	37.5	0.096	27C
P6SMB30CAT3	28.5	30	31.5	1	25.6	5	14.4	41.4	0.097	30C
<b><i>P6SMB33CAT3</i></b>	<b><i>31.4</i></b>	<b><i>33</i></b>	<b><i>34.7</i></b>	<b><i>1</i></b>	<b><i>28.2</i></b>	<b><i>5</i></b>	<b><i>13.2</i></b>	<b><i>45.7</i></b>	<b><i>0.098</i></b>	<b><i>33C</i></b>
P6SMB36CAT3	34.2	36	37.8	1	30.8	5	12	49.9	0.099	36C
P6SMB39CAT3	37.1	39	41	1	33.3	5	11.2	53.9	0.1	39C
P6SMB43CAT3	40.9	43	45.2	1	36.8	5	10.1	59.3	0.101	43C
P6SMB47CAT3	44.7	47	49.4	1	40.2	5	9.3	64.8	0.101	47C
P6SMB51CAT3	48.5	51	53.6	1	43.6	5	8.6	70.1	0.102	51C
P6SMB56CAT3	53.2	56	58.8	1	47.8	5	7.8	77	0.103	56C
P6SMB62CAT3	58.9	62	65.1	1	53	5	7.1	85	0.104	62C
P6SMB68CAT3	64.6	68	71.4	1	58.1	5	6.5	92	0.104	68C
P6SMB75CAT3	71.3	75	78.8	1	64.1	5	5.8	103	0.105	75C
P6SMB82CAT3	77.9	82	86.1	1	70.1	5	5.3	113	0.105	82C
P6SMB91CAT3	86.5	91	95.5	1	77.8	5	4.8	125	0.106	91C

\*  $V_{BR}$  measured at pulse test current  $I_T$  at an ambient temperature of  $25^\circ\text{C}$ .

\*\* 1/2 sine wave (or equivalent square wave),  $PW = 8.3\text{ ms}$ , duty cycle = 4 pulses per minute maximum.

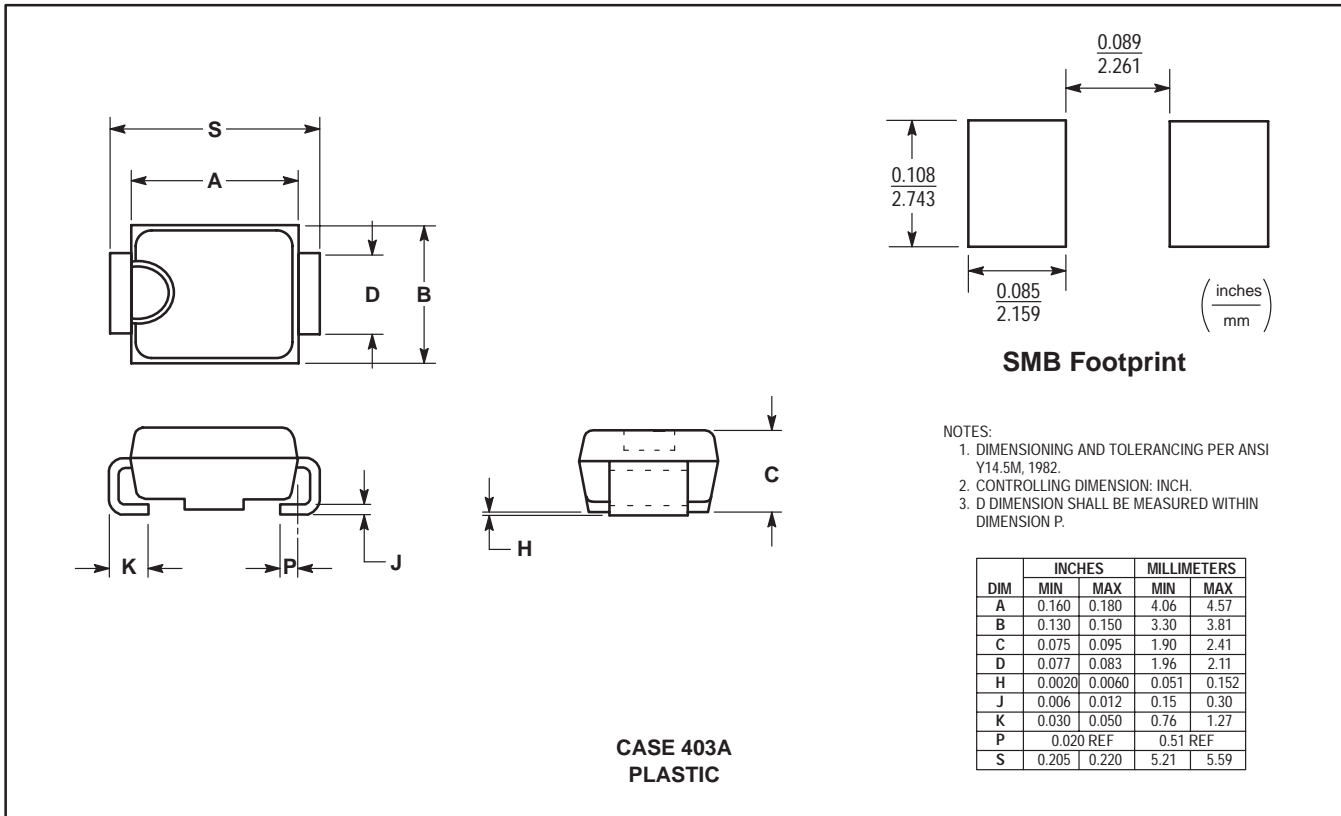
† Surge current waveform per Figure 2 and derate per Figure 3 of the General Data — 600 Watt at the beginning of this group.

†† T3 suffix designates tape and reel of 2500 units.

Devices listed in bold, italic are Motorola preferred devices.

# Transient Voltage Suppressors — Surface Mounted

## 600 Watt Peak Power



(Refer to Section 10 for Surface Mount, Thermal Data and Footprint Information.)

### MULTIPLE PACKAGE QUANTITY (MPQ) REQUIREMENTS

Package Option	Type No. Suffix	MPQ (Units)
Tape and Reel	T3 (13 inch reel)	2.5K

(Refer to Section 10 for more information on Packaging Specifications.)

**GENERAL DATA APPLICABLE TO ALL SERIES IN  
THIS GROUP**

**Zener Transient Voltage Suppressors**

The SMC series is designed to protect voltage sensitive components from high voltage, high energy transients. They have excellent clamping capability, high surge capability, low zener impedance and fast response time. The SMC series is supplied in Motorola's exclusive, cost-effective, highly reliable Surmetic package and is ideally suited for use in communication systems, numerical controls, process controls, medical equipment, business machines, power supplies and many other industrial/consumer applications.

**Specification Features:**

- Standard Zener Breakdown Voltage Range — 6.8 to 91 V
- Stand-off Voltage Range — 5 to 78 V
- Peak Power — 1500 Watts @ 1 ms
- Maximum Clamp Voltage @ Peak Pulse Current
- Low Leakage < 5  $\mu$ A Above 10 V
- UL Recognition
- Maximum Temperature Coefficient Specified
- Available in Tape and Reel
- Response Time Typically < 1 ns

**Mechanical Characteristics:**

**CASE:** Void-free, transfer-molded, thermosetting plastic

**FINISH:** All external surfaces are corrosion resistant and leads are readily solderable

**POLARITY:** Cathode indicated by molded polarity notch. When operated in zener mode, will be positive with respect to anode

**MOUNTING POSITION:** Any

**LEADS:** Modified L-Bend providing more contact area to bond pads

**MAXIMUM CASE TEMPERATURE FOR SOLDERING PURPOSES:** 260°C for 10 seconds

**WAFER FAB LOCATION:** Phoenix, Arizona

**ASSEMBLY/TEST LOCATION:** Seremban, Malaysia

**GENERAL  
DATA  
1500 WATT  
PEAK POWER**

**PLASTIC SURFACE MOUNT  
ZENER OVERVOLTAGE  
TRANSIENT  
SUPPRESSORS  
6.8–91 VOLTS  
1500 WATT PEAK POWER**



**CASE 403  
PLASTIC**

**MAXIMUM RATINGS**

Rating	Symbol	Value	Unit
Peak Power Dissipation (1) @ $T_L \leq 25^\circ\text{C}$	P <sub>PK</sub>	1500	Watts
Forward Surge Current (2) @ $T_A = 25^\circ\text{C}$	I <sub>FSM</sub>	200	Amps
Thermal Resistance from Junction to Lead (typical)	R <sub><math>\theta</math>JL</sub>	15	$^\circ\text{C}/\text{W}$
Operating and Storage Temperature Range	T <sub>J</sub> , T <sub>stg</sub>	- 65 to +150	$^\circ\text{C}$

NOTES: 1. Nonrepetitive current pulse per Figure 2 and derated above  $T_A = 25^\circ\text{C}$  per Figure 3.  
2. 1/2 sine wave (or equivalent square wave), PW = 8.3 ms, duty cycle = 4 pulses per minute maximum.

# GENERAL DATA — 1500 WATT PEAK POWER

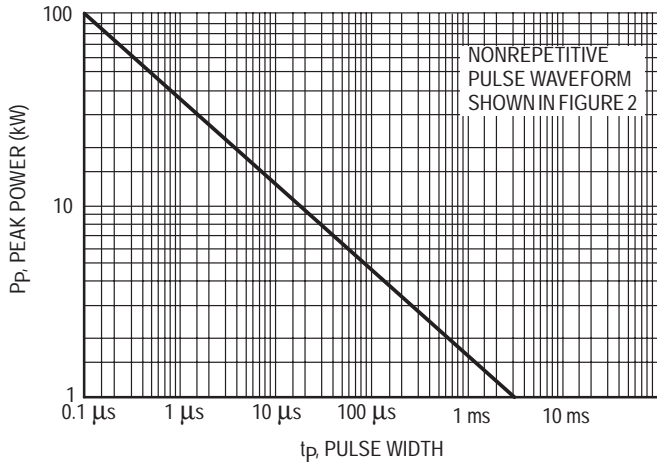


Figure 1. Pulse Rating Curve

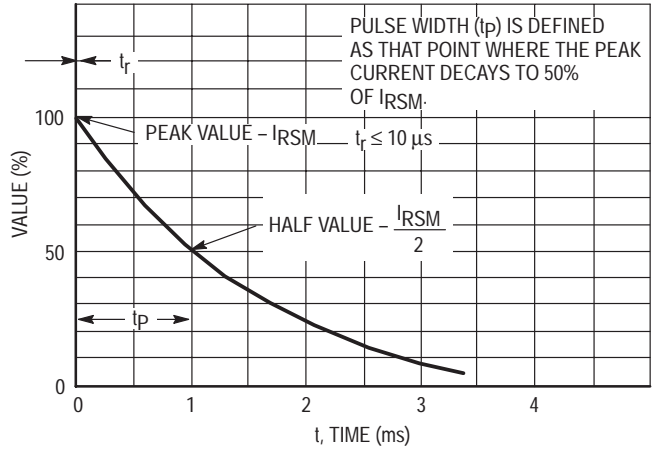


Figure 2. Pulse Waveform

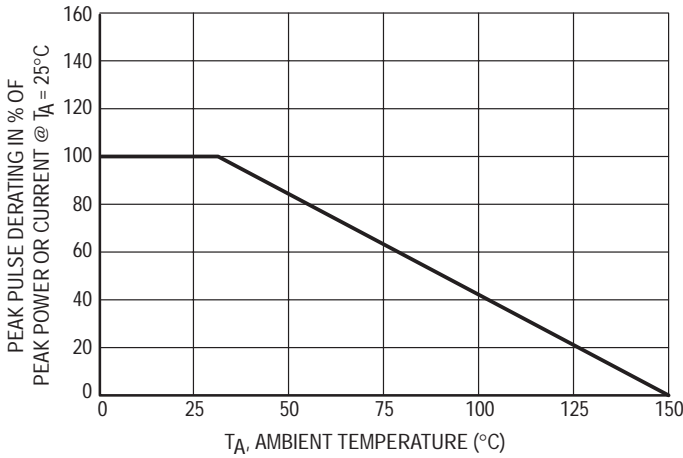


Figure 3. Pulse Derating Curve

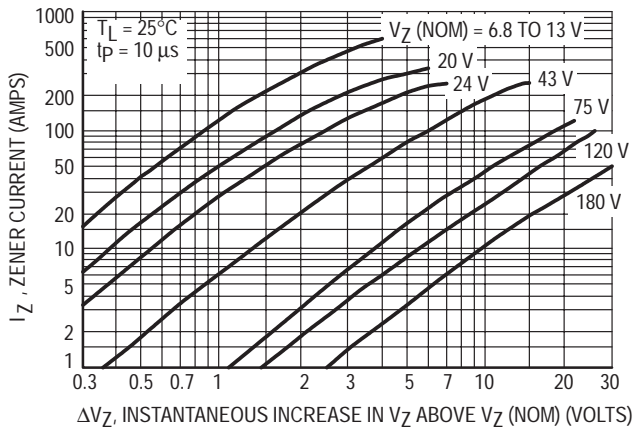


Figure 4. Dynamic Impedance

## UL RECOGNITION

The entire series has *Underwriters Laboratory Recognition* for the classification of protectors (QVG2) under the UL standard for safety 497B and File #116110. Many competitors only have one or two devices recognized or have recognition in a non-protective category. Some competitors have no recognition at all. With the UL497B recognition, our parts successfully passed several tests including Strike Voltage

Breakdown test, Endurance Conditioning, Temperature test, Dielectric Voltage-Withstand test, Discharge test and several more.

Whereas, some competitors have only passed a flammability test for the package material, we have been recognized for much more to be included in their Protector category.

# GENERAL DATA — 1500 WATT PEAK POWER

## APPLICATION NOTES

### RESPONSE TIME

In most applications, the transient suppressor device is placed in parallel with the equipment or component to be protected. In this situation, there is a time delay associated with the capacitance of the device and an overshoot condition associated with the inductance of the device and the inductance of the connection method. The capacitive effect is of minor importance in the parallel protection scheme because it only produces a time delay in the transition from the operating voltage to the clamp voltage as shown in Figure 5.

The inductive effects in the device are due to actual turn-on time (time required for the device to go from zero current to full current) and lead inductance. This inductive effect produces an overshoot in the voltage across the equipment or component being protected as shown in Figure 6. Minimizing this overshoot is very important in the application, since the main purpose for adding a transient suppressor is to clamp voltage spikes. The SMC series have a very good response time, typically  $< 1$  ns and negligible inductance. However, external inductive effects could produce unacceptable overshoot. Proper circuit layout, minimum lead lengths and placing the

suppressor device as close as possible to the equipment or components to be protected will minimize this overshoot.

Some input impedance represented by  $Z_{in}$  is essential to prevent overstress of the protection device. This impedance should be as high as possible, without restricting the circuit operation.

### DUTY CYCLE DERATING

The data of Figure 1 applies for non-repetitive conditions and at a lead temperature of  $25^{\circ}\text{C}$ . If the duty cycle increases, the peak power must be reduced as indicated by the curves of Figure 7. Average power must be derated as the lead or ambient temperature rises above  $25^{\circ}\text{C}$ . The average power derating curve normally given on data sheets may be normalized and used for this purpose.

At first glance the derating curves of Figure 7 appear to be in error as the 10 ms pulse has a higher derating factor than the 10  $\mu\text{s}$  pulse. However, when the derating factor for a given pulse of Figure 7 is multiplied by the peak power value of Figure 1 for the same pulse, the results follow the expected trend.

### TYPICAL PROTECTION CIRCUIT

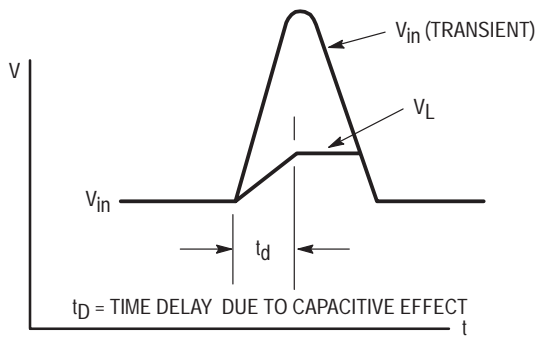
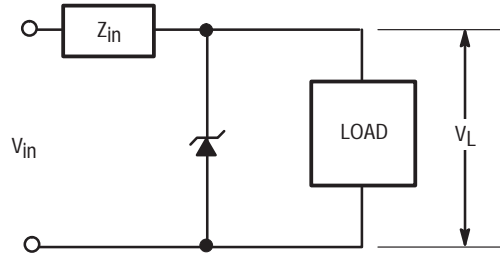


Figure 5.

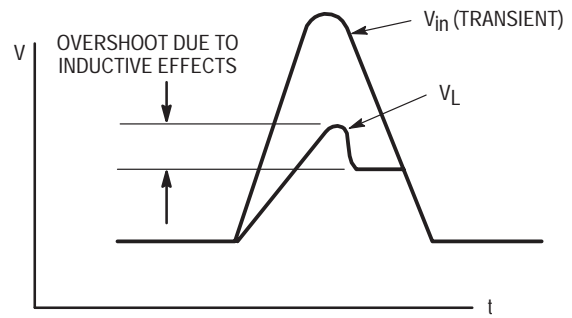


Figure 6.

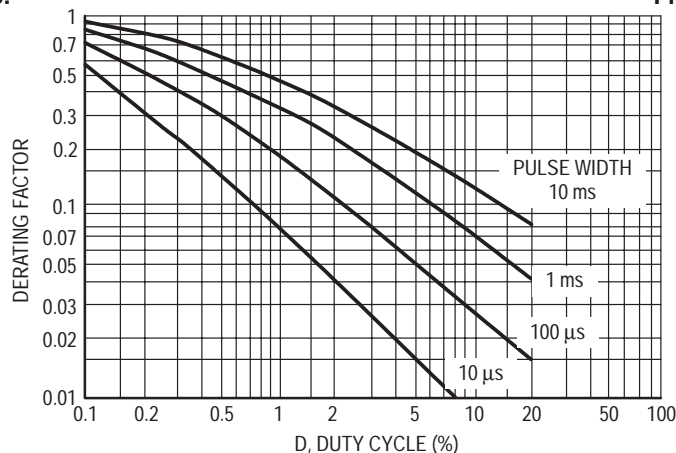


Figure 7. Typical Derating Factor for Duty Cycle

# 1SMC5.0AT3 through 1SMC78AT3

## ELECTRICAL CHARACTERISTICS ( $T_A = 25^\circ\text{C}$ unless otherwise noted).

Device††	Reverse Stand-Off Voltage $V_R$ Volts (1)	Breakdown Voltage*		Maximum Clamping Voltage $V_C$ @ $I_{pp}$ Volts	Peak Pulse Current (See Figure 2) $I_{pp}^\dagger$ Amps	Maximum Reverse Leakage @ $V_R$ $I_R$ $\mu\text{A}$	Device Marking
		$V_{BR}$ @ $I_T$					
		Volts Min	mA				
1SMC5.0AT3	5.0	6.40	10	9.2	163.0	1000	GDE
1SMC6.0AT3	6.0	6.67	10	10.3	145.6	1000	GDG
1SMC6.5AT3	6.5	7.22	10	11.2	133.9	500	GDK
1SMC7.0AT3	7.0	7.78	10	12.0	125.0	200	GDM
1SMC7.5AT3	7.5	8.33	1.0	12.9	116.3	100	GDP
1SMC8.0AT3	8.0	8.89	1.0	13.6	110.3	50	GDR
1SMC8.5AT3	8.5	9.44	1.0	14.4	104.2	20	GDT
1SMC9.0AT3	9.0	10.0	1.0	15.4	97.4	10	GDV
1SMC10AT3	10	11.1	1.0	17.0	88.2	5.0	GDX
1SMC11AT3	11	12.2	1.0	18.2	82.4	5.0	GDZ
1SMC12AT3	12	13.3	1.0	19.9	75.3	5.0	GEE
1SMC13AT3	13	14.4	1.0	21.5	69.7	5.0	GEG
1SMC14AT3	14	15.6	1.0	23.2	64.7	5.0	GEK
1SMC15AT3	15	16.7	1.0	24.4	61.5	5.0	GEM
1SMC16AT3	16	17.8	1.0	26.0	57.7	5.0	GEP
1SMC17AT3	17	18.9	1.0	27.6	53.3	5.0	GER
1SMC18AT3	18	20.0	1.0	29.2	51.4	5.0	GET
1SMC20AT3	20	22.2	1.0	32.4	46.3	5.0	GEV
1SMC22AT3	22	24.4	1.0	35.5	42.2	5.0	GEX
1SMC24AT3	24	26.7	1.0	38.9	38.6	5.0	GEZ
1SMC26AT3	26	28.9	1.0	42.1	35.6	5.0	GFE
1SMC28AT3	28	31.1	1.0	45.4	33.0	5.0	GFG
1SMC30AT3	30	33.3	1.0	48.4	31.0	5.0	GFK
1SMC33AT3	33	36.7	1.0	53.3	28.1	5.0	GFM
1SMC36AT3	36	40.0	1.0	58.1	25.8	5.0	GFP
1SMC40AT3	40	44.4	1.0	64.5	23.2	5.0	GFR
1SMC43AT3	43	47.8	1.0	69.4	21.6	5.0	GFT
1SMC45AT3	45	50.0	1.0	72.7	20.6	5.0	GFV
1SMC48AT3	48	53.3	1.0	77.4	19.4	5.0	GFX
1SMC51AT3	51	56.7	1.0	82.4	18.2	5.0	GFZ
1SMC54AT3	54	60.0	1.0	87.1	17.2	5.0	GGE
<b>1SMC58AT3</b>	<b>58</b>	<b>64.4</b>	<b>1.0</b>	<b>93.6</b>	<b>16.0</b>	<b>5.0</b>	<b>GGG</b>
1SMC60AT3	60	66.7	1.0	96.8	15.5	5.0	GGK
1SMC64AT3	64	71.1	1.0	103	14.6	5.0	GGM
1SMC70AT3	70	77.8	1.0	113	13.3	5.0	GGP
1SMC75AT3	75	83.3	1.0	121	12.4	5.0	GGR
1SMC78AT3	78	86.7	1.0	126	11.4	5.0	GGT

Note 1: A transient suppressor is normally selected according to the reverse "Stand Off Voltage" ( $V_R$ ) which should be equal to or greater than the DC or continuous peak operating voltage level.

\*  $V_{BR}$  measured at pulse test current  $I_T$  at an ambient temperature of  $25^\circ\text{C}$ .

† Surge current waveform per Figure 2 and derate per Figure 3 of the General Data — 1500 Watt at the beginning of this group.

†† T3 suffix designates tape and reel of 2500 units.

### ABBREVIATIONS AND SYMBOLS

$V_R$  Stand Off Voltage. Applied reverse voltage to assure a non-conductive condition (See Note 1).

$V_{(BR)min}$  This is the minimum breakdown voltage the device will exhibit and is used to assure that conduction does not occur prior to this voltage level at  $25^\circ\text{C}$ .

$V_C$  Maximum Clamping Voltage. The maximum peak voltage appearing across the transient suppressor when

subjected to the peak pulse current in a one millisecond time interval. The peak pulse series resistance and thermal rise.

$I_{pp}$  Peak Pulse Current — See Figure 2

$P_p$  Peak Pulse Power

$I_R$  Reverse Leakage

Devices listed in bold, italic are Motorola preferred devices.

# 1.5SMC6.8AT3 through 1.5SMC91AT3

ELECTRICAL CHARACTERISTICS ( $T_A = 25^\circ\text{C}$  unless otherwise noted)  $V_F = 3.5\text{ V Max}$ ,  $I_F^{**} = 100\text{ A}$  for all types.

Device††	Breakdown Voltage*				Working Peak Reverse Voltage $V_{RWM}$ Volts	Maximum Reverse Leakage @ $V_{RWM}$ $I_R$ $\mu\text{A}$	Maximum Reverse Surge Current $I_{RSM}^\dagger$ Amps	Maximum Reverse Voltage @ $I_{RSM}$ (Clamping Voltage) $V_{RSM}$ Volts	Maximum Temperature Coefficient of $V_{BR}$ %/°C	Device Marking
	$V_{BR}$ @ $I_T$ Volts									
	Min	Nom	Max	mA						
1.5SMC6.8AT3	6.45	6.8	7.14	10	5.8	1000	143	10.5	0.057	6V8A
1.5SMC7.5AT3	7.13	7.5	7.88	10	6.4	500	132	11.3	0.061	7V5A
1.5SMC8.2AT3	7.79	8.2	8.61	10	7.02	200	124	12.1	0.065	8V2A
1.5SMC9.1AT3	8.65	9.1	9.55	1	7.78	50	112	13.4	0.068	9V1A
1.5SMC10AT3	9.5	10	10.5	1	8.55	10	103	14.5	0.073	10A
1.5SMC11AT3	10.5	11	11.6	1	9.4	5	96	15.6	0.075	11A
1.5SMC12AT3	11.4	12	12.6	1	10.2	5	90	16.7	0.078	12A
1.5SMC13AT3	12.4	13	13.7	1	11.1	5	82	18.2	0.081	13A
<b>1.5SMC15AT3</b>	<b>14.3</b>	<b>15</b>	<b>15.8</b>	<b>1</b>	<b>12.8</b>	<b>5</b>	<b>71</b>	<b>21.2</b>	<b>0.084</b>	<b>15A</b>
1.5SMC16AT3	15.2	16	16.8	1	13.6	5	67	22.5	0.086	16A
1.5SMC18AT3	17.1	18	18.9	1	15.3	5	59.5	25.2	0.088	18A
1.5SMC20AT3	19	20	21	1	17.1	5	54	27.7	0.09	20A
1.5SMC22AT3	20.9	22	23.1	1	18.8	5	49	30.6	0.092	22A
<b>1.5SMC24AT3</b>	<b>22.8</b>	<b>24</b>	<b>25.2</b>	<b>1</b>	<b>20.5</b>	<b>5</b>	<b>45</b>	<b>33.2</b>	<b>0.094</b>	<b>24A</b>
1.5SMC27AT3	25.7	27	28.4	1	23.1	5	40	37.5	0.096	27A
1.5SMC30AT3	28.5	30	31.5	1	25.6	5	36	41.4	0.097	30A
<b>1.5SMC33AT3</b>	<b>31.4</b>	<b>33</b>	<b>34.7</b>	<b>1</b>	<b>28.2</b>	<b>5</b>	<b>33</b>	<b>45.7</b>	<b>0.098</b>	<b>33A</b>
<b>1.5SMC36AT3</b>	<b>34.2</b>	<b>36</b>	<b>37.8</b>	<b>1</b>	<b>30.8</b>	<b>5</b>	<b>30</b>	<b>49.9</b>	<b>0.099</b>	<b>36A</b>
<b>1.5SMC39AT3</b>	<b>37.1</b>	<b>39</b>	<b>41</b>	<b>1</b>	<b>33.3</b>	<b>5</b>	<b>28</b>	<b>53.9</b>	<b>0.1</b>	<b>39A</b>
<b>1.5SMC43AT3</b>	<b>40.9</b>	<b>43</b>	<b>45.2</b>	<b>1</b>	<b>36.8</b>	<b>5</b>	<b>25.3</b>	<b>59.3</b>	<b>0.101</b>	<b>43A</b>
<b>1.5SMC47AT3</b>	<b>44.7</b>	<b>47</b>	<b>49.4</b>	<b>1</b>	<b>40.2</b>	<b>5</b>	<b>23.2</b>	<b>64.8</b>	<b>0.101</b>	<b>47A</b>
1.5SMC51AT3	48.5	51	53.6	1	43.6	5	21.4	70.1	0.102	51A
1.5SMC56AT3	53.2	56	58.8	1	47.8	5	19.5	77	0.103	56A
1.5SMC62AT3	58.9	62	65.1	1	53	5	17.7	85	0.104	62A
1.5SMC68AT3	64.6	68	71.4	1	58.1	5	16.3	92	0.104	68A
<b>1.5SMC75AT3</b>	<b>71.3</b>	<b>75</b>	<b>78.8</b>	<b>1</b>	<b>64.1</b>	<b>5</b>	<b>14.6</b>	<b>103</b>	<b>0.105</b>	<b>75A</b>
1.5SMC82AT3	77.9	82	86.1	1	70.1	5	13.3	113	0.105	82A
1.5SMC91AT3	86.5	91	95.5	1	77.8	5	12	125	0.106	91A

\*  $V_{BR}$  measured at pulse test current  $I_T$  at an ambient temperature of  $25^\circ\text{C}$ .

\*\* 1/2 sine wave (or equivalent square wave),  $PW = 8.3\text{ ms}$ , duty cycle = 4 pulses per minute maximum.

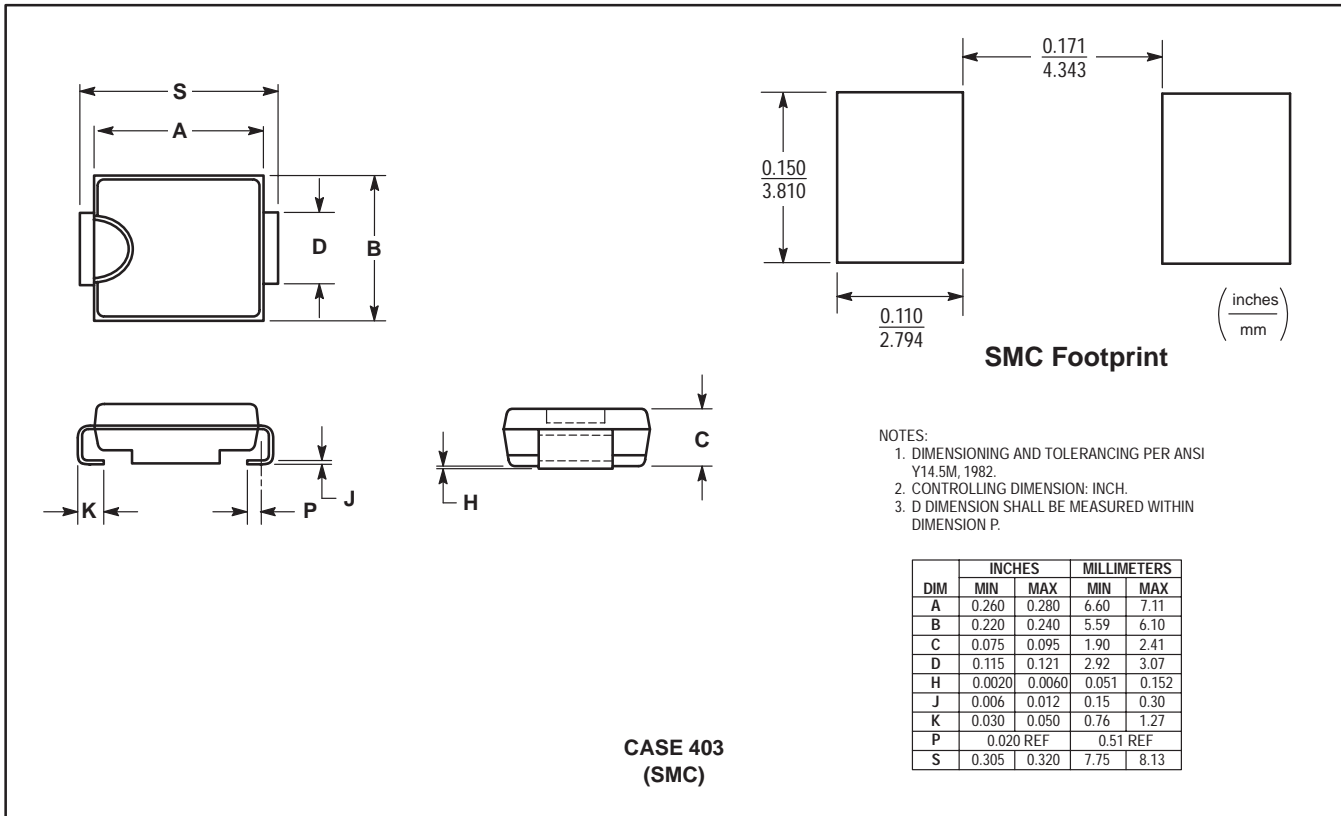
† Surge current waveform per Figure 2 and derate per Figure 3 of General Data — 1500 Watt at the beginning of this group.

†† T3 suffix designates tape and reel of 2500 units.

Devices listed in bold, italic are Motorola preferred devices.

# Transient Voltage Suppressors — Surface Mounted

## 1500 Watt Peak Power



(Refer to Section 10 for Surface Mount, Thermal Data and Footprint Information.)

### MULTIPLE PACKAGE QUANTITY (MPQ) REQUIREMENTS

Package Option	Type No. Suffix	MPQ (Units)
Tape and Reel	T3 (13 inch reel)	2.5K

(Refer to Section 10 for more information on Packaging Specifications.)

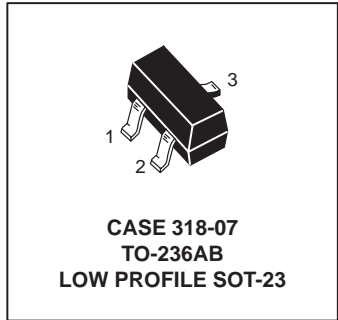
Devices listed in bold, italic are Motorola preferred devices.



# 15 Volt SOT-23 Bipolar Zener Overvoltage Transient Suppressor

**MMBZ15VDLT1**

**SOT-23 BIPOLAR  
 ZENER OVERVOLTAGE  
 TRANSIENT SUPPRESSOR  
 15 VOLT  
 40 WATTS PEAK POWER**



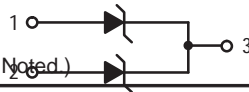
This monolithic silicon zener device is designed for applications requiring transient overvoltage protection capability. It is intended for use in voltage and ESD sensitive equipment such as computers, business machines, communication systems, medical equipment and other applications. The convenient SOT-23 package allows for easy handling and is ideal for situations where space is at a premium.

**Specification Features:**

- Dual Package Provides for Bidirectional or Separate Unidirectional Configurations
- Economical SOT-23 Surface Mount Package
- Peak Power — 40 Watts @ 1 ms (Bidirectional)
- Maximum Clamping Voltage @ Peak Pulse Current
- Low Leakage < 100 nA

**Mechanical Characteristics:**

- Case:** Void free, transfer-molded, thermosetting plastic
- Finish:** All external surfaces are corrosion resistant and leads are readily solderable
- Packaging:** Available in 8 mm embossed tape and reel (3000 devices per reel)
- Pinout:** Terminal 1 — Anode  
 Terminal 2 — Anode  
 Terminal 3 — Cathode



**MAXIMUM RATINGS** ( $T_C = 25^\circ\text{C}$  Unless Otherwise Noted.)

Rating	Symbol	Value	Unit
Peak Power Dissipation (1) @ $T_A \leq 25^\circ\text{C}$	$P_{pk}$	40	Watts
Total Power Dissipation on FR-5 Board (2) @ $T_A = 25^\circ\text{C}$ Derate above $25^\circ\text{C}$	$P_D$	225 1.8	mW mW/ $^\circ\text{C}$
Total Power Dissipation on Alumina Substrate (3) @ $T_A = 25^\circ\text{C}$ Derate above $25^\circ\text{C}$	$P_D$	300 2.4	mW mW/ $^\circ\text{C}$
Operating and Storage Temperature Range	$T_J, T_{stg}$	-55 to +150	$^\circ\text{C}$

(1) Nonrepetitive current pulse per Figure 5 and derate above  $T_A = 25^\circ\text{C}$  per Figure 6.  
 (2) FR-5 = 1.0 x 0.75 x 0.62 in.  
 (3) Alumina = 0.4 x 0.3 x 0.024 in., 99.5% alumina

**THERMAL CHARACTERISTICS**

Thermal Resistance — Junction to Ambient	$R_{\theta JA}$	556	$^\circ\text{C}/\text{W}$
Maximum Lead Temperature for Soldering Purposes (10 seconds max.)	$T_L$	230	$^\circ\text{C}$

**ELECTRICAL CHARACTERISTICS** ( $T_A = 25^\circ\text{C}$  unless otherwise noted)

**BIDIRECTIONAL** (Circuit tied to pins 1 and 2)

$V_{BR}$ (Volts)							
Min	Nom	Max					
14.3	15	15.8	1.0	12.8	100	1.9	21.2
Breakdown Voltage			@ $I_T$ mA	Working Peak Reverse Voltage	Maximum Reverse Leakage Current	Maximum Reverse Surge Current	Voltage @ $I_{RSM}^\dagger$ (Clamping Voltage)
				$V_{RWM}$ (Volts)	$I_{RWM}$ IR (nA)	$I_{RSM}^\dagger$ (Amps)	$V_{RSM}$ (Volts)

† Surge current waveform per Figure 5 and derate per Figure 6.  
 ††  $V_{BR}$  measured at pulse test current  $I_T$  at an ambient temperature of  $25^\circ\text{C}$ .

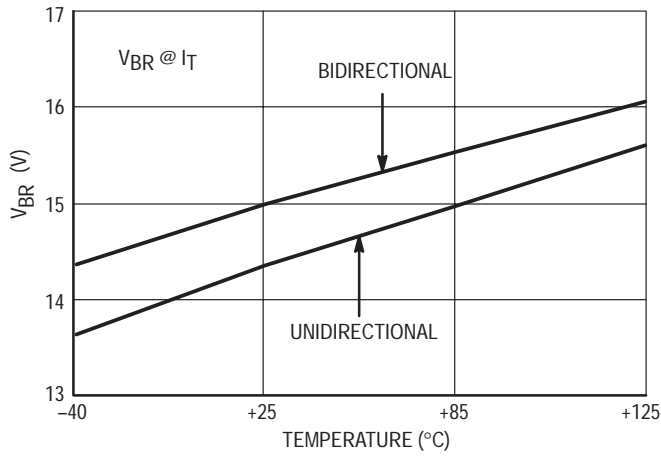


Figure 1. Typical  $V_{BR}$  versus Temperature

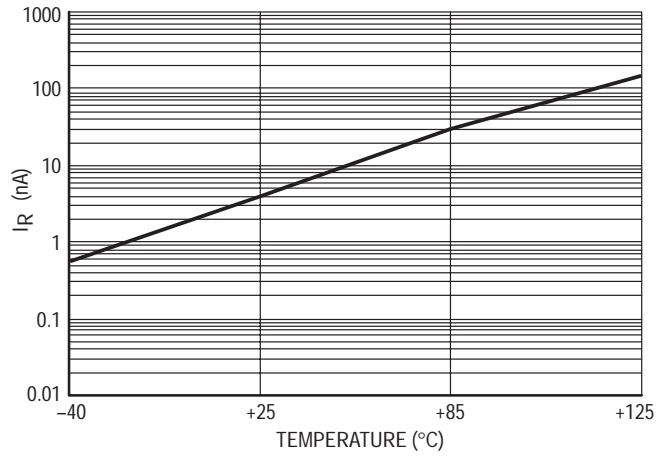


Figure 2. Typical Leakage Current versus Temperature

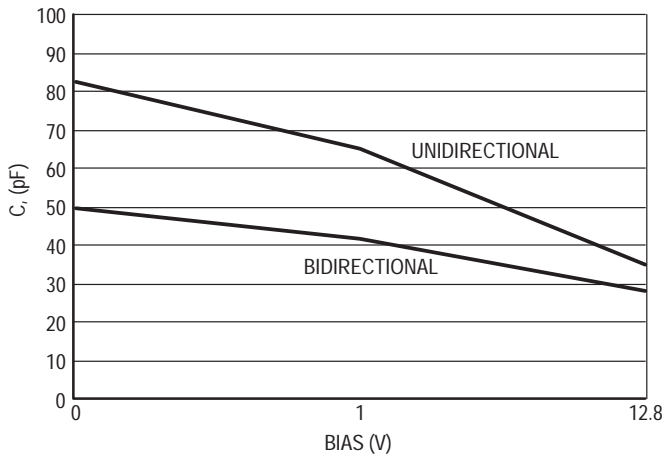


Figure 3. Typical Capacitance versus Bias Voltage

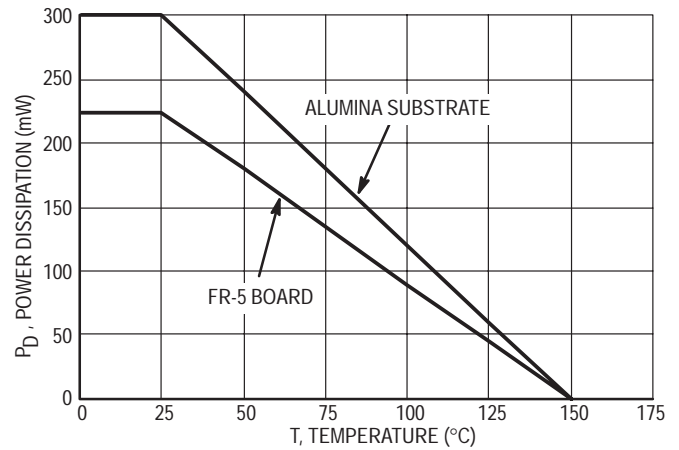


Figure 4. Steady State Power Derating Curve

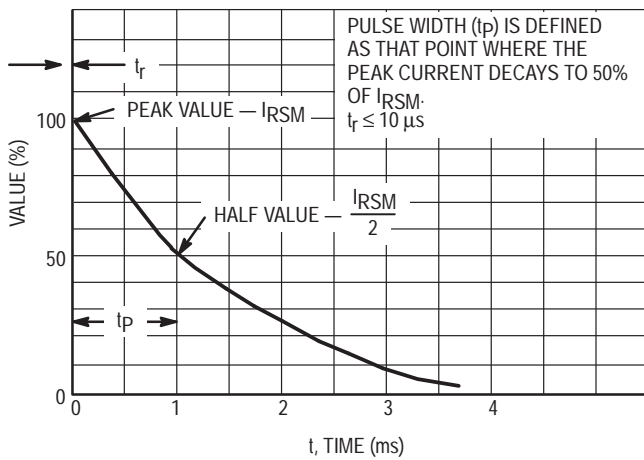


Figure 5. Pulse Waveform

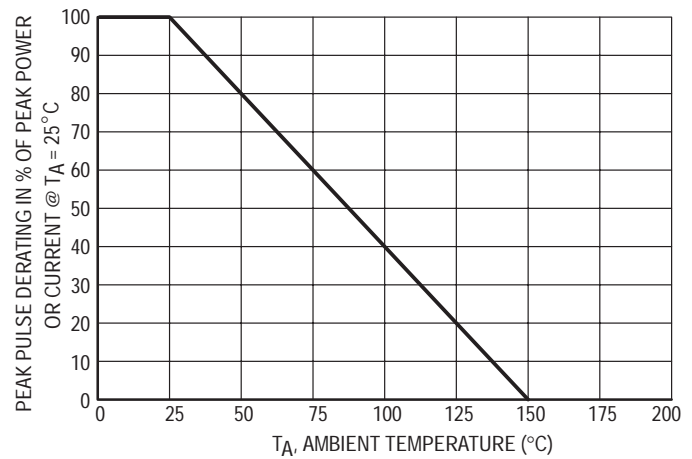
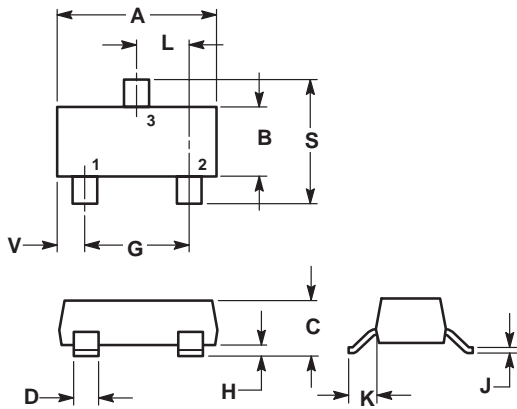


Figure 6. Pulse Derating Curve

## OUTLINE DIMENSIONS



STYLE 9:  
 PIN 1. ANODE  
 2. ANODE  
 3. CATHODE

**NOTES:**

1. DIMENSIONING AND TOLERANCING PER ANSI Y14.5M, 1982.
2. CONTROLLING DIMENSION: INCH.
3. MAXIMUM LEAD THICKNESS INCLUDES LEAD FINISH THICKNESS. MINIMUM LEAD THICKNESS IS THE MINIMUM THICKNESS OF BASE MATERIAL.
3. 318-03 OBSOLETE, NEW STANDARD 318-07.

DIM	MILLIMETERS		INCHES	
	MIN	MAX	MIN	MAX
A	2.80	3.04	0.1102	0.1197
B	1.20	1.40	0.0472	0.0551
C	0.89	1.11	0.0350	0.0440
D	0.37	0.50	0.0150	0.0200
G	1.78	2.04	0.0701	0.0807
H	0.013	0.100	0.0005	0.0040
J	0.085	0.177	0.0034	0.0070
K	0.45	0.60	0.0180	0.0236
L	0.89	1.02	0.0350	0.0401
S	2.10	2.50	0.0830	0.0984
V	0.45	0.60	0.0177	0.0236

**CASE  
 318-07  
 TO-236AB**

Motorola reserves the right to make changes without further notice to any products herein to improve reliability, function or design. Motorola does not assume any liability arising out of the application or use of any product or circuit described herein; neither does it convey any license under its patent rights nor the rights of others. Motorola products are not designed, intended, or authorized for use as components in systems intended for surgical implant into the body, or other applications intended to support or sustain life, or for any other application in which the failure of the Motorola product could create a situation where personal injury or death may occur. Should Buyer purchase or use Motorola products for any such unintended or unauthorized application, Buyer shall indemnify and hold Motorola and its officers, employees, subsidiaries, affiliates, and distributors harmless against all claims, costs, damages, and expenses, and reasonable attorney fees arising out of, directly or indirectly, any claim of personal injury or death associated with such unintended or unauthorized use, even if such claim alleges that Motorola was negligent regarding the design or manufacture of the part. Motorola and are registered trademarks of Motorola, Inc. Motorola, Inc. is an Equal Opportunity/Affirmative Action Employer.

**Literature Distribution Centers:**

USA: Motorola Literature Distribution; P.O. Box 20912; Phoenix, Arizona 85036.

EUROPE: Motorola Ltd.; European Literature Center; 88 Tanners Drive, Blakelands, Milton Keynes, MK14 5BP, England.

JAPAN: Nippon Motorola Ltd.; 4-32-1, Nishi-Gotanda, Shinagawa-ku, Tokyo 141 Japan.

ASIA-PACIFIC: Motorola Semiconductors H.K. Ltd.; Silicon Harbour Center, No. 2 Dai King Street, Tai Po Industrial Estate,  
Tai Po, N.T., Hong Kong.



MMBZ15VDLT1



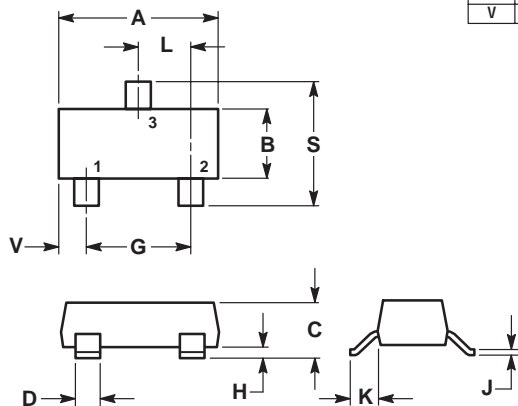
# Transient Voltage Suppressors — Surface Mounted

## 40 Watt Peak Power

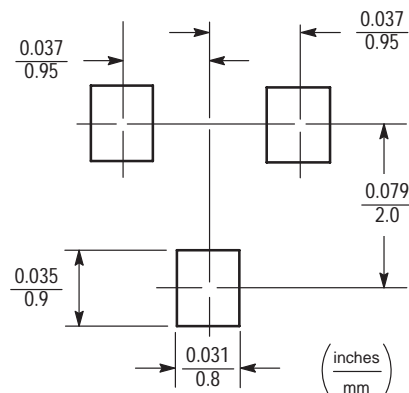
**NOTES:**

1. DIMENSIONING AND TOLERANCING PER ANSI Y14.5M, 1982.
2. CONTROLLING DIMENSION: INCH.
3. MAXIMUM LEAD THICKNESS INCLUDES LEAD FINISH THICKNESS. MINIMUM LEAD THICKNESS IS THE MINIMUM THICKNESS OF BASE MATERIAL.

DIM	INCHES		MILLIMETERS	
	MIN	MAX	MIN	MAX
A	0.1102	0.1197	2.80	3.04
B	0.0472	0.0551	1.20	1.40
C	0.0350	0.0440	0.89	1.11
D	0.0150	0.0200	0.37	0.50
G	0.0701	0.0807	1.78	2.04
H	0.0005	0.0040	0.013	0.100
J	0.0034	0.0070	0.085	0.177
K	0.0180	0.0236	0.45	0.60
L	0.0350	0.0401	0.89	1.02
S	0.0830	0.0984	2.10	2.50
V	0.0177	0.0236	0.45	0.60



STYLE 9:  
 PIN 1. ANODE  
 2. ANODE  
 3. CATHODE



**SOT-23 Footprint**

**CASE 318-07**  
**PLASTIC**

(Refer to Section 10 for Surface Mount, Thermal Data and Footprint Information.)

**MULTIPLE PACKAGE QUANTITY (MPQ) REQUIREMENTS**

Package Option	Type No. Suffix	MPQ (Units)
Tape and Reel	T1	3K
Tape and Reel	T3	10K

(Refer to Section 10 for more information on Packaging Specifications.)

## GENERAL DATA APPLICABLE TO ALL SERIES IN THIS GROUP

# Zener Transient Voltage Suppressors

The SMB series is designed to protect voltage sensitive components from high voltage, high energy transients. They have excellent clamping capability, high surge capability, low zener impedance and fast response time. The SMB series is supplied in Motorola's exclusive, cost-effective, highly reliable Surmetic package and is ideally suited for use in communication systems, numerical controls, process controls, medical equipment, business machines, power supplies and many other industrial/consumer applications.

### Specification Features:

- Standard Zener Breakdown Voltage Range — 6.8 to 200 V
- Stand-off Voltage Range — 5 to 170 V
- Peak Power — 600 Watts @ 1 ms
- Maximum Clamp Voltage @ Peak Pulse Current
- Low Leakage < 5  $\mu$ A Above 10 V
- Response Time Typically < 1 ns

### Mechanical Characteristics:

**CASE:** Void-free, transfer-molded, thermosetting plastic

**FINISH:** All external surfaces are corrosion resistant and leads are readily solderable

**POLARITY:** Cathode indicated by molded polarity notch. When operated in zener mode, will be positive with respect to anode

**MOUNTING POSITION:** Any

**LEADS:** Modified L-Bend providing more contact area to bond pad

**MAXIMUM CASE TEMPERATURE FOR SOLDERING PURPOSES:** 260°C for 10 seconds

**WAFER FAB LOCATION:** Phoenix, Arizona

**ASSEMBLY/TEST LOCATION:** Seremban, Malaysia

**GENERAL  
DATA  
600 WATT  
PEAK POWER**

**PLASTIC SURFACE MOUNT  
ZENER OVERVOLTAGE  
TRANSIENT  
SUPPRESSORS  
6.8–200 VOLTS  
600 WATT PEAK POWER**



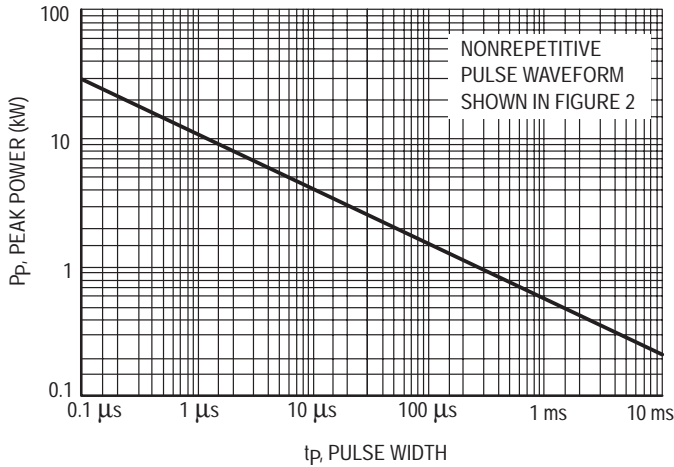
**CASE 403A  
PLASTIC**

### MAXIMUM RATINGS

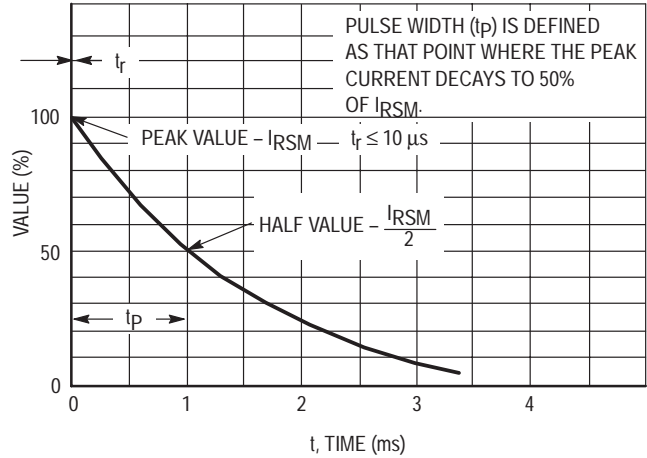
Rating	Symbol	Value	Unit
Peak Power Dissipation (1) @ $T_L \leq 25^\circ\text{C}$	PPK	600	Watts
Forward Surge Current (2) @ $T_A = 25^\circ\text{C}$	I <sub>FSM</sub>	100	Amps
Operating and Storage Temperature Range	$T_J, T_{stg}$	-65 to +150	°C

NOTES: 1. Nonrepetitive current pulse per Figure 2 and derated above  $T_A = 25^\circ\text{C}$  per Figure 3.  
2. 1/2 sine wave (or equivalent square wave), PW = 8.3 ms, duty cycle = 4 pulses per minute maximum.

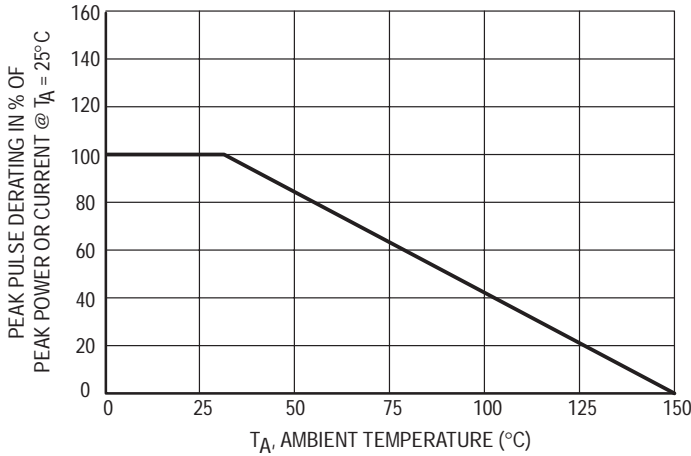
# MMBZ5V6ALT1



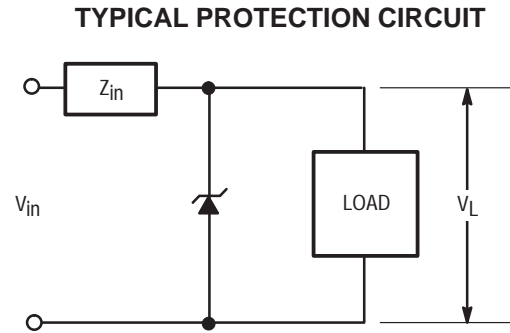
**Figure 1. Pulse Rating Curve**



**Figure 2. Pulse Waveform**



**Figure 3. Pulse Derating Curve**



## APPLICATION NOTES

### RESPONSE TIME

In most applications, the transient suppressor device is placed in parallel with the equipment or component to be protected. In this situation, there is a time delay associated with the capacitance of the device and an overshoot condition associated with the inductance of the device and the inductance of the connection method. The capacitive effect is of minor importance in the parallel protection scheme because it only produces a time delay in the transition from the operating voltage to the clamp voltage as shown in Figure 4.

The inductive effects in the device are due to actual turn-on time (time required for the device to go from zero current to full current) and lead inductance. This inductive effect produces an overshoot in the voltage across the equipment or component being protected as shown in Figure 5. Minimizing this overshoot is very important in the application, since the main purpose for adding a transient suppressor is to clamp voltage spikes. The SMB series have a very good response time, typically < 1 ns and negligible inductance. However, external inductive effects could produce unacceptable overshoot. Proper circuit layout, minimum lead lengths and placing

the suppressor device as close as possible to the equipment or components to be protected will minimize this overshoot.

Some input impedance represented by  $Z_{in}$  is essential to prevent overstress of the protection device. This impedance should be as high as possible, without restricting the circuit operation.

### DUTY CYCLE DERATING

The data of Figure 1 applies for non-repetitive conditions and at a lead temperature of 25°C. If the duty cycle increases, the peak power must be reduced as indicated by the curves of Figure 6. Average power must be derated as the lead or ambient temperature rises above 25°C. The average power derating curve normally given on data sheets may be normalized and used for this purpose.

At first glance the derating curves of Figure 6 appear to be in error as the 10 ms pulse has a higher derating factor than the 10 μs pulse. However, when the derating factor for a given pulse of Figure 6 is multiplied by the peak power value of Figure 1 for the same pulse, the results follow the expected trend.

# MMBZ5V6ALT1

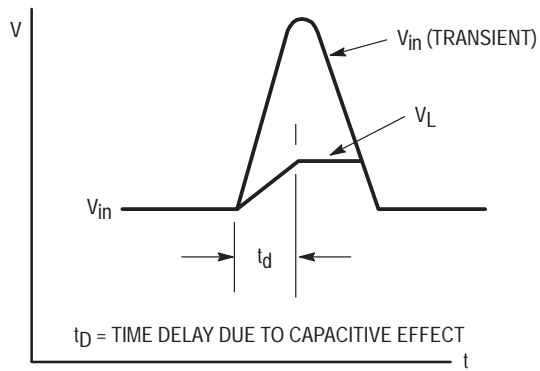


Figure 4.

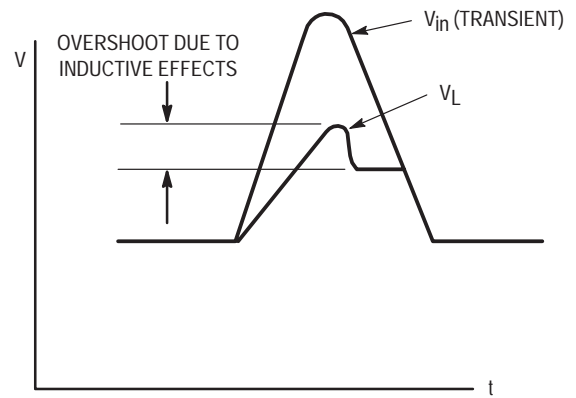


Figure 5.

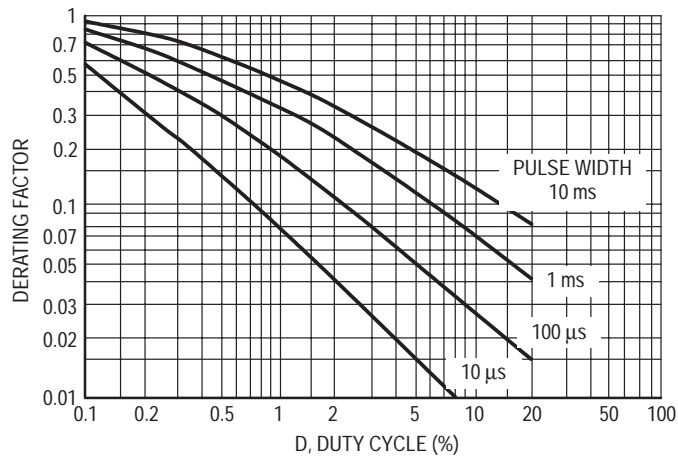


Figure 6. Typical Derating Factor for Duty Cycle



# MMBZ5V6ALT1

## ELECTRICAL CHARACTERISTICS (T<sub>A</sub> = 25°C unless otherwise noted).

Device††	Reverse Stand-Off Voltage V <sub>R</sub> Volts (1)	Breakdown Voltage*		Maximum Clamping Voltage V <sub>C</sub> @ I <sub>pp</sub> Volts	Peak Pulse Current (See Figure 2) I <sub>pp</sub> † Amps	Maximum Reverse Leakage @ V <sub>R</sub> I <sub>R</sub> μA	Device Marking
		V <sub>BR</sub> @ I <sub>T</sub> Volts Min	mA				
1SMB5.0AT3	5.0	6.40	10	9.2	65.2	800	KE
1SMB6.0AT3	6.0	6.67	10	10.3	58.3	800	KG
1SMB6.5AT3	6.5	7.22	10	11.2	53.6	500	KK
1SMB7.0AT3	7.0	7.78	10	12.0	50.0	200	KM
1SMB7.5AT3	7.5	8.33	1.0	12.9	46.5	100	KP
1SMB8.0AT3	8.0	8.89	1.0	13.6	44.1	50	KR
1SMB8.5AT3	8.5	9.44	1.0	14.4	41.7	10	KT
1SMB9.0AT3	9.0	10.0	1.0	15.4	39.0	5.0	KV
1SMB10AT3	10	11.1	1.0	17.0	35.3	5.0	KX
1SMB11AT3	11	12.2	1.0	18.2	33.0	5.0	KZ
1SMB12AT3	12	13.3	1.0	19.9	30.2	5.0	LE
1SMB13AT3	13	14.4	1.0	21.5	27.9	5.0	LG
1SMB14AT3	14	15.6	1.0	23.2	25.8	5.0	LK
1SMB15AT3	15	16.7	1.0	24.4	24.0	5.0	LM
1SMB16AT3	16	17.8	1.0	26.0	23.1	5.0	LP
1SMB17AT3	17	18.9	1.0	27.6	21.7	5.0	LR
1SMB18AT3	18	20.0	1.0	29.2	20.5	5.0	LT
1SMB20AT3	20	22.2	1.0	32.4	18.5	5.0	LV
1SMB22AT3	22	24.4	1.0	35.5	16.9	5.0	LX
1SMB24AT3	24	26.7	1.0	38.9	15.4	5.0	LZ
1SMB26AT3	26	28.9	1.0	42.1	14.2	5.0	ME
1SMB28AT3	28	31.1	1.0	45.4	13.2	5.0	MG
1SMB30AT3	30	33.3	1.0	48.4	12.4	5.0	MK
1SMB33AT3	33	36.7	1.0	53.3	11.3	5.0	MM
1SMB36AT3	36	40.0	1.0	58.1	10.3	5.0	MP
1SMB40AT3	40	44.4	1.0	64.5	9.3	5.0	MR
1SMB43AT3	43	47.8	1.0	69.4	8.6	5.0	MT
1SMB45AT3	45	50.0	1.0	72.7	8.3	5.0	MV
1SMB48AT3	48	53.3	1.0	77.4	7.7	5.0	MX
1SMB51AT3	51	56.7	1.0	82.4	7.3	5.0	MZ
1SMB54AT3	54	60.0	1.0	87.1	6.9	5.0	NE
1SMB58AT3	58	64.4	1.0	93.6	6.4	5.0	NG
1SMB60AT3	60	66.7	1.0	96.8	6.2	5.0	NK
1SMB64AT3	64	71.1	1.0	103	5.8	5.0	NM
1SMB70AT3	70	77.8	1.0	113	5.3	5.0	NP
1SMB75AT3	75	83.3	1.0	121	4.9	5.0	NR
1SMB78AT3	78	86.7	1.0	126	4.7	5.0	NT
1SMB85AT3	85	94.4	1.0	137	4.4	5.0	NV
1SMB90AT3	90	100	1.0	146	4.1	5.0	NX
1SMB100AT3	100	111	1.0	162	3.7	5.0	NZ
1SMB110AT3	110	122	1.0	177	3.4	5.0	PE
1SMB120AT3	120	133	1.0	193	3.1	5.0	PG
1SMB130AT3	130	144	1.0	209	2.9	5.0	PK
1SMB150AT3	150	167	1.0	243	2.5	5.0	PM
1SMB160AT3	160	178	1.0	259	2.3	5.0	PP
1SMB170AT3	170	189	1.0	275	2.2	5.0	PR

Note 1: A transient suppressor is normally selected according to the reverse "Stand Off Voltage" (V<sub>R</sub>) which should be equal to or greater than the DC or continuous peak operating voltage level.

\* V<sub>BR</sub> measured at pulse test current I<sub>T</sub> at an ambient temperature of 25°C.

† Surge current waveform per Figure 2 and derate per Figure 3 of the General Data — 600 Watt at the beginning of this group.

†† T3 suffix designates tape and reel of 2500 units.

### ABBREVIATIONS AND SYMBOLS

**V<sub>R</sub>** Stand Off Voltage. Applied reverse voltage to assure a non-conductive condition (See Note 1).

**V<sub>(BR)min</sub>** This is the minimum breakdown voltage the device will exhibit and is used to assure that conduction does not occur prior to this voltage level at 25°C.

**V<sub>C</sub>** Maximum Clamping Voltage. The maximum peak voltage appearing across the transient suppressor when

subjected to the peak pulse current in a one millisecond time interval. The peak pulse voltages are the combination of voltage rise due to both the series resistance and thermal rise.

**I<sub>pp</sub>** Peak Pulse Current — See Figure 2

**P<sub>p</sub>** Peak Pulse Power

**I<sub>R</sub>** Reverse Leakage

# MMBZ5V6ALT1

## ELECTRICAL CHARACTERISTICS (T<sub>A</sub> = 25°C unless otherwise noted).

Device††	Reverse Stand-Off Voltage V <sub>R</sub> Volts (1)	Breakdown Voltage*		Maximum Clamping Voltage V <sub>C</sub> @ I <sub>pp</sub> Volts	Peak Pulse Current (See Figure 2) I <sub>pp</sub> † Amps	Maximum Reverse Leakage @ V <sub>R</sub> I <sub>R</sub> μA	Device Marking
		V <sub>BR</sub> @ I <sub>T</sub> Volts Min	mA				
1SMB10CAT3	10	11.1	1.0	17.0	35.3	5.0	KXC
1SMB11CAT3	11	12.2	1.0	18.2	33.0	5.0	KZC
1SMB12CAT3	12	13.3	1.0	19.9	30.2	5.0	LEC
1SMB13CAT3	13	14.4	1.0	21.5	27.9	5.0	LGC
1SMB14CAT3	14	15.6	1.0	23.2	25.8	5.0	LKC
<b>1SMB15CAT3</b>	<b>15</b>	<b>16.7</b>	<b>1.0</b>	<b>24.4</b>	<b>24.0</b>	<b>5.0</b>	<b>LMC</b>
1SMB16CAT3	16	17.8	1.0	26.0	23.1	5.0	LPC
1SMB17CAT3	17	18.9	1.0	27.6	21.7	5.0	LRC
1SMB18CAT3	18	20.0	1.0	29.2	20.5	5.0	LTC
1SMB20CAT3	20	22.2	1.0	32.4	18.5	5.0	LVC
1SMB22CAT3	22	24.4	1.0	35.5	16.9	5.0	LXC
1SMB24CAT3	24	26.7	1.0	38.9	15.4	5.0	LZC
1SMB26CAT3	26	28.9	1.0	42.1	14.2	5.0	MEC
1SMB28CAT3	28	31.1	1.0	45.4	13.2	5.0	MGC
1SMB30CAT3	30	33.3	1.0	48.4	12.4	5.0	MKC
1SMB33CAT3	33	36.7	1.0	53.3	11.3	5.0	MMC
1SMB36CAT3	36	40.0	1.0	58.1	10.3	5.0	MPC
1SMB40CAT3	40	44.4	1.0	64.5	9.3	5.0	MRC
1SMB43CAT3	43	47.8	1.0	69.4	8.6	5.0	MTC
1SMB45CAT3	45	50.0	1.0	72.7	8.3	5.0	MVC
1SMB48CAT3	48	53.3	1.0	77.4	7.7	5.0	MXC
1SMB51CAT3	51	56.7	1.0	82.4	7.3	5.0	MZC
1SMB54CAT3	54	60.0	1.0	87.1	6.9	5.0	NEC
1SMB58CAT3	58	64.4	1.0	93.6	6.4	5.0	NGC
1SMB60CAT3	60	66.7	1.0	96.8	6.2	5.0	NKC
1SMB64CAT3	64	71.1	1.0	103	5.8	5.0	NMC
1SMB70CAT3	70	77.8	1.0	113	5.3	5.0	NPC
1SMB75CAT3	75	83.3	1.0	121	4.9	5.0	NRC
1SMB78CAT3	78	86.7	1.0	126	4.7	5.0	NTC

Note 1: A transient suppressor is normally selected according to the reverse "Stand Off Voltage" (V<sub>R</sub>) which should be equal to or greater than the DC or continuous peak operating voltage level.

\* V<sub>BR</sub> measured at pulse test current I<sub>T</sub> at an ambient temperature of 25°C.

† Surge current waveform per Figure 2 and derate per Figure 3 of the General Data — 600 Watt at the beginning of this group.

†† T3 suffix designates tape and reel of 2500 units.

### ABBREVIATIONS AND SYMBOLS

**V<sub>R</sub>** Stand Off Voltage. Applied reverse voltage to assure a non-conductive condition (See Note 1).

**V(BR)min** This is the minimum breakdown voltage the device will exhibit and is used to assure that conduction does not occur prior to this voltage level at 25°C.

**V<sub>C</sub>** Maximum Clamping Voltage. The maximum peak voltage appearing across the transient suppressor when

**I<sub>pp</sub>**  
**P<sub>p</sub>**  
**I<sub>R</sub>**

subjected to the peak pulse current in a one millisecond time interval. The peak pulse voltages are the combination of voltage rise due to both the series resistance and thermal rise.

Peak Pulse Current — See Figure 2

Peak Pulse Power

Reverse Leakage

# MMBZ5V6ALT1

ELECTRICAL CHARACTERISTICS ( $T_A = 25^\circ\text{C}$  unless otherwise noted)  $V_F = 3.5\text{ V Max}$ ,  $I_F^{**} = 50\text{ A}$  for all types.

Device††	Breakdown Voltage*				Working Peak Reverse Voltage $V_{RWM}$ Volts	Maximum Reverse Leakage @ $V_{RWM}$ $I_R$ $\mu\text{A}$	Maximum Reverse Surge Current $I_{RSM}^\dagger$ Amps	Maximum Reverse Voltage @ $I_{RSM}$ (Clamping Voltage) $V_{RSM}$ Volts	Maximum Temperature Coefficient of $V_{BR}$ $\%/^\circ\text{C}$	Device Marking
	$V_{BR}$ @ $I_T$ Volts									
	Min	Nom	Max	mA						
<b>P6SMB6.8AT3</b>	<b>6.45</b>	<b>6.8</b>	<b>7.14</b>	<b>10</b>	<b>5.8</b>	<b>1000</b>	<b>57</b>	<b>10.5</b>	<b>0.057</b>	<b>6V8A</b>
<b>P6SMB7.5AT3</b>	<b>7.13</b>	<b>7.5</b>	<b>7.88</b>	<b>10</b>	<b>6.4</b>	<b>500</b>	<b>53</b>	<b>11.3</b>	<b>0.061</b>	<b>7V5A</b>
P6SMB8.2AT3	7.79	8.2	8.61	10	7.02	200	50	12.1	0.065	8V2A
P6SMB9.1AT3	8.65	9.1	9.55	1	7.78	50	45	13.4	0.068	9V1A
<b>P6SMB10AT3</b>	<b>9.5</b>	<b>10</b>	<b>10.5</b>	<b>1</b>	<b>8.55</b>	<b>10</b>	<b>41</b>	<b>14.5</b>	<b>0.073</b>	<b>10A</b>
P6SMB11AT3	10.5	11	11.6	1	9.4	5	38	15.6	0.075	11A
P6SMB12AT3	11.4	12	12.6	1	10.2	5	36	16.7	0.078	12A
<b>P6SMB13AT3</b>	<b>12.4</b>	<b>13</b>	<b>13.7</b>	<b>1</b>	<b>11.1</b>	<b>5</b>	<b>33</b>	<b>18.2</b>	<b>0.081</b>	<b>13A</b>
<b>P6SMB15AT3</b>	<b>14.3</b>	<b>15</b>	<b>15.8</b>	<b>1</b>	<b>12.8</b>	<b>5</b>	<b>28</b>	<b>21.2</b>	<b>0.084</b>	<b>15A</b>
<b>P6SMB16AT3</b>	<b>15.2</b>	<b>16</b>	<b>16.8</b>	<b>1</b>	<b>13.6</b>	<b>5</b>	<b>27</b>	<b>22.5</b>	<b>0.086</b>	<b>16A</b>
<b>P6SMB18AT3</b>	<b>17.1</b>	<b>18</b>	<b>18.9</b>	<b>1</b>	<b>15.3</b>	<b>5</b>	<b>24</b>	<b>25.2</b>	<b>0.088</b>	<b>18A</b>
<b>P6SMB20AT3</b>	<b>19</b>	<b>20</b>	<b>21</b>	<b>1</b>	<b>17.1</b>	<b>5</b>	<b>22</b>	<b>27.7</b>	<b>0.09</b>	<b>20A</b>
<b>P6SMB22AT3</b>	<b>20.9</b>	<b>22</b>	<b>23.1</b>	<b>1</b>	<b>18.8</b>	<b>5</b>	<b>20</b>	<b>30.6</b>	<b>0.092</b>	<b>22A</b>
P6SMB24AT3	22.8	24	25.2	1	20.5	5	18	33.2	0.094	24A
<b>P6SMB27AT3</b>	<b>25.7</b>	<b>27</b>	<b>28.4</b>	<b>1</b>	<b>23.1</b>	<b>5</b>	<b>16</b>	<b>37.5</b>	<b>0.096</b>	<b>27A</b>
<b>P6SMB30AT3</b>	<b>28.5</b>	<b>30</b>	<b>31.5</b>	<b>1</b>	<b>25.6</b>	<b>5</b>	<b>14.4</b>	<b>41.4</b>	<b>0.097</b>	<b>30A</b>
P6SMB33AT3	31.4	33	34.7	1	28.2	5	13.2	45.7	0.098	33A
<b>P6SMB36AT3</b>	<b>34.2</b>	<b>36</b>	<b>37.8</b>	<b>1</b>	<b>30.8</b>	<b>5</b>	<b>12</b>	<b>49.9</b>	<b>0.099</b>	<b>36A</b>
<b>P6SMB39AT3</b>	<b>37.1</b>	<b>39</b>	<b>41</b>	<b>1</b>	<b>33.3</b>	<b>5</b>	<b>11.2</b>	<b>53.9</b>	<b>0.1</b>	<b>39A</b>
P6SMB43AT3	40.9	43	45.2	1	36.8	5	10.1	59.3	0.101	43A
P6SMB47AT3	44.7	47	49.4	1	40.2	5	9.3	64.8	0.101	47A
<b>P6SMB51AT3</b>	<b>48.5</b>	<b>51</b>	<b>53.6</b>	<b>1</b>	<b>43.6</b>	<b>5</b>	<b>8.6</b>	<b>70.1</b>	<b>0.102</b>	<b>51A</b>
P6SMB56AT3	53.2	56	58.8	1	47.8	5	7.8	77	0.103	56A
P6SMB62AT3	58.9	62	65.1	1	53	5	7.1	85	0.104	62A
P6SMB68AT3	64.6	68	71.4	1	58.1	5	6.5	92	0.104	68A
P6SMB75AT3	71.3	75	78.8	1	64.1	5	5.8	103	0.105	75A
P6SMB82AT3	77.9	82	86.1	1	70.1	5	5.3	113	0.105	82A
P6SMB91AT3	86.5	91	95.5	1	77.8	5	4.8	125	0.106	91A
P6SMB100AT3	95	100	105	1	85.5	5	4.4	137	0.106	100A
P6SMB110AT3	105	110	116	1	94	5	4	152	0.107	110A
P6SMB120AT3	114	120	126	1	102	5	3.6	165	0.107	120A
P6SMB130AT3	124	130	137	1	111	5	3.3	179	0.107	130A
P6SMB150AT3	143	150	158	1	128	5	2.9	207	0.108	150A
<b>P6SMB160AT3</b>	<b>152</b>	<b>160</b>	<b>168</b>	<b>1</b>	<b>136</b>	<b>5</b>	<b>2.7</b>	<b>219</b>	<b>0.108</b>	<b>160A</b>
P6SMB170AT3	162	170	179	1	145	5	2.6	234	0.108	170A
P6SMB180AT3	171	180	189	1	154	5	2.4	246	0.108	180A
P6SMB200AT3	190	200	210	1	171	5	2.2	274	0.108	200A

\*  $V_{BR}$  measured at pulse test current  $I_T$  at an ambient temperature of  $25^\circ\text{C}$ .

\*\* 1/2 sine wave (or equivalent square wave),  $PW = 8.3\text{ ms}$ , duty cycle = 4 pulses per minute maximum.

† Surge current waveform per Figure 2 and derate per Figure 3 of the General Data — 600 Watt at the beginning of this group.

†† T3 suffix designates tape and reel of 2500 units.

# MMBZ5V6ALT1

**ELECTRICAL CHARACTERISTICS** ( $T_A = 25^\circ\text{C}$  unless otherwise noted)  $V_F = 3.5\text{ V Max}$ ,  $I_F^{**} = 50\text{ A}$  for all types.

Device††	Breakdown Voltage*				Working Peak Reverse Voltage $V_{RWM}$ Volts	Maximum Reverse Leakage @ $V_{RWM}$ $I_R$ $\mu\text{A}$	Maximum Reverse Surge Current $I_{RSM}^\dagger$ Amps	Maximum Reverse Voltage @ $f_{RSM}$ (Clamping Voltage) $V_{RSM}$ Volts	Maximum Temperature Coefficient of $V_{BR}$ $\%/^\circ\text{C}$	Device Marking
	$V_{BR}$ @ $I_T$ Volts									
	Min	Nom	Max	mA						
P6SMB11CAT3	10.5	11	11.6	1	9.4	5	38	15.6	0.075	11C
P6SMB12CAT3	11.4	12	12.6	1	10.2	5	36	16.7	0.078	12C
P6SMB13CAT3	12.4	13	13.7	1	11.1	5	33	18.2	0.081	13C
P6SMB15CAT3	14.3	15	15.8	1	12.8	5	28	21.2	0.084	15C
P6SMB16CAT3	15.2	16	16.8	1	13.6	5	27	22.5	0.086	16C
P6SMB18CAT3	17.1	18	18.9	1	15.3	5	24	25.2	0.088	18C
P6SMB20CAT3	19	20	21	1	17.1	5	22	27.7	0.09	20C
P6SMB22CAT3	20.9	22	23.1	1	18.8	5	20	30.6	0.092	22C
P6SMB24CAT3	22.8	24	25.2	1	20.5	5	18	33.2	0.094	24C
P6SMB27CAT3	25.7	27	28.4	1	23.1	5	16	37.5	0.096	27C
P6SMB30CAT3	28.5	30	31.5	1	25.6	5	14.4	41.4	0.097	30C
<b>P6SMB33CAT3</b>	<b>31.4</b>	<b>33</b>	<b>34.7</b>	<b>1</b>	<b>28.2</b>	<b>5</b>	<b>13.2</b>	<b>45.7</b>	<b>0.098</b>	<b>33C</b>
P6SMB36CAT3	34.2	36	37.8	1	30.8	5	12	49.9	0.099	36C
P6SMB39CAT3	37.1	39	41	1	33.3	5	11.2	53.9	0.1	39C
P6SMB43CAT3	40.9	43	45.2	1	36.8	5	10.1	59.3	0.101	43C
P6SMB47CAT3	44.7	47	49.4	1	40.2	5	9.3	64.8	0.101	47C
P6SMB51CAT3	48.5	51	53.6	1	43.6	5	8.6	70.1	0.102	51C
P6SMB56CAT3	53.2	56	58.8	1	47.8	5	7.8	77	0.103	56C
P6SMB62CAT3	58.9	62	65.1	1	53	5	7.1	85	0.104	62C
P6SMB68CAT3	64.6	68	71.4	1	58.1	5	6.5	92	0.104	68C
P6SMB75CAT3	71.3	75	78.8	1	64.1	5	5.8	103	0.105	75C
P6SMB82CAT3	77.9	82	86.1	1	70.1	5	5.3	113	0.105	82C
P6SMB91CAT3	86.5	91	95.5	1	77.8	5	4.8	125	0.106	91C

\*  $V_{BR}$  measured at pulse test current  $I_T$  at an ambient temperature of  $25^\circ\text{C}$ .

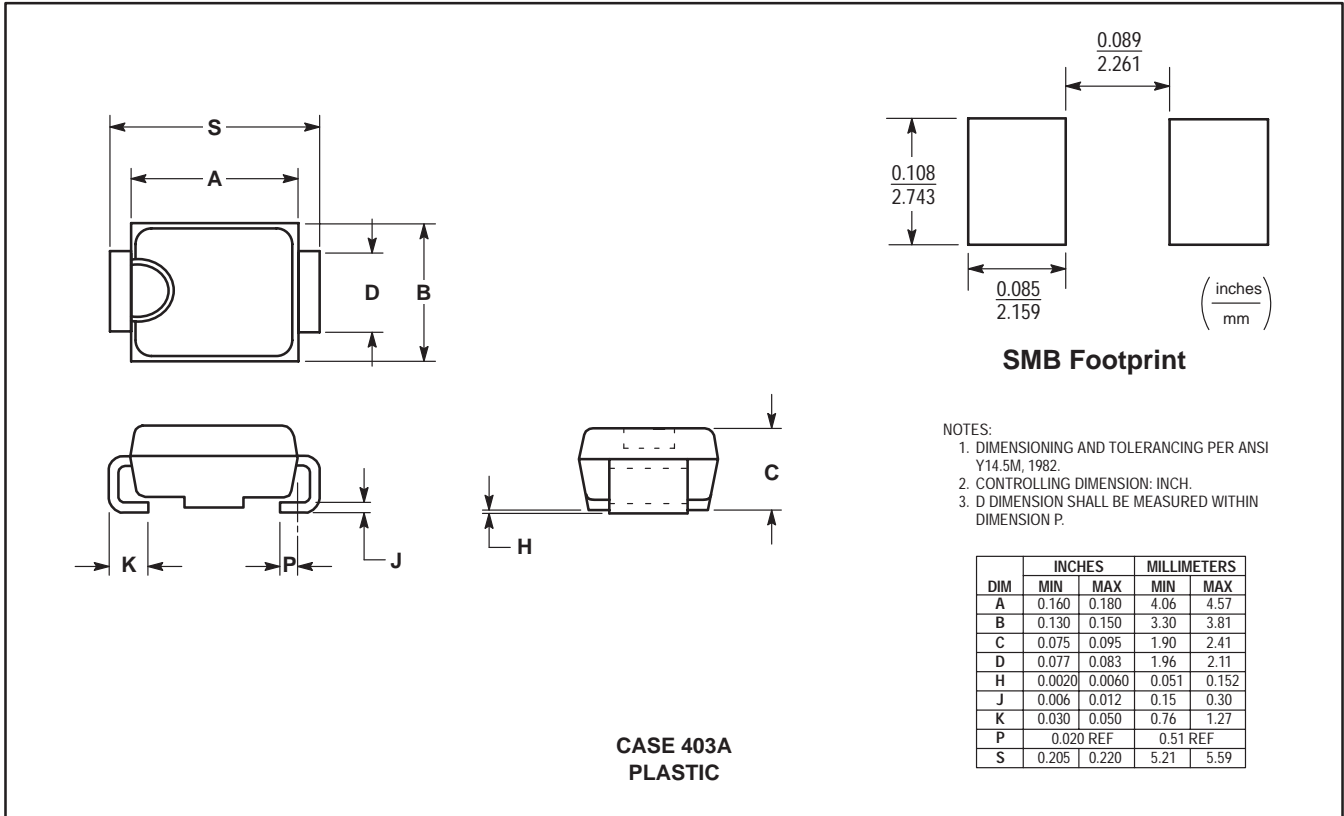
\*\* 1/2 sine wave (or equivalent square wave),  $PW = 8.3\text{ ms}$ , duty cycle = 4 pulses per minute maximum.

† Surge current waveform per Figure 2 and derate per Figure 3 of the General Data — 600 Watt at the beginning of this group.

†† T3 suffix designates tape and reel of 2500 units.

# Transient Voltage Suppressors — Surface Mounted

## 600 Watt Peak Power



(Refer to Section 10 for Surface Mount, Thermal Data and Footprint Information.)

### MULTIPLE PACKAGE QUANTITY (MPQ) REQUIREMENTS

Package Option	Type No. Suffix	MPQ (Units)
Tape and Reel	T3 (13 inch reel)	2.5K

(Refer to Section 10 for more information on Packaging Specifications.)

# MMBZ5V6ALT1

## GENERAL DATA APPLICABLE TO ALL SERIES IN THIS GROUP

### Zener Transient Voltage Suppressors

The SMC series is designed to protect voltage sensitive components from high voltage, high energy transients. They have excellent clamping capability, high surge capability, low zener impedance and fast response time. The SMC series is supplied in Motorola's exclusive, cost-effective, highly reliable Surmetic package and is ideally suited for use in communication systems, numerical controls, process controls, medical equipment, business machines, power supplies and many other industrial/consumer applications.

#### Specification Features:

- Standard Zener Breakdown Voltage Range — 6.8 to 91 V
- Stand-off Voltage Range — 5 to 78 V
- Peak Power — 1500 Watts @ 1 ms
- Maximum Clamp Voltage @ Peak Pulse Current
- Low Leakage < 5  $\mu$ A Above 10 V
- Maximum Temperature Coefficient Specified
- Available in Tape and Reel
- Response Time Typically < 1 ns

#### Mechanical Characteristics:

**CASE:** Void-free, transfer-molded, thermosetting plastic

**FINISH:** All external surfaces are corrosion resistant and leads are readily solderable

**POLARITY:** Cathode indicated by molded polarity notch. When operated in zener mode, will be positive with respect to anode

**MOUNTING POSITION:** Any

**LEADS:** Modified L-Bend providing more contact area to bond pads

**MAXIMUM CASE TEMPERATURE FOR SOLDERING PURPOSES:** 260°C for 10 seconds

**WAFER FAB LOCATION:** Phoenix, Arizona

**ASSEMBLY/TEST LOCATION:** Seremban, Malaysia

#### MAXIMUM RATINGS

Rating	Symbol	Value	Unit
Peak Power Dissipation (1) @ $T_L \leq 25^\circ\text{C}$	PPK	1500	Watts
Forward Surge Current (2) @ $T_A = 25^\circ\text{C}$	I <sub>FSM</sub>	200	Amps
Operating and Storage Temperature Range	T <sub>J</sub> , T <sub>stg</sub>	- 65 to +150	°C

NOTES: 1. Nonrepetitive current pulse per Figure 2 and derated above  $T_A = 25^\circ\text{C}$  per Figure 3.

2. 1/2 sine wave (or equivalent square wave), PW = 8.3 ms, duty cycle = 4 pulses per minute maximum.

**GENERAL  
DATA  
1500 WATT  
PEAK POWER**

**PLASTIC SURFACE MOUNT  
ZENER OVERVOLTAGE  
TRANSIENT  
SUPPRESSORS  
6.8-91 VOLTS  
1500 WATT PEAK POWER**



**CASE 403  
PLASTIC**

# MMBZ5V6ALT1

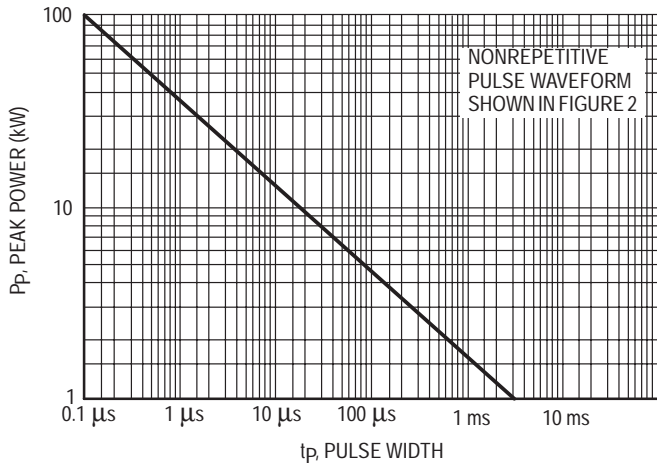


Figure 1. Pulse Rating Curve

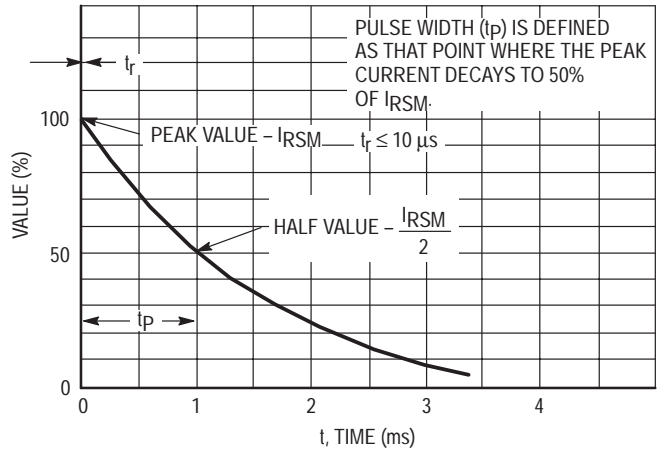


Figure 2. Pulse Waveform

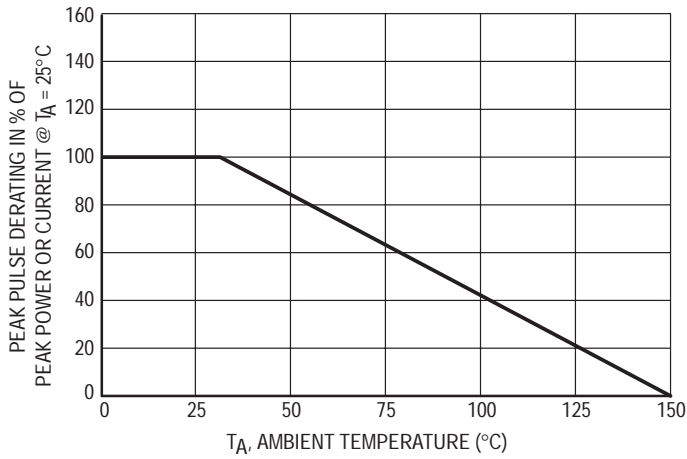


Figure 3. Pulse Derating Curve

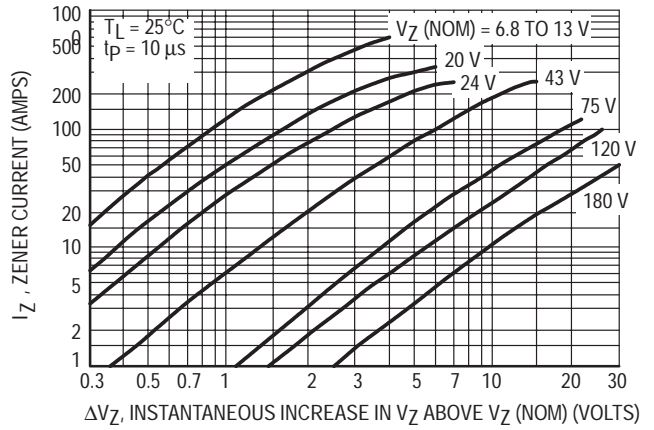


Figure 4. Dynamic Impedance

# MMBZ5V6ALT1

## APPLICATION NOTES

### RESPONSE TIME

In most applications, the transient suppressor device is placed in parallel with the equipment or component to be protected. In this situation, there is a time delay associated with the capacitance of the device and an overshoot condition associated with the inductance of the device and the inductance of the connection method. The capacitive effect is of minor importance in the parallel protection scheme because it only produces a time delay in the transition from the operating voltage to the clamp voltage as shown in Figure 5.

The inductive effects in the device are due to actual turn-on time (time required for the device to go from zero current to full current) and lead inductance. This inductive effect produces an overshoot in the voltage across the equipment or component being protected as shown in Figure 6. Minimizing this overshoot is very important in the application, since the main purpose for adding a transient suppressor is to clamp voltage spikes. The SMC series have a very good response time, typically  $< 1$  ns and negligible inductance. However, external inductive effects could produce unacceptable overshoot. Proper circuit layout, minimum lead lengths and placing the

suppressor device as close as possible to the equipment or components to be protected will minimize this overshoot.

Some input impedance represented by  $Z_{in}$  is essential to prevent overstress of the protection device. This impedance should be as high as possible, without restricting the circuit operation.

### DUTY CYCLE DERATING

The data of Figure 1 applies for non-repetitive conditions and at a lead temperature of  $25^{\circ}\text{C}$ . If the duty cycle increases, the peak power must be reduced as indicated by the curves of Figure 7. Average power must be derated as the lead or ambient temperature rises above  $25^{\circ}\text{C}$ . The average power derating curve normally given on data sheets may be normalized and used for this purpose.

At first glance the derating curves of Figure 7 appear to be in error as the 10 ms pulse has a higher derating factor than the 10  $\mu\text{s}$  pulse. However, when the derating factor for a given pulse of Figure 7 is multiplied by the peak power value of Figure 1 for the same pulse, the results follow the expected trend.

### TYPICAL PROTECTION CIRCUIT

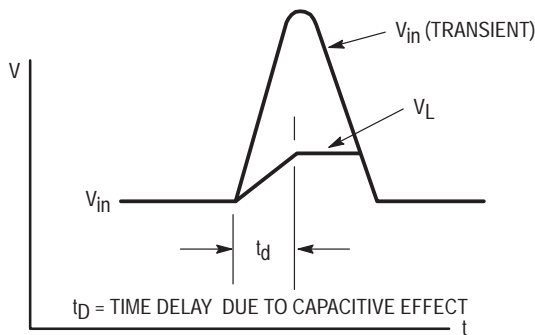
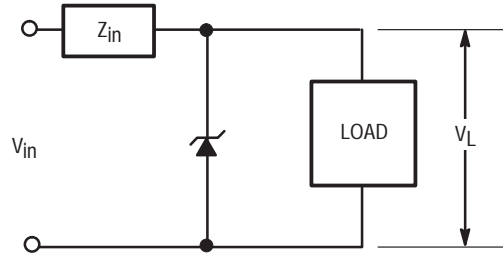


Figure 5.

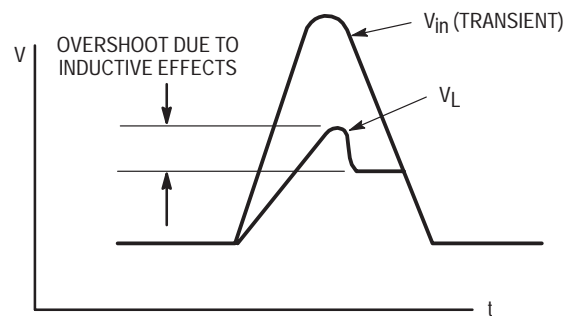


Figure 6.

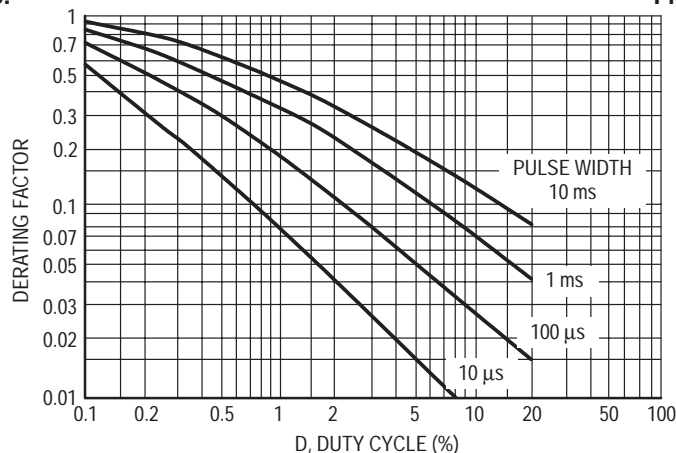


Figure 7. Typical Derating Factor for Duty Cycle



# MMBZ5V6ALT1

## ELECTRICAL CHARACTERISTICS (T<sub>A</sub> = 25°C unless otherwise noted).

Device††	Reverse Stand-Off Voltage V <sub>R</sub> Volts (1)	Breakdown Voltage* V <sub>BR</sub> @ I <sub>T</sub>		Maximum Clamping Voltage V <sub>C</sub> @ I <sub>pp</sub> Volts	Peak Pulse Current (See Figure 2) I <sub>pp</sub> † Amps	Maximum Reverse Leakage @ V <sub>R</sub> I <sub>R</sub> μA	Device Marking
		Volts Min	mA				
1SMC5.0AT3	5.0	6.40	10	9.2	163.0	1000	GDE
1SMC6.0AT3	6.0	6.67	10	10.3	145.6	1000	GDG
1SMC6.5AT3	6.5	7.22	10	11.2	133.9	500	GDK
1SMC7.0AT3	7.0	7.78	10	12.0	125.0	200	GDM
1SMC7.5AT3	7.5	8.33	1.0	12.9	116.3	100	GDP
1SMC8.0AT3	8.0	8.89	1.0	13.6	110.3	50	GDR
1SMC8.5AT3	8.5	9.44	1.0	14.4	104.2	20	GDT
1SMC9.0AT3	9.0	10.0	1.0	15.4	97.4	10	GDV
1SMC10AT3	10	11.1	1.0	17.0	88.2	5.0	GDX
1SMC11AT3	11	12.2	1.0	18.2	82.4	5.0	GDZ
1SMC12AT3	12	13.3	1.0	19.9	75.3	5.0	GEE
1SMC13AT3	13	14.4	1.0	21.5	69.7	5.0	GEG
1SMC14AT3	14	15.6	1.0	23.2	64.7	5.0	GEK
1SMC15AT3	15	16.7	1.0	24.4	61.5	5.0	GEM
1SMC16AT3	16	17.8	1.0	26.0	57.7	5.0	GEP
1SMC17AT3	17	18.9	1.0	27.6	53.3	5.0	GER
1SMC18AT3	18	20.0	1.0	29.2	51.4	5.0	GET
1SMC20AT3	20	22.2	1.0	32.4	46.3	5.0	GEV
1SMC22AT3	22	24.4	1.0	35.5	42.2	5.0	GEX
1SMC24AT3	24	26.7	1.0	38.9	38.6	5.0	GEZ
1SMC26AT3	26	28.9	1.0	42.1	35.6	5.0	GFE
1SMC28AT3	28	31.1	1.0	45.4	33.0	5.0	GFG
1SMC30AT3	30	33.3	1.0	48.4	31.0	5.0	GFK
1SMC33AT3	33	36.7	1.0	53.3	28.1	5.0	GFM
1SMC36AT3	36	40.0	1.0	58.1	25.8	5.0	GFP
1SMC40AT3	40	44.4	1.0	64.5	23.2	5.0	GFR
1SMC43AT3	43	47.8	1.0	69.4	21.6	5.0	GFT
1SMC45AT3	45	50.0	1.0	72.7	20.6	5.0	GFV
1SMC48AT3	48	53.3	1.0	77.4	19.4	5.0	GFX
1SMC51AT3	51	56.7	1.0	82.4	18.2	5.0	GFZ
1SMC54AT3	54	60.0	1.0	87.1	17.2	5.0	GGE
<b>1SMC58AT3</b>	<b>58</b>	<b>64.4</b>	<b>1.0</b>	<b>93.6</b>	<b>16.0</b>	<b>5.0</b>	<b>GGG</b>
1SMC60AT3	60	66.7	1.0	96.8	15.5	5.0	GGK
1SMC64AT3	64	71.1	1.0	103	14.6	5.0	GGM
1SMC70AT3	70	77.8	1.0	113	13.3	5.0	GGP
1SMC75AT3	75	83.3	1.0	121	12.4	5.0	GGR
1SMC78AT3	78	86.7	1.0	126	11.4	5.0	GGT

Note 1: A transient suppressor is normally selected according to the reverse "Stand Off Voltage" (V<sub>R</sub>) which should be equal to or greater than the DC or continuous peak operating voltage level.

\* V<sub>BR</sub> measured at pulse test current I<sub>T</sub> at an ambient temperature of 25°C.

† Surge current waveform per Figure 2 and derate per Figure 3 of the General Data — 1500 Watt at the beginning of this group.

†† T3 suffix designates tape and reel of 2500 units.

### ABBREVIATIONS AND SYMBOLS

**V<sub>R</sub>** Stand Off Voltage. Applied reverse voltage to assure a non-conductive condition (See Note 1).

**V<sub>(BR)min</sub>** This is the minimum breakdown voltage the device will exhibit and is used to assure that conduction does not occur prior to this voltage level at 25°C.

**V<sub>C</sub>** Maximum Clamping Voltage. The maximum peak voltage appearing across the transient suppressor when

subjected to the peak pulse current in a one millisecond time interval. The peak pulse series resistance and thermal rise.

**I<sub>pp</sub>** Peak Pulse Current — See Figure 2

**P<sub>p</sub>** Peak Pulse Power

**I<sub>R</sub>** Reverse Leakage

# MMBZ5V6ALT1

**ELECTRICAL CHARACTERISTICS** ( $T_A = 25^\circ\text{C}$  unless otherwise noted)  $V_F = 3.5\text{ V Max}$ ,  $I_F^{**} = 100\text{ A}$  for all types.

Device††	Breakdown Voltage*				Working Peak Reverse Voltage $V_{RWM}$ Volts	Maximum Reverse Leakage @ $V_{RWM}$ $I_R$ $\mu\text{A}$	Maximum Reverse Surge Current $I_{RSM}^\dagger$ Amps	Maximum Reverse Voltage @ $I_{RSM}$ (Clamping Voltage) $V_{RSM}$ Volts	Maximum Temperature Coefficient of $V_{BR}$ $\%/^\circ\text{C}$	Device Marking
	$V_{BR}$ @ $I_T$ Volts									
	Min	Nom	Max	mA						
1.5SMC6.8AT3	6.45	6.8	7.14	10	5.8	1000	143	10.5	0.057	6V8A
1.5SMC7.5AT3	7.13	7.5	7.88	10	6.4	500	132	11.3	0.061	7V5A
1.5SMC8.2AT3	7.79	8.2	8.61	10	7.02	200	124	12.1	0.065	8V2A
1.5SMC9.1AT3	8.65	9.1	9.55	1	7.78	50	112	13.4	0.068	9V1A
1.5SMC10AT3	9.5	10	10.5	1	8.55	10	103	14.5	0.073	10A
1.5SMC11AT3	10.5	11	11.6	1	9.4	5	96	15.6	0.075	11A
1.5SMC12AT3	11.4	12	12.6	1	10.2	5	90	16.7	0.078	12A
1.5SMC13AT3	12.4	13	13.7	1	11.1	5	82	18.2	0.081	13A
<b>1.5SMC15AT3</b>	<b>14.3</b>	<b>15</b>	<b>15.8</b>	<b>1</b>	<b>12.8</b>	<b>5</b>	<b>71</b>	<b>21.2</b>	<b>0.084</b>	<b>15A</b>
1.5SMC16AT3	15.2	16	16.8	1	13.6	5	67	22.5	0.086	16A
1.5SMC18AT3	17.1	18	18.9	1	15.3	5	59.5	25.2	0.088	18A
1.5SMC20AT3	19	20	21	1	17.1	5	54	27.7	0.09	20A
1.5SMC22AT3	20.9	22	23.1	1	18.8	5	49	30.6	0.092	22A
<b>1.5SMC24AT3</b>	<b>22.8</b>	<b>24</b>	<b>25.2</b>	<b>1</b>	<b>20.5</b>	<b>5</b>	<b>45</b>	<b>33.2</b>	<b>0.094</b>	<b>24A</b>
1.5SMC27AT3	25.7	27	28.4	1	23.1	5	40	37.5	0.096	27A
1.5SMC30AT3	28.5	30	31.5	1	25.6	5	36	41.4	0.097	30A
<b>1.5SMC33AT3</b>	<b>31.4</b>	<b>33</b>	<b>34.7</b>	<b>1</b>	<b>28.2</b>	<b>5</b>	<b>33</b>	<b>45.7</b>	<b>0.098</b>	<b>33A</b>
<b>1.5SMC36AT3</b>	<b>34.2</b>	<b>36</b>	<b>37.8</b>	<b>1</b>	<b>30.8</b>	<b>5</b>	<b>30</b>	<b>49.9</b>	<b>0.099</b>	<b>36A</b>
<b>1.5SMC39AT3</b>	<b>37.1</b>	<b>39</b>	<b>41</b>	<b>1</b>	<b>33.3</b>	<b>5</b>	<b>28</b>	<b>53.9</b>	<b>0.1</b>	<b>39A</b>
<b>1.5SMC43AT3</b>	<b>40.9</b>	<b>43</b>	<b>45.2</b>	<b>1</b>	<b>36.8</b>	<b>5</b>	<b>25.3</b>	<b>59.3</b>	<b>0.101</b>	<b>43A</b>
<b>1.5SMC47AT3</b>	<b>44.7</b>	<b>47</b>	<b>49.4</b>	<b>1</b>	<b>40.2</b>	<b>5</b>	<b>23.2</b>	<b>64.8</b>	<b>0.101</b>	<b>47A</b>
1.5SMC51AT3	48.5	51	53.6	1	43.6	5	21.4	70.1	0.102	51A
1.5SMC56AT3	53.2	56	58.8	1	47.8	5	19.5	77	0.103	56A
1.5SMC62AT3	58.9	62	65.1	1	53	5	17.7	85	0.104	62A
1.5SMC68AT3	64.6	68	71.4	1	58.1	5	16.3	92	0.104	68A
<b>1.5SMC75AT3</b>	<b>71.3</b>	<b>75</b>	<b>78.8</b>	<b>1</b>	<b>64.1</b>	<b>5</b>	<b>14.6</b>	<b>103</b>	<b>0.105</b>	<b>75A</b>
1.5SMC82AT3	77.9	82	86.1	1	70.1	5	13.3	113	0.105	82A
1.5SMC91AT3	86.5	91	95.5	1	77.8	5	12	125	0.106	91A

\*  $V_{BR}$  measured at pulse test current  $I_T$  at an ambient temperature of  $25^\circ\text{C}$ .

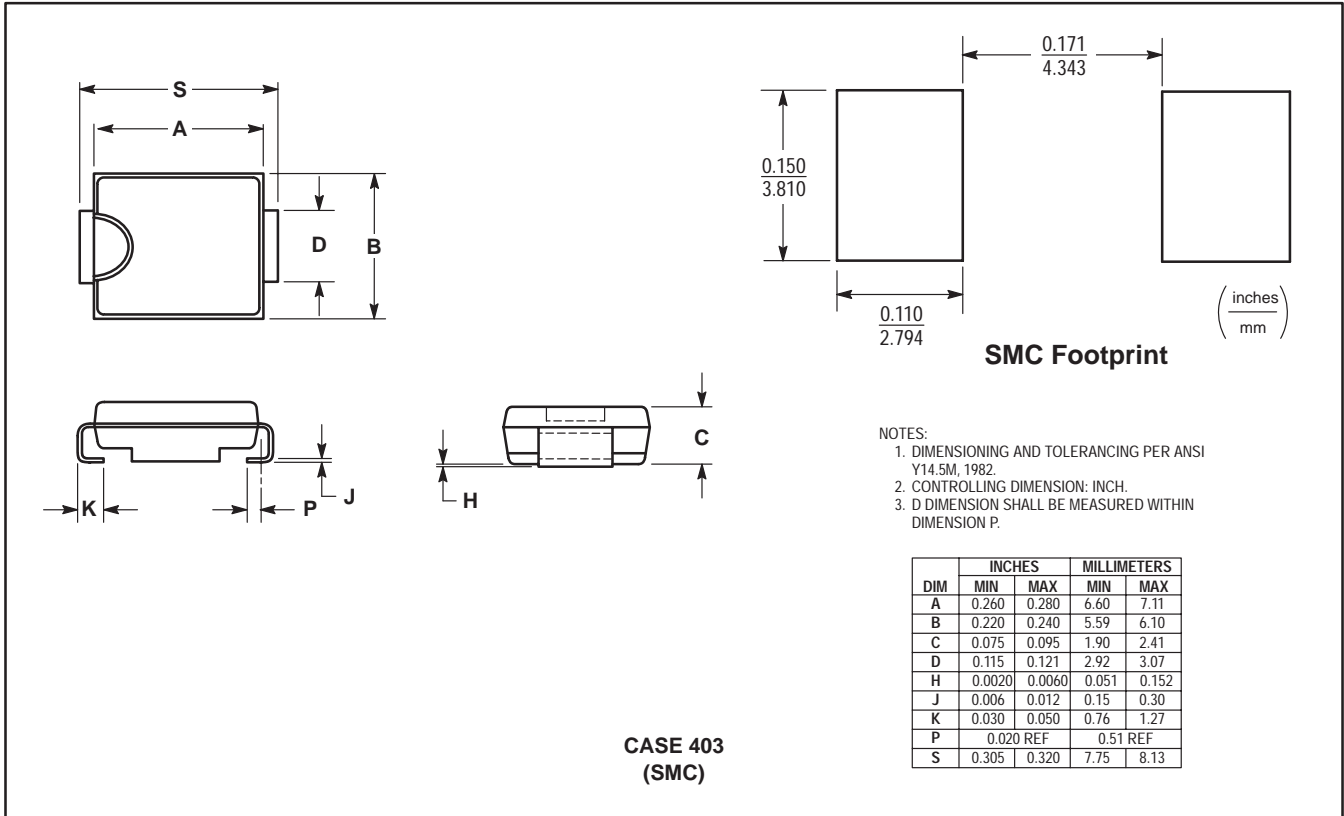
\*\* 1/2 sine wave (or equivalent square wave),  $PW = 8.3\text{ ms}$ , duty cycle = 4 pulses per minute maximum.

† Surge current waveform per Figure 2 and derate per Figure 3 of General Data — 1500 Watt at the beginning of this group.

†† T3 suffix designates tape and reel of 2500 units.

# Transient Voltage Suppressors — Surface Mounted

## 1500 Watt Peak Power



(Refer to Section 10 for Surface Mount, Thermal Data and Footprint Information.)

### MULTIPLE PACKAGE QUANTITY (MPQ) REQUIREMENTS

Package Option	Type No. Suffix	MPQ (Units)
Tape and Reel	T3 (13 inch reel)	2.5K

(Refer to Section 10 for more information on Packaging Specifications.)

# Section Six

## Zener Voltage Regulator Diodes — Axial Leaded Data Sheets

### 500 mW DO-35 Glass

General Data .....	6-2
1N4370A through 1N4372A, 1N746A through 1N759A and 1N957B through 1N992B . NO TAG	
1N4678 through 1N4717 .....	NO TAG
1N5221B through 1N5281B .....	NO TAG
1N5985B through 1N6025B .....	NO TAG
BZX55C2V4RL through BZX55C91RL ....	NO TAG
BZX79C2V4RL through BZX79C200RL ...	NO TAG
BZX83C2V7RL through BZX83C33RL and ZPD2.7RL through ZPD33RL .....	NO TAG
MZ4614 through MZ4627 .....	NO TAG
MZ5520B through MZ5530B .....	NO TAG

### 1–1.3 Watt DO-41 Glass

General Data .....	NO TAG
1N4728A through 1N4764A .....	NO TAG
BZX85C3V3RL through BZX85C100RL ...	NO TAG
MZPY3.9RL through MZPY100RL .....	NO TAG

### 1–3 Watt DO-41 Surmetic 30

General Data .....	NO TAG
1N5913B through 1N5956B .....	NO TAG
3EZ3.9D5 through 3EZ400D5 .....	NO TAG
MZD3.9 through MZD200 .....	NO TAG
MZP4728A through MZP4764A, 1M110ZS5 through 1M200ZS5 .....	NO TAG

### 5 Watt Surmetic 40

1N5333B through 1N5388B .....	6-38
-------------------------------	------

500 mW DO-35 Glass  
 Zener Voltage Regulator Diodes  
**GENERAL DATA APPLICABLE TO ALL SERIES IN THIS GROUP**  
**500 Milliwatt**  
**Hermetically Sealed**  
**Glass Silicon Zener Diodes**

**GENERAL DATA**  
**500 mW DO-35 GLASS**

**GLASS ZENER DIODES**  
**500 MILLIWATTS**  
**1.8–200 VOLTS**



**Specification Features:**

- Complete Voltage Range — 1.8 to 200 Volts
- DO-204AH Package — Smaller than Conventional DO-204AA Package
- Double Slug Type Construction
- Metallurgically Bonded Construction

**Mechanical Characteristics:**

**CASE:** Double slug type, hermetically sealed glass

**MAXIMUM LEAD TEMPERATURE FOR SOLDERING PURPOSES:** 230°C, 1/16" from case for 10 seconds

**FINISH:** All external surfaces are corrosion resistant with readily solderable leads

**POLARITY:** Cathode indicated by color band. When operated in zener mode, cathode will be positive with respect to anode

**MOUNTING POSITION:** Any

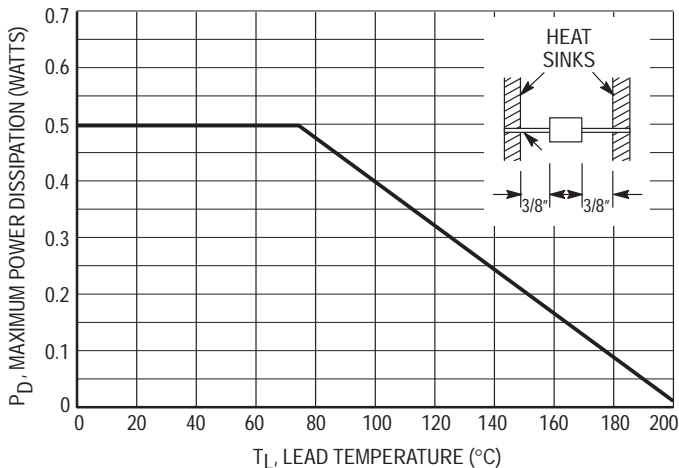
**WAFER FAB LOCATION:** Phoenix, Arizona

**ASSEMBLY/TEST LOCATION:** Seoul, Korea

**MAXIMUM RATINGS (Motorola Devices)\***

Rating	Symbol	Value	Unit
DC Power Dissipation and $T_L \leq 75^\circ\text{C}$ Lead Length = 3/8" Derate above $T_L = 75^\circ\text{C}$	$P_D$	500 4	mW mW/°C
Operating and Storage Temperature Range	$T_J, T_{stg}$	- 65 to +200	°C

\* Some part number series have lower JEDEC registered ratings.



**Figure 1. Steady State Power Derating**

# GENERAL DATA — 500 mW DO-35 GLASS

## APPLICATION NOTE — ZENER VOLTAGE

Since the actual voltage available from a given zener diode is temperature dependent, it is necessary to determine junction temperature under any set of operating conditions in order to calculate its value. The following procedure is recommended:

Lead Temperature,  $T_L$ , should be determined from:

$$T_L = \theta_{LA} P_D + T_A$$

$\theta_{LA}$  is the lead-to-ambient thermal resistance ( $^{\circ}\text{C}/\text{W}$ ) and  $P_D$  is the power dissipation. The value for  $\theta_{LA}$  will vary and depends on the device mounting method.  $\theta_{LA}$  is generally 30 to 40  $^{\circ}\text{C}/\text{W}$  for the various clips and tie points in common use and for printed circuit board wiring.

The temperature of the lead can also be measured using a thermocouple placed on the lead as close as possible to the tie point. The thermal mass connected to the tie point is normally large enough so that it will not significantly respond to heat surges generated in the diode as a result of pulsed operation once steady-state conditions are achieved. Using the measured value of  $T_L$ , the junction temperature may be determined by:

$$T_J = T_L + \Delta T_{JL}$$

$\Delta T_{JL}$  is the increase in junction temperature above the lead temperature and may be found from Figure 2 for dc power:

$$\Delta T_{JL} = \theta_{JL} P_D$$

For worst-case design, using expected limits of  $I_Z$ , limits of  $P_D$  and the extremes of  $T_J$  ( $\Delta T_J$ ) may be estimated. Changes in voltage,  $V_Z$ , can then be found from:

$$\Delta V = \theta_{VZ} T_J$$

$\theta_{VZ}$ , the zener voltage temperature coefficient, is found from Figures 4 and 5.

Under high power-pulse operation, the zener voltage will vary with time and may also be affected significantly by the zener resistance. For best regulation, keep current excursions as low as possible.

Surge limitations are given in Figure 7. They are lower than would be expected by considering only junction temperature, as current crowding effects cause temperatures to be extremely high in small spots, resulting in device degradation should the limits of Figure 7 be exceeded.

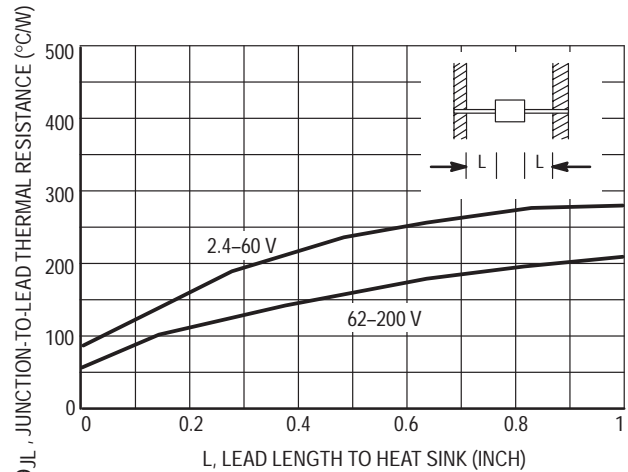


Figure 2. Typical Thermal Resistance

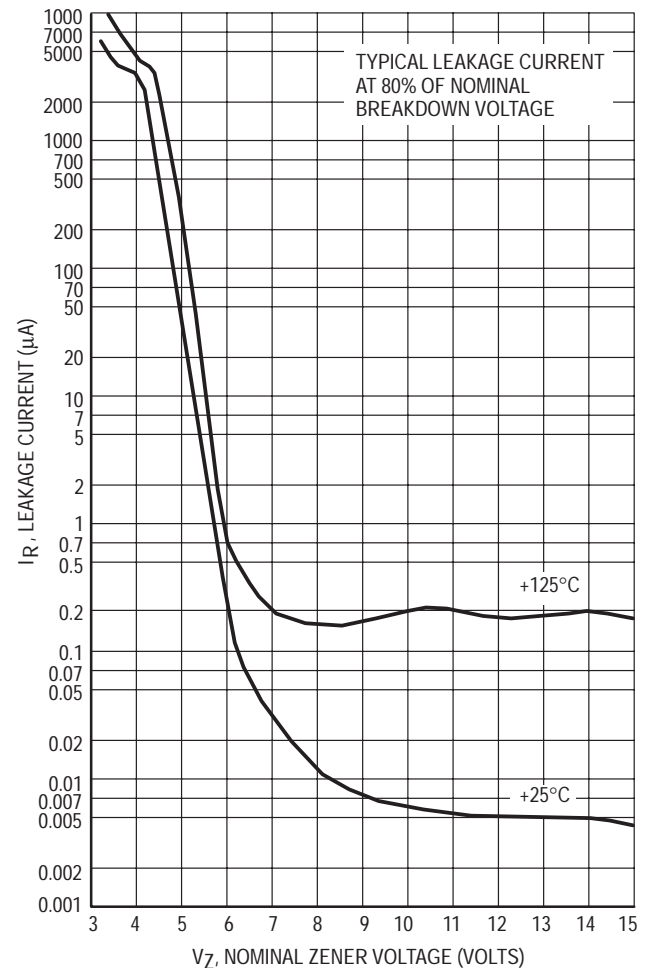


Figure 3. Typical Leakage Current

# GENERAL DATA — 500 mW DO-35 GLASS

## TEMPERATURE COEFFICIENTS

(-55°C to +150°C temperature range; 90% of the units are in the ranges indicated.)

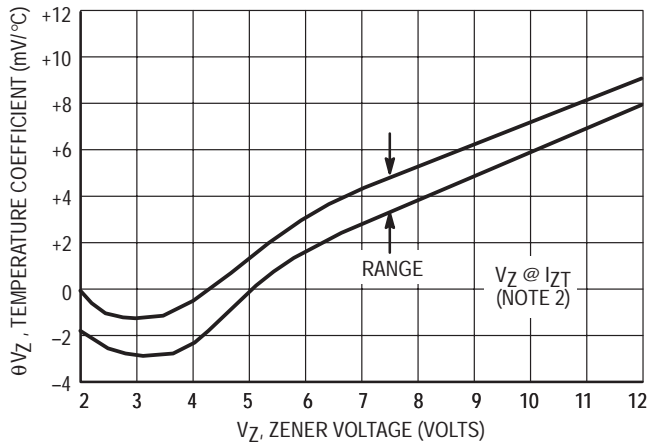


Figure 4a. Range for Units to 12 Volts

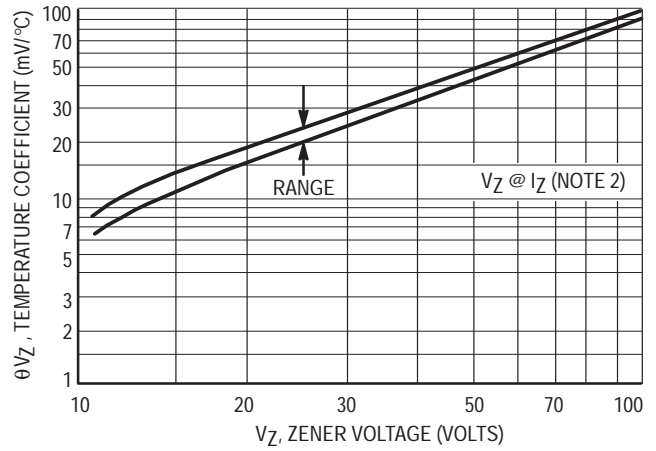


Figure 4b. Range for Units 12 to 100 Volts

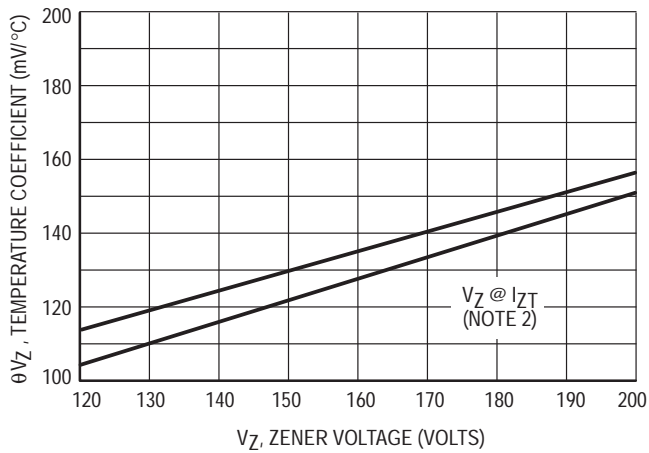


Figure 4c. Range for Units 120 to 200 Volts

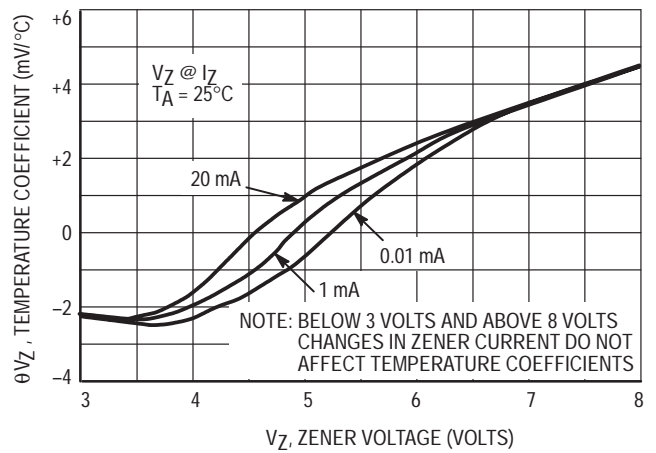


Figure 5. Effect of Zener Current

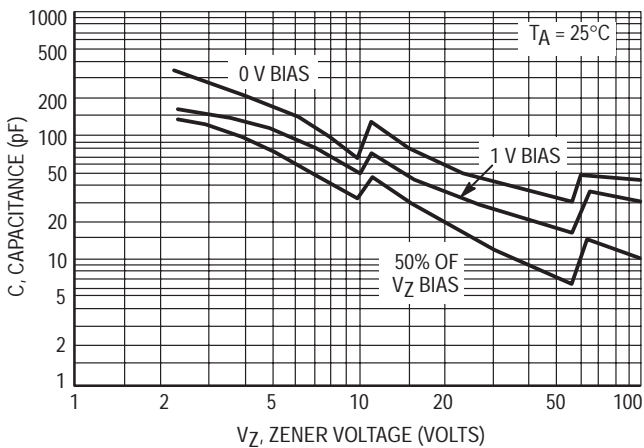


Figure 6a. Typical Capacitance 2.4-100 Volts

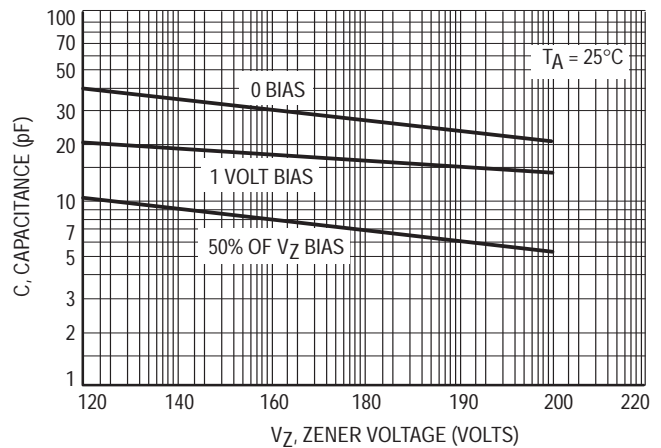
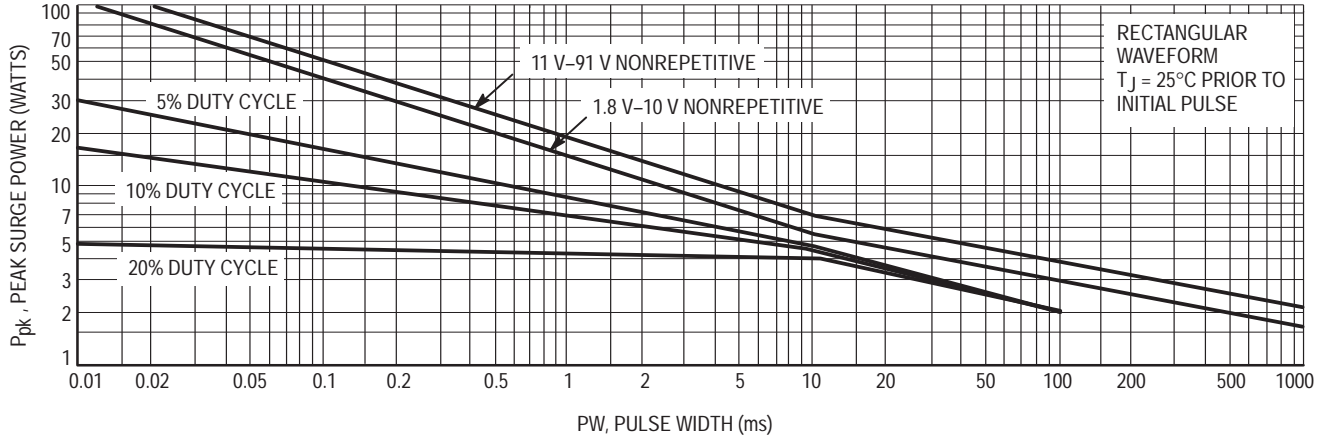
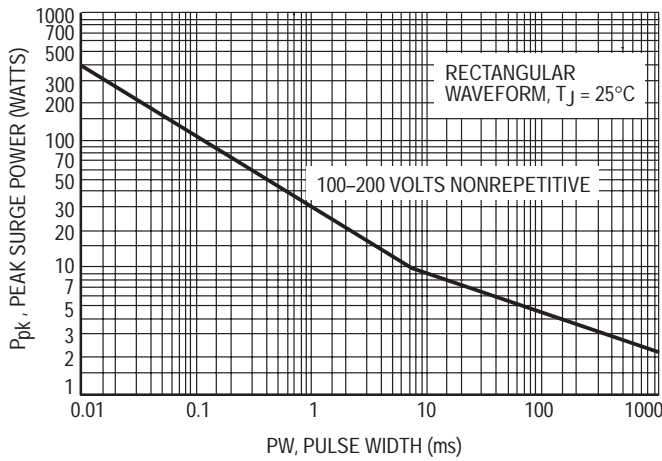


Figure 6b. Typical Capacitance 120-200 Volts

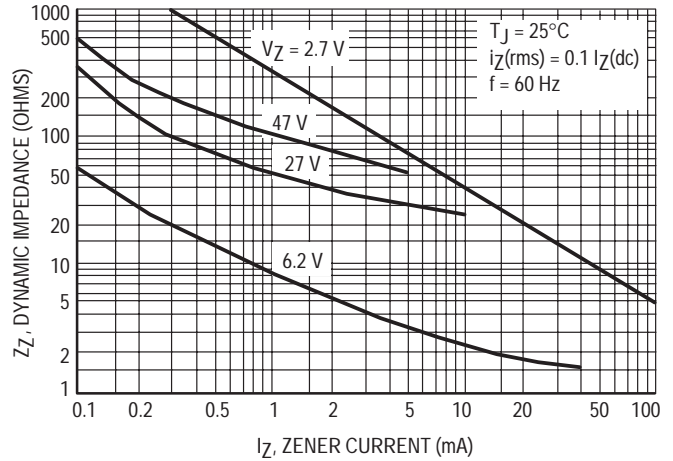
# GENERAL DATA — 500 mW DO-35 GLASS



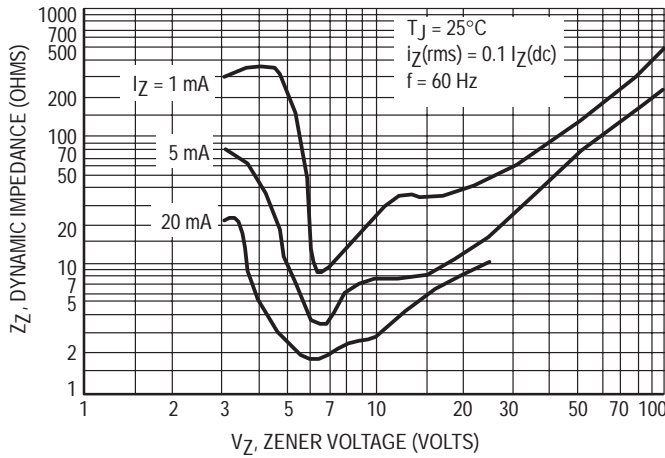
**Figure 7a. Maximum Surge Power 1.8-91 Volts**



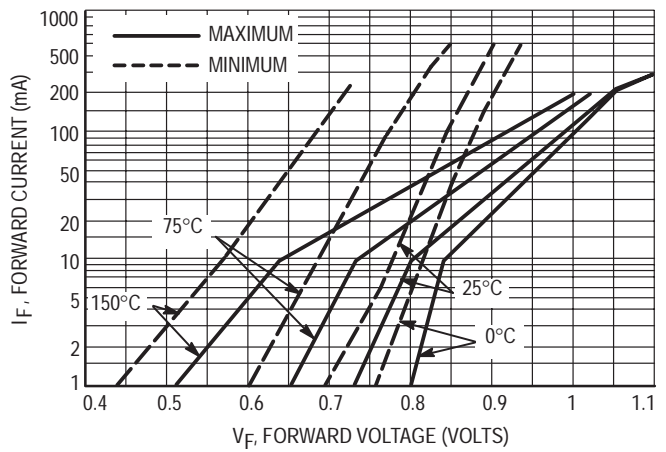
**Figure 7b. Maximum Surge Power DO-204AH 100-200 Volts**



**Figure 8. Effect of Zener Current on Zener Impedance**



**Figure 9. Effect of Zener Voltage on Zener Impedance**



**Figure 10. Typical Forward Characteristics**



# GENERAL DATA — 500 mW DO-35 GLASS

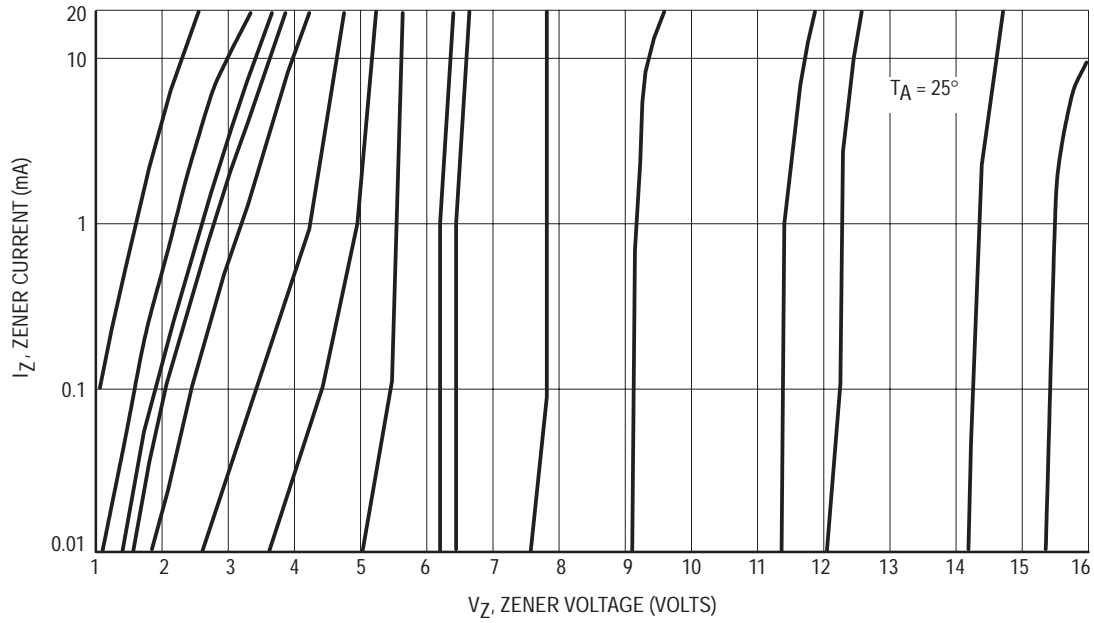


Figure 11. Zener Voltage versus Zener Current —  $V_Z = 1$  thru 16 Volts

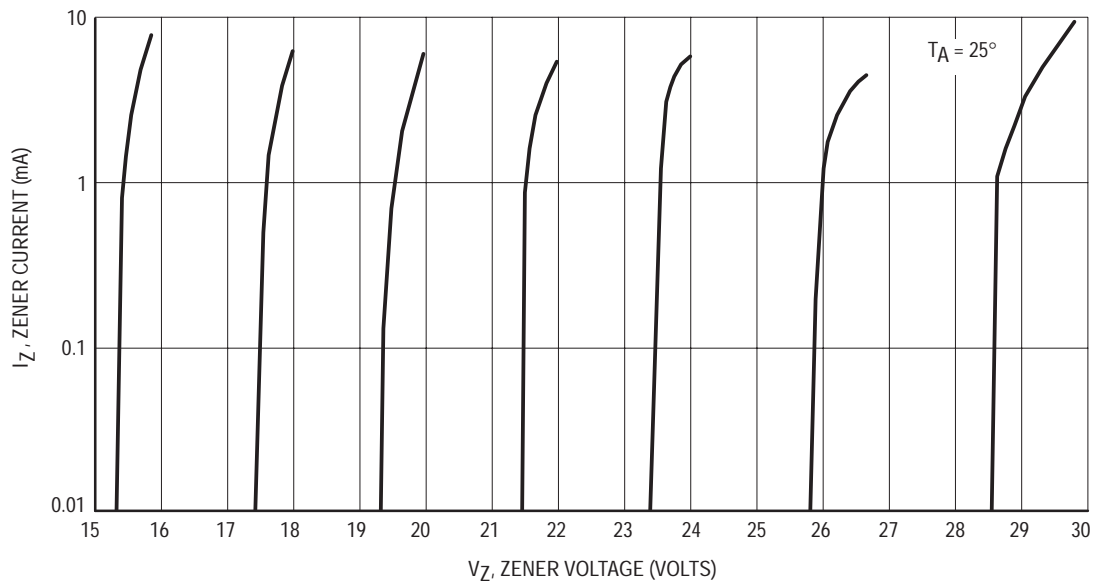


Figure 12. Zener Voltage versus Zener Current —  $V_Z = 15$  thru 30 Volts

# GENERAL DATA — 500 mW DO-35 GLASS

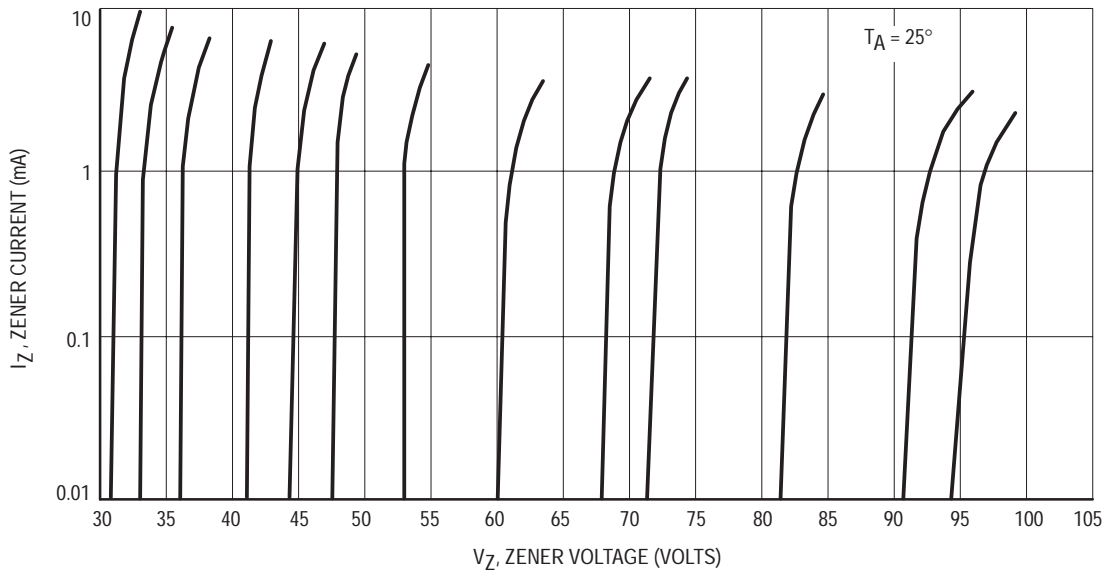


Figure 13. Zener Voltage versus Zener Current —  $V_Z = 30$  thru 105 Volts

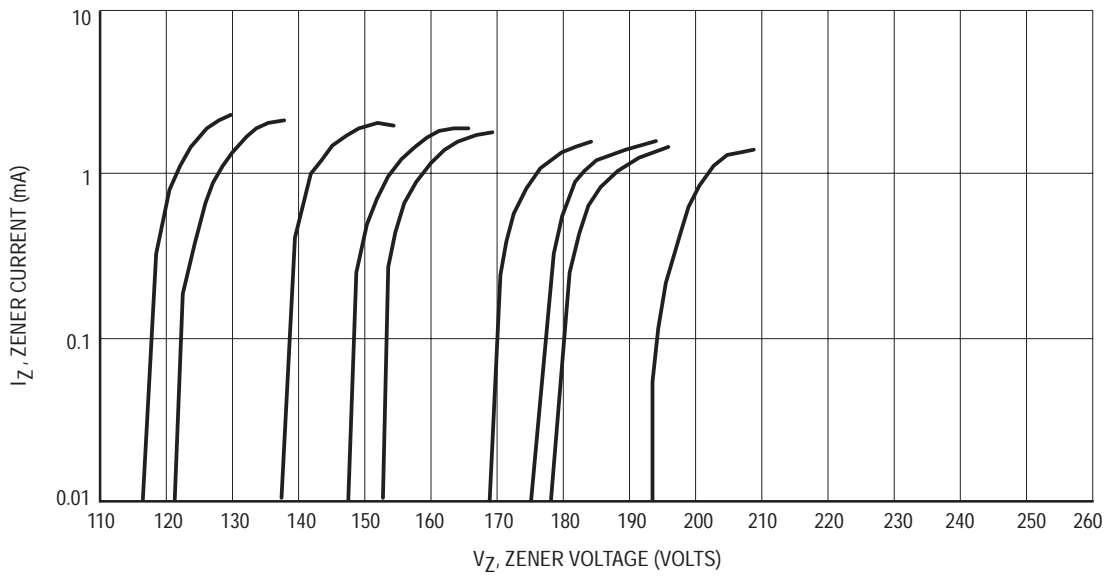


Figure 14. Zener Voltage versus Zener Current —  $V_Z = 110$  thru 220 Volts

# GENERAL DATA — 500 mW DO-35 GLASS

**ELECTRICAL CHARACTERISTICS** ( $T_A = 25^\circ\text{C}$ ,  $V_F = 1.5\text{ V}$  Max at 200 mA for all types)

Type Number (Note 1)	Nominal Zener Voltage $V_Z$ @ $I_{ZT}$ (Note 2) Volts	Test Current $I_{ZT}$ mA	Maximum Zener Impedance $Z_{ZT}$ @ $I_{ZT}$ (Note 3) Ohms	Maximum DC Zener Current $I_{ZM}$ (Note 4) mA	Maximum Reverse Leakage Current	
					$T_A = 25^\circ\text{C}$ $I_R$ @ $V_R = 1\text{ V}$ $\mu\text{A}$	$T_A = 150^\circ\text{C}$ $I_R$ @ $V_R = 1\text{ V}$ $\mu\text{A}$
1N4370A	2.4	20	30	150	100	200
1N4371A	2.7	20	30	135	75	150
1N4372A	3	20	29	120	50	100
<b>1N746A</b>	<b>3.3</b>	<b>20</b>	<b>28</b>	<b>110</b>	<b>10</b>	<b>30</b>
1N747A	3.6	20	24	100	10	30
1N748A	3.9	20	23	95	10	30
1N749A	4.3	20	22	85	2	30
1N750A	4.7	20	19	75	2	30
<b>1N751A</b>	<b>5.1</b>	<b>20</b>	<b>17</b>	<b>70</b>	<b>1</b>	<b>20</b>
<b>1N752A</b>	<b>5.6</b>	<b>20</b>	<b>11</b>	<b>65</b>	<b>1</b>	<b>20</b>
<b>1N753A</b>	<b>6.2</b>	<b>20</b>	<b>7</b>	<b>60</b>	<b>0.1</b>	<b>20</b>
1N754A	6.8	20	5	55	0.1	20
1N755A	7.5	20	6	50	0.1	20
1N756A	8.2	20	8	45	0.1	20
1N757A	9.1	20	10	40	0.1	20
1N758A	10	20	17	35	0.1	20
1N759A	12	20	30	30	0.1	20

Type Number (Note 1)	Nominal Zener Voltage $V_Z$ (Note 2) Volts	Test Current $I_{ZT}$ mA	Maximum Zener Impedance (Note 3)			Maximum DC Zener Current $I_{ZM}$ (Note 4) mA	Maximum Reverse Current	
			$Z_{ZT}$ @ $I_{ZT}$ Ohms	$Z_{ZK}$ @ $I_{ZK}$ Ohms	$I_{ZK}$ mA		$I_R$ Maximum $\mu\text{A}$	Test Voltage Vdc $V_R$
1N957B	6.8	18.5	4.5	700	1	47	150	5.2
1N958B	7.5	16.5	5.5	700	0.5	42	75	5.7
1N959B	8.2	15	6.5	700	0.5	38	50	6.2
1N960B	9.1	14	7.5	700	0.5	35	25	6.9
1N961B	10	12.5	8.5	700	0.25	32	10	7.6
1N962B	11	11.5	9.5	700	0.25	28	5	8.4
1N963B	12	10.5	11.5	700	0.25	26	5	9.1
1N964B	13	9.5	13	700	0.25	24	5	9.9
1N965B	15	8.5	16	700	0.25	21	5	11.4
1N966B	16	7.8	17	700	0.25	19	5	12.2
1N967B	18	7	21	750	0.25	17	5	13.7
1N968B	20	6.2	25	750	0.25	15	5	15.2
1N969B	22	5.6	29	750	0.25	14	5	16.7
1N970B	24	5.2	33	750	0.25	13	5	18.2
1N971B	27	4.6	41	750	0.25	11	5	20.6
1N972B	30	4.2	49	1000	0.25	10	5	22.8
1N973B	33	3.8	58	1000	0.25	9.2	5	25.1
1N974B	36	3.4	70	1000	0.25	8.5	5	27.4
1N975B	39	3.2	80	1000	0.25	7.8	5	29.7
1N976B	43	3	93	1500	0.25	7	5	32.7
1N977B	47	2.7	105	1500	0.25	6.4	5	35.8
1N978B	51	2.5	125	1500	0.25	5.9	5	38.8
1N979B	56	2.2	150	2000	0.25	5.4	5	42.6
1N980B	62	2	185	2000	0.25	4.9	5	47.1

# GENERAL DATA — 500 mW DO-35 GLASS

Type Number (Note 1)	Nominal Zener Voltage $V_Z$ (Note 2) Volts	Test Current $I_{ZT}$ mA	Maximum Zener Impedance (Note 3)			Maximum DC Zener Current $I_{ZM}$ (Note 4) mA	Maximum Reverse Leakage Current	
			$Z_{ZT}$ @ $I_{ZT}$ Ohms	$Z_{ZK}$ @ $I_{ZK}$ Ohms	$I_{ZK}$ mA		$I_R$ Maximum $\mu A$	Test Voltage Vdc $V_R$
1N981B	68	1.8	230	2000	0.25	4.5	5	51.7
1N982B	75	1.7	270	2000	0.25	4.1	5	56
1N983B	82	1.5	330	3000	0.25	3.7	5	62.2
1N984B	91	1.4	400	3000	0.25	3.3	5	69.2
1N985B	100	1.3	500	3000	0.25	3	5	76
1N986B	110	1.1	750	4000	0.25	2.7	5	83.6
1N987B	120	1	900	4500	0.25	2.5	5	91.2
1N988B	130	0.95	1100	5000	0.25	2.3	5	98.8
1N989B	150	0.85	1500	6000	0.25	2	5	114
1N990B	160	0.8	1700	6500	0.25	1.9	5	121.6
1N991B	180	0.68	2200	7100	0.25	1.7	5	136.8
1N992B	200	0.65	2500	8000	0.25	1.5	5	152

**NOTE 1. TOLERANCE AND VOLTAGE DESIGNATION**

**Tolerance Designation**

The type numbers shown have tolerance designations as follows:

- 1N4370A series:  $\pm 5\%$  units, C for  $\pm 2\%$ , D for  $\pm 1\%$ .
- 1N746A series:  $\pm 5\%$  units, C for  $\pm 2\%$ , D for  $\pm 1\%$ .
- 1N957B series:  $\pm 5\%$  units, C for  $\pm 2\%$ , D for  $\pm 1\%$ .

**NOTE 2. ZENER VOLTAGE ( $V_Z$ ) MEASUREMENT**

Nominal zener voltage is measured with the device junction in thermal equilibrium at the lead temperature of  $30^\circ\text{C} \pm 1^\circ\text{C}$  and 3/8" lead length.

**NOTE 3. ZENER IMPEDANCE ( $Z_Z$ ) DERIVATION**

$Z_{ZT}$  and  $Z_{ZK}$  are measured by dividing the ac voltage drop across the device by the ac current applied. The specified limits are for  $I_Z(\text{ac}) = 0.1 I_Z(\text{dc})$  with the ac frequency = 60 Hz.

**NOTE 4. MAXIMUM ZENER CURRENT RATINGS ( $I_{ZM}$ )**

Values shown are based on the JEDEC rating of 400 mW. Where the actual zener voltage ( $V_Z$ ) is known at the operating point, the maximum zener current may be increased and is limited by the derating curve.

# GENERAL DATA — 500 mW DO-35 GLASS

Low level oxide passivated zener diodes for applications requiring extremely low operating currents, low leakage, and sharp breakdown voltage.

- Zener Voltage Specified @  $I_{ZT} = 50 \mu\text{A}$
- Maximum Delta  $V_Z$  Given from 10 to 100  $\mu\text{A}$

## ELECTRICAL CHARACTERISTICS ( $T_A = 25^\circ\text{C}$ , $V_F = 1.5 \text{ V}$ Max at $I_F = 100 \text{ mA}$ for all types)

Type Number (Note 1)	Zener Voltage $V_Z$ @ $I_{ZT} = 50 \mu\text{A}$ Volts			Maximum Reverse Current $I_R \mu\text{A}$  (Note 3)	Test Voltage $V_R$ Volts	Maximum Zener Current $I_{ZM} \text{ mA}$ (Note 2)	Maximum Voltage Change $\Delta V_Z$ Volts (Note 4)
	Nom (Note 1)	Min	Max				
1N4678	1.8	1.71	1.89	7.5	1	120	0.7
1N4679	2	1.9	2.1	5	1	110	0.7
1N4680	2.2	2.09	2.31	4	1	100	0.75
1N4681	2.4	2.28	2.52	2	1	95	0.8
1N4682	2.7	2.565	2.835	1	1	90	0.85
1N4683	3	2.85	3.15	0.8	1	85	0.9
1N4684	3.3	3.135	3.465	7.5	1.5	80	0.95
1N4685	3.6	3.42	3.78	7.5	2	75	0.95
1N4686	3.9	3.705	4.095	5	2	70	0.97
1N4687	4.3	4.085	4.515	4	2	65	0.99
<b>1N4688</b>	<b>4.7</b>	<b>4.465</b>	<b>4.935</b>	<b>10</b>	<b>3</b>	<b>60</b>	<b>0.99</b>
1N4689	5.1	4.845	5.355	10	3	55	0.97
1N4690	5.6	5.32	5.88	10	4	50	0.96
1N4691	6.2	5.89	6.51	10	5	45	0.95
1N4692	6.8	6.46	7.14	10	5.1	35	0.9
1N4693	7.5	7.125	7.875	10	5.7	31.8	0.75
1N4694	8.2	7.79	8.61	1	6.2	29	0.5
1N4695	8.7	8.265	9.135	1	6.6	27.4	0.1
1N4696	9.1	8.645	9.555	1	6.9	26.2	0.08
1N4697	10	9.5	10.5	1	7.6	24.8	0.1
1N4698	11	10.45	11.55	0.05	8.4	21.6	0.11
1N4699	12	11.4	12.6	0.05	9.1	20.4	0.12
1N4700	13	12.35	13.65	0.05	9.8	19	0.13
1N4701	14	13.3	14.7	0.05	10.6	17.5	0.14
1N4702	15	14.25	15.75	0.05	11.4	16.3	0.15
1N4703	16	15.2	16.8	0.05	12.1	15.4	0.16
1N4704	17	16.15	17.85	0.05	12.9	14.5	0.17
1N4705	18	17.1	18.9	0.05	13.6	13.2	0.18
1N4706	19	18.05	19.95	0.05	14.4	12.5	0.19
1N4707	20	19	21	0.01	15.2	11.9	0.2
1N4708	22	20.9	23.1	0.01	16.7	10.8	0.22
1N4709	24	22.8	25.2	0.01	18.2	9.9	0.24
1N4710	25	23.75	26.25	0.01	19	9.5	0.25
1N4711	27	25.65	28.35	0.01	20.4	8.8	0.27
1N4712	28	26.6	29.4	0.01	21.2	8.5	0.28
1N4713	30	28.5	31.5	0.01	22.8	7.9	0.3
1N4714	33	31.35	34.65	0.01	25	7.2	0.33
1N4715	36	34.2	37.8	0.01	27.3	6.6	0.36
1N4716	39	37.05	40.95	0.01	29.6	6.1	0.39
1N4717	43	40.85	45.15	0.01	32.6	5.5	0.43

### NOTE 1. TOLERANCE AND VOLTAGE DESIGNATION ( $V_Z$ )

The type numbers shown have a standard tolerance of  $\pm 5\%$  on the nominal Zener voltage, C for  $\pm 2\%$ , D for  $\pm 1\%$ .

### NOTE 2. MAXIMUM ZENER CURRENT RATINGS ( $I_{ZM}$ )

Maximum Zener current ratings are based on maximum Zener voltage of the individual units and JEDEC 250 mW rating.

### NOTE 3. REVERSE LEAKAGE CURRENT ( $I_R$ )

Reverse leakage currents are guaranteed and measured at  $V_R$  as shown on the table.

### NOTE 4. MAXIMUM VOLTAGE CHANGE ( $\Delta V_Z$ )

Voltage change is equal to the difference between  $V_Z$  at 100  $\mu\text{A}$  and  $V_Z$  at 10  $\mu\text{A}$ .

### NOTE 5. ZENER VOLTAGE ( $V_Z$ ) MEASUREMENT

Nominal Zener voltage is measured with the device junction in thermal equilibrium at the lead temperature at  $30^\circ\text{C} \pm 1^\circ\text{C}$  and 3/8" lead length.

# GENERAL DATA — 500 mW DO-35 GLASS

**ELECTRICAL CHARACTERISTICS** ( $T_A = 25^\circ\text{C}$  unless otherwise noted. Based on dc measurements at thermal equilibrium; lead length = 3/8"; thermal resistance of heat sink = 30°C/W)  $V_F = 1.1$  Max @  $I_F = 200$  mA for all types.

JEDEC Type No. (Note 1)	Nominal Zener Voltage $V_Z$ @ $I_{ZT}$ Volts (Note 3)	Test Current $I_{ZT}$ mA	Max Zener Impedance (Note 4)		Max Reverse Leakage Current		Max Zener Voltage Temperature Coeff. $\theta_{VZ}$ (%/°C) (Note 2)
			$Z_{ZT}$ @ $I_{ZT}$ Ohms	$Z_{ZK}$ @ $I_{ZK} = 0.25$ mA Ohms	$I_R$ $\mu\text{A}$	$V_R$ Volts	
1N5221B	2.4	20	30	1200	100	1	-0.085
1N5222B	2.5	20	30	1250	100	1	-0.085
1N5223B	2.7	20	30	1300	75	1	-0.08
1N5224B	2.8	20	30	1400	75	1	-0.08
1N5225B	3	20	29	1600	50	1	-0.075
<b>1N5226B</b>	<b>3.3</b>	<b>20</b>	<b>28</b>	<b>1600</b>	<b>25</b>	<b>1</b>	<b>-0.07</b>
1N5227B	3.6	20	24	1700	15	1	-0.065
<b>1N5228B</b>	<b>3.9</b>	<b>20</b>	<b>23</b>	<b>1900</b>	<b>10</b>	<b>1</b>	<b>-0.06</b>
1N5229B	4.3	20	22	2000	5	1	$\pm 0.055$
1N5230B	4.7	20	19	1900	5	2	$\pm 0.03$
<b>1N5231B</b>	<b>5.1</b>	<b>20</b>	<b>17</b>	<b>1600</b>	<b>5</b>	<b>2</b>	<b><math>\pm 0.03</math></b>
<b>1N5232B</b>	<b>5.6</b>	<b>20</b>	<b>11</b>	<b>1600</b>	<b>5</b>	<b>3</b>	<b>+0.038</b>
1N5233B	6	20	7	1600	5	3.5	+0.038
<b>1N5234B</b>	<b>6.2</b>	<b>20</b>	<b>7</b>	<b>1000</b>	<b>5</b>	<b>4</b>	<b>+0.045</b>
<b>1N5235B</b>	<b>6.8</b>	<b>20</b>	<b>5</b>	<b>750</b>	<b>3</b>	<b>5</b>	<b>+0.05</b>
1N5236B	7.5	20	6	500	3	6	+0.058
<b>1N5237B</b>	<b>8.2</b>	<b>20</b>	<b>8</b>	<b>500</b>	<b>3</b>	<b>6.5</b>	<b>+0.062</b>
1N5238B	8.7	20	8	600	3	6.5	+0.065
1N5239B	9.1	20	10	600	3	7	+0.068
<b>1N5240B</b>	<b>10</b>	<b>20</b>	<b>17</b>	<b>600</b>	<b>3</b>	<b>8</b>	<b>+0.075</b>
1N5241B	11	20	22	600	2	8.4	+0.076
<b>1N5242B</b>	<b>12</b>	<b>20</b>	<b>30</b>	<b>600</b>	<b>1</b>	<b>9.1</b>	<b>+0.077</b>
1N5243B	13	9.5	13	600	0.5	9.9	+0.079
1N5244B	14	9	15	600	0.1	10	+0.082
<b>1N5245B</b>	<b>15</b>	<b>8.5</b>	<b>16</b>	<b>600</b>	<b>0.1</b>	<b>11</b>	<b>+0.082</b>
<b>1N5246B</b>	<b>16</b>	<b>7.8</b>	<b>17</b>	<b>600</b>	<b>0.1</b>	<b>12</b>	<b>+0.083</b>
1N5247B	17	7.4	19	600	0.1	13	+0.084
1N5248B	18	7	21	600	0.1	14	+0.085
1N5249B	19	6.6	23	600	0.1	14	+0.086
<b>1N5250B</b>	<b>20</b>	<b>6.2</b>	<b>25</b>	<b>600</b>	<b>0.1</b>	<b>15</b>	<b>+0.086</b>
1N5251B	22	5.6	29	600	0.1	17	+0.087
1N5252B	24	5.2	33	600	0.1	18	+0.088
1N5253B	25	5	35	600	0.1	19	+0.089
1N5254B	27	4.6	41	600	0.1	21	+0.09
1N5255B	28	4.5	44	600	0.1	21	+0.091
1N5256B	30	4.2	49	600	0.1	23	+0.091
1N5257B	33	3.8	58	700	0.1	25	+0.092
1N5258B	36	3.4	70	700	0.1	27	+0.093
1N5259B	39	3.2	80	800	0.1	30	+0.094
1N5260B	43	3	93	900	0.1	33	+0.095
1N5261B	47	2.7	105	1000	0.1	36	+0.095
1N5262B	51	2.5	125	1100	0.1	39	+0.096
1N5263B	56	2.2	150	1300	0.1	43	+0.096
1N5264B	60	2.1	170	1400	0.1	46	+0.097
1N5265B	62	2	185	1400	0.1	47	+0.097

(continued)

# GENERAL DATA — 500 mW DO-35 GLASS

**ELECTRICAL CHARACTERISTICS — continued** ( $T_A = 25^\circ\text{C}$  unless otherwise noted. Based on dc measurements at thermal equilibrium; lead length = 3/8"; thermal resistance of heat sink =  $30^\circ\text{C/W}$ )  $V_F = 1.1$  Max @  $I_F = 200$  mA for all types.

JEDEC Type No. (Note 1)	Nominal Zener Voltage $V_Z$ @ $I_{ZT}$ Volts (Note 3)	Test Current $I_{ZT}$ mA	Max Zener Impedance (Note 4)		Max Reverse Leakage Current		Max Zener Voltage Temperature Coeff. $\theta_{VZ}$ (%/°C) (Note 2)
			$Z_{ZT}$ @ $I_{ZT}$ Ohms	$Z_{ZK}$ @ $I_{ZK} = 0.25$ mA Ohms	$I_R$ $\mu\text{A}$	$V_R$ Volts	
1N5266B	68	1.8	230	1600	0.1	52	+0.097
1N5267B	75	1.7	270	1700	0.1	56	+0.098
1N5268B	82	1.5	330	2000	0.1	62	+0.098
1N5269B	87	1.4	370	2200	0.1	68	+0.099
1N5270B	91	1.4	400	2300	0.1	69	+0.099
1N5271B	100	1.3	500	2600	0.1	76	+0.11
1N5272B	110	1.1	750	3000	0.1	84	+0.11
1N5273B	120	1	900	4000	0.1	91	+0.11
1N5274B	130	0.95	1100	4500	0.1	99	+0.11
1N5275B	140	0.9	1300	4500	0.1	106	+0.11
1N5276B	150	0.85	1500	5000	0.1	114	+0.11
1N5277B	160	0.8	1700	5500	0.1	122	+0.11
1N5278B	170	0.74	1900	5500	0.1	129	+0.11
1N5279B	180	0.68	2200	6000	0.1	137	+0.11
1N5280B	190	0.66	2400	6500	0.1	144	+0.11
1N5281B	200	0.65	2500	7000	0.1	152	+0.11

#### NOTE 1. TOLERANCE

The JEDEC type numbers shown indicate a tolerance of  $\pm 5\%$ . For tighter tolerance devices use suffixes "C" for  $\pm 2\%$  and "D" for  $\pm 1\%$ .

#### NOTE 2. TEMPERATURE COEFFICIENT ( $\theta_{VZ}$ )<sup>†</sup>

Test conditions for temperature coefficient are as follows:

- $I_{ZT} = 7.5$  mA,  $T_1 = 25^\circ\text{C}$ ,  
 $T_2 = 125^\circ\text{C}$  (1N5221B through 1N5242B).
- $I_{ZT} = \text{Rated } I_{ZT}$ ,  $T_1 = 25^\circ\text{C}$ ,  
 $T_2 = 125^\circ\text{C}$  (1N5243B through 1N5281B).

Device to be temperature stabilized with current applied prior to reading breakdown voltage at the specified ambient temperature.

#### NOTE 3. ZENER VOLTAGE ( $V_Z$ ) MEASUREMENT

Nominal zener voltage is measured with the device junction in thermal equilibrium at the lead temperature of  $30^\circ\text{C} \pm 1^\circ\text{C}$  and 3/8" lead length.

#### NOTE 4. ZENER IMPEDANCE ( $Z_Z$ ) DERIVATION

$Z_{ZT}$  and  $Z_{ZK}$  are measured by dividing the ac voltage drop across the device by the ac current applied. The specified limits are for  $I_Z(\text{ac}) = 0.1 I_Z(\text{dc})$  with the ac frequency = 60 Hz.

<sup>†</sup> For more information on special selections contact your nearest Motorola representative.

# GENERAL DATA — 500 mW DO-35 GLASS

\*ELECTRICAL CHARACTERISTICS ( $T_L = 30^\circ\text{C}$  unless otherwise noted.) ( $V_F = 1.5$  Volts Max @  $I_F = 100$  mAdc for all types.)

Motorola Type Number (Note 1)	Nominal Zener Voltage $V_Z$ @ $I_{ZT}$ Volts (Note 4)	Test Current $I_{ZT}$ mA	Max Zener Impedance (Note 3)		Max Reverse Leakage Current		Max DC Zener Current $I_{ZM}$ (Note 2)
			$Z_{ZT}$ @ $I_{ZT}$ Ohms	$Z_{ZK}$ @ $I_{ZK} = 0.25$ mA	$I_R$ $\mu\text{A}$	@ $V_R$ Volts	
1N5985B	2.4	5	100	1800	100	1	208
1N5986B	2.7	5	100	1900	75	1	185
1N5987B	3	5	95	2000	50	1	167
1N5988B	3.3	5	95	2200	25	1	152
1N5989B	3.6	5	90	2300	15	1	139
1N5990B	3.9	5	90	2400	10	1	128
1N5991B	4.3	5	88	2500	5	1	116
1N5992B	4.7	5	70	2200	3	1.5	106
<b>1N5993B</b>	<b>5.1</b>	<b>5</b>	<b>50</b>	<b>2050</b>	<b>2</b>	<b>2</b>	<b>98</b>
<b>1N5994B</b>	<b>5.6</b>	<b>5</b>	<b>25</b>	<b>1800</b>	<b>2</b>	<b>3</b>	<b>89</b>
1N5995B	6.2	5	10	1300	1	4	81
1N5996B	6.8	5	8	750	1	5.2	74
1N5997B	7.5	5	7	600	0.5	6	67
<b>1N5998B</b>	<b>8.2</b>	<b>5</b>	<b>7</b>	<b>600</b>	<b>0.5</b>	<b>6.5</b>	<b>61</b>
1N5999B	9.1	5	10	600	0.1	7	55
1N6000B	10	5	15	600	0.1	8	50
1N6001B	11	5	18	600	0.1	8.4	45
1N6002B	12	5	22	600	0.1	9.1	42
1N6003B	13	5	25	600	0.1	9.9	38
1N6004B	15	5	32	600	0.1	11	33
1N6005B	16	5	36	600	0.1	12	31
1N6006B	18	5	42	600	0.1	14	28
1N6007B	20	5	48	600	0.1	15	25
1N6008B	22	5	55	600	0.1	17	23
1N6009B	24	5	62	600	0.1	18	21
1N6010B	27	5	70	600	0.1	21	19
1N6011B	30	5	78	600	0.1	23	17
1N6012B	33	5	88	700	0.1	25	15
1N6013B	36	5	95	700	0.1	27	14
1N6014B	39	2	130	800	0.1	30	13
1N6015B	43	2	150	900	0.1	33	12
1N6016B	47	2	170	1000	0.1	36	11
1N6017B	51	2	180	1300	0.1	39	9.8
1N6018B	56	2	200	1400	0.1	43	8.9
1N6019B	62	2	225	1400	0.1	47	8
1N6020B	68	2	240	1600	0.1	52	7.4
1N6021B	75	2	265	1700	0.1	56	6.7
1N6022B	82	2	280	2000	0.1	62	6.1
1N6023B	91	2	300	2300	0.1	69	5.5
1N6024B	100	1	500	2600	0.1	76	5
1N6025B	110	1	650	3000	0.1	84	4.5

\*Indicates JEDEC Registered Data

**NOTE 1. TOLERANCE AND VOLTAGE DESIGNATION**

Tolerance designation — Device tolerances of  $\pm 5\%$  are indicated by a "B" suffix,  $\pm 2\%$  by a "C" suffix,  $\pm 1\%$  by a "D" suffix.

**NOTE 2.**

This data was calculated using nominal voltages. The maximum current handling capability on a worst case basis is limited by the actual zener voltage at the operating point and the power derating curve.

**NOTE 3.**

$Z_{ZT}$  and  $Z_{ZK}$  are measured by dividing the ac voltage drop across the device by the ac current applied. The specified limits are for  $I_Z(\text{ac}) = 0.1 I_Z(\text{dc})$  with the ac frequency = 1.0 kHz.

**NOTE 4.**

Nominal Zener Voltage ( $V_Z$ ) is measured with the device junction in thermal equilibrium at the lead temperature of  $30^\circ\text{C} \pm 1^\circ\text{C}$  and 3/8" lead length.



# GENERAL DATA — 500 mW DO-35 GLASS

**ELECTRICAL CHARACTERISTICS** ( $T_L = 30^\circ\text{C}$  unless otherwise noted.) ( $V_F = 1.3$  Volts Max,  $I_F = 100$  mAdc for all types.)

Motorola Type Number	$V_{ZT}$ at $I_{ZT}$ (V)		Max Zener Impedance (Note 3) $Z_{ZT}$ @ $I_{ZT}$ (Ohms) Max	$I_{ZT}$ (mA)	Max Reverse Leakage Current $I_R$ at $V_R$ ( $\mu\text{A}$ )		$V_R$ (V)	$I_{ZM}$ (mA) (Note 2)
	Min (Note 1)	Max (Note 1)			$T_{amb}$ $25^\circ\text{C}$ Max	$T_{amb}$ $125^\circ\text{C}$ Max		
BZX55C2V4RL	2.28	2.56	85	5	50	100	1	155
BZX55C2V7RL	2.5	2.9	85	5	10	50	1	135
BZX55C3V0RL	2.8	3.2	85	5	4	40	1	125
BZX55C3V3RL	3.1	3.5	85	5	2	40	1	115
BZX55C3V6RL	3.4	3.8	85	5	2	40	1	105
BZX55C3V9RL	3.7	4.1	85	5	2	40	1	95
BZX55C4V3RL	4	4.6	75	5	1	20	1	90
BZX55C4V7RL	4.4	5	60	5	0.5	10	1	85
BZX55C5V1RL	4.8	5.4	35	5	0.1	2	1	80
BZX55C5V6RL	5.2	6	25	5	0.1	2	1	70
BZX55C6V2RL	5.8	6.6	10	5	0.1	2	2	64
BZX55C6V8RL	6.4	7.2	8	5	0.1	2	3	58
BZX55C7V5RL	7	7.9	7	5	0.1	2	5	53
BZX55C8V2RL	7.7	8.7	7	5	0.1	2	6	47
BZX55C9V1RL	8.5	9.6	10	5	0.1	2	7	43
BZX55C10RL	9.4	10.6	15	5	0.1	2	7.5	40
BZX55C11RL	10.4	11.6	20	5	0.1	2	8.5	36
BZX55C12RL	11.4	12.7	20	5	0.1	2	9	32
BZX55C13RL	12.4	14.1	26	5	0.1	2	10	29
BZX55C15RL	13.8	15.6	30	5	0.1	2	11	27
BZX55C16RL	15.3	17.1	40	5	0.1	2	12	24
BZX55C18RL	16.8	19.1	50	5	0.1	2	14	21
BZX55C20RL	18.8	21.1	55	5	0.1	2	15	20
BZX55C22RL	20.8	23.3	55	5	0.1	2	17	18
BZX55C24RL	22.8	25.6	80	5	0.1	2	18	16
BZX55C27RL	25.1	28.9	80	5	0.1	2	20	14
BZX55C30RL	28	32	80	5	0.1	2	22	13
BZX55C33RL	31	35	80	5	0.1	2	24	12
BZX55C36RL	34	38	80	5	0.1	2	27	11
BZX55C39RL	37	41	90	2.5	0.1	5	28	10
BZX55C43RL	40	46	90	2.5	0.1	5	32	9.2
BZX55C47RL	44	50	110	2.5	0.1	5	35	8.5
BZX55C51RL	48	54	125	2.5	0.1	10	38	7.8
BZX55C56RL	52	60	135	2.5	0.1	10	42	7
BZX55C62RL	58	66	150	2.5	0.1	10	47	6.4
BZX55C68RL	64	72	160	2.5	0.1	10	51	5.9
BZX55C75RL	70	80	170	2.5	0.1	10	56	5.3
BZX55C82RL	77	87	200	2.5	0.1	10	62	4.8
BZX55C91RL	85	96	250	1	0.1	10	69	4.3

**NOTE 1. TOLERANCE AND VOLTAGE DESIGNATION**

Tolerance designation — The type numbers listed have zener voltage min/max limits as shown. Device tolerance of  $\pm 2\%$  are indicated by a "B" instead of a "C". Zener voltage is measured with the device junction in thermal equilibrium at the lead temperature of  $30^\circ\text{C} \pm 1^\circ\text{C}$  and  $3/8"$  lead length.

**NOTE 2.**

This data was calculated using nominal voltages. The maximum current handling capability

on a worst case basis is limited by the actual zener voltage at the operating point and the power derating curve.

**NOTE 3.**

$Z_{ZT}$  and  $Z_{ZK}$  are measured by dividing the ac voltage drop across the device by the ac current applied. The specified limits are for  $I_{Z(ac)} = 0.1 I_{Z(dc)}$  with the ac frequency = 1.0 kHz.

# GENERAL DATA — 500 mW DO-35 GLASS

**\*ELECTRICAL CHARACTERISTICS** ( $T_L = 30^\circ\text{C}$  unless otherwise noted.) ( $V_F = 1.5$  Volts Max @  $I_F = 100$  mAdc for all types.)

Device Type (Note 2)	Zener Voltage (Note 1) (Note 4)			Impedance (Ohm) @ $I_{ZT}$ $f = 1000$ Hz	Leakage Current ( $\mu\text{A}$ )		Temp. Coefficient (Typical) ( $\text{mV}/^\circ\text{C}$ )		Capacitance (Typical) (pF) $V_R = 0$ , $f = 1.0$ MHz
	Min	Max	$I_{ZT} =$ (mA)	Max (Note 3)	Max	@ $V_R =$ (Volt)	Min	Max	
BZX79C2V4RL	2.2	2.6	5	100	100	1	-3.5	0	255
BZX79C2V7RL	2.5	2.9	5	100	75	1	-3.5	0	230
BZX79C3V0RL	2.8	3.2	5	95	50	1	-3.5	0	215
BZX79C3V3RL	3.1	3.5	5	95	25	1	-3.5	0	200
BZX79C3V6RL	3.4	3.8	5	90	15	1	-3.5	0	185
BZX79C3V9RL	3.7	4.1	5	90	10	1	-3.5	+0.3	175
BZX79C4V3RL	4	4.6	5	90	5	1	-3.5	+1	160
BZX79C4V7RL	4.4	5	5	80	3	2	-3.5	+0.2	130
BZX79C5V1RL	4.8	5.4	5	60	2	2	-2.7	+1.2	110
BZX79C5V6RL	5.2	6	5	40	1	2	-2	+2.5	95
BZX79C6V2RL	5.8	6.6	5	10	3	4	0.4	3.7	90
BZX79C6V8RL	6.4	7.2	5	15	2	4	1.2	4.5	85
BZX79C7V5RL	7	7.9	5	15	1	5	2.5	5.3	80
BZX79C8V2RL	7.7	8.7	5	15	0.7	5	3.2	6.2	75
BZX79C9V1RL	8.5	9.6	5	15	0.5	6	3.8	7	70
BZX79C10RL	9.4	10.6	5	20	0.2	7	4.5	8	70
BZX79C11RL	10.4	11.6	5	20	0.1	8	5.4	9	65
BZX79C12RL	11.4	12.7	5	25	0.1	8	6	10	65
BZX79C13RL	12.4	14.1	5	30	0.1	8	7	11	60
BZX79C15RL	13.8	15.6	5	30	0.05	10.5	9.2	13	55
BZX79C16RL	15.3	17.1	5	40	0.05	11.2	10.4	14	52
BZX79C18RL	16.8	19.1	5	45	0.05	12.6	12.9	16	47
BZX79C20RL	18.8	21.2	5	55	0.05	14	14.4	18	36
BZX79C22RL	20.8	23.3	5	55	0.05	15.4	16.4	20	34
BZX79C24RL	22.8	25.6	5	70	0.05	16.8	18.4	22	33
BZX79C27RL	25.1	28.9	2	80	0.05	18.9		23.5	30
BZX79C30RL	28	32	2	80	0.05	21		26	27
BZX79C33RL	31	35	2	80	0.05	23.1		29	25
BZX79C36RL	34	38	2	90	0.05	25.2		31	23
BZX79C39RL	37	41	2	130	0.05	27.3		34	21
BZX79C43RL	40	46	2	150	0.05	30.1		37	21
BZX79C47RL	44	50	2	170	0.05	32.9		40	19
BZX79C51RL	48	54	2	180	0.05	35.7		44	19
BZX79C56RL	52	60	2	200	0.05	39.2		47	18
BZX79C62RL	58	66	2	215	0.05	43.4		51	17
BZX79C68RL	64	72	2	240	0.05	47.6		56	17
BZX79C75RL	70	79	2	255	0.05	52.5		60	16.5
BZX79C82RL	77	87	2	280	0.1	62	46	95	29
BZX79C91RL	85	96	2	300	0.1	69	51	107	28
BZX79C100RL	94	106	1	500	0.1	76	57	119	27
BZX79C110RL	104	116	1	650	0.1	84	63	131	26
BZX79C120RL	114	127	1	800	0.1	91	69	144	24
BZX79C130RL	124	141	1	950	0.1	99	75	158	23
BZX79C150RL	138	156	1	1250	0.1	114	87	185	21
BZX79C160RL	153	171	1	1400	0.1	122	93	200	20
BZX79C180RL	168	191	1	1700	0.1	137	105	228	18
BZX79C200RL	188	212	1	2000	0.1	152	120	255	17

**NOTE 1.** Zener voltage is measured under pulse conditions such that  $T_j$  is no more than  $2^\circ\text{C}$  above  $T_A$ .

**NOTE 2. TOLERANCE AND VOLTAGE DESIGNATION**

Tolerance designation — The type numbers listed have zener voltage min/max limits as

shown. Device tolerances of  $\pm 2\%$  are indicated by a "B" instead of a "C," and  $\pm 1\%$  by "A."

**NOTE 3.**  $Z_{ZT}$  is measured by dividing the ac voltage drop across the device by the ac current applied. The specified limits are for  $I_{Z(ac)} = 0.1 I_{Z(dc)}$  with the ac frequency = 1.0 kHz.

# GENERAL DATA — 500 mW DO-35 GLASS

## ELECTRICAL CHARACTERISTICS (at $T_A = 25^\circ\text{C}$ )

Motorola ZPD and BZX83C series. Forward Voltage  $V_F = 1$  Volt Max at  $I_F = 50$  mA.

Device Type		Zener Voltage (Note 1) at $I_{ZT} = 5.0$ mA			Impedance ( $\Omega$ ) Max (Note 2)			Typ. Temp. Coeff. at $I_{ZT}$ % per $^\circ\text{C}$	$V_R$ Min		
		Nominal	Min	Max	at $I_{ZT}$	at $I_Z = 1$ mA			V		at $I_R$
						BZX83	ZPD		BZX83	ZPD	
BZX83C2V7RL	ZPD2.7RL	2.7	2.5	2.9	85	600	500	-0.09...-0.04	1	—	100 A
BZX83C3V0RL	ZPD3.0RL	3	2.8	3.2	90	600	500	-0.09...-0.03	1	—	60 A
BZX83C3V3RL	ZPD3.3RL	3.3	3.1	3.5	90	600	500	-0.08...-0.03	1	—	30 A
BZX83C3V6RL	ZPD3.6RL	3.6	3.4	3.8	90	600	500	-0.08...-0.03	1	—	20 A
BZX83C3V9RL	ZPD3.9RL	3.9	3.7	4.1	85	600	500	-0.07...-0.03	1	—	10 A
BZX83C4V3RL	ZPD4.3RL	4.3	4	4.6	80	600	500	-0.06...-0.01	1	—	5 A
BZX83C4V7RL	ZPD4.7RL	4.7	4.4	5	78	600	500	-0.05...+0.02	1	—	2 A
BZX83C5V1RL	ZPD5.1RL	5.1	4.8	5.4	60	550	480	-0.03...+0.04	0.8		100 nA
BZX83C5V6RL	ZPD5.6RL	5.6	5.2	6	40	450	400	-0.02...+0.06	1		100 nA
BZX83C6V2RL	ZPD6.2RL	6.2	5.8	6.6	10		200	-0.01...+0.07	2		100 nA
BZX83C6V8RL	ZPD6.8RL	6.8	6.4	7.2	8		150	+0.02...+0.07	3		100 nA
BZX83C7V5RL	ZPD7.5RL	7.5	7	7.9	7		50	+0.03...+0.07	5		100 nA
BZX83C8V2RL	ZPD8.2RL	8.2	7.7	8.7	7		50	+0.04...+0.07	6		100 nA
BZX83C9V1RL	ZPD9.1RL	9.1	8.5	9.6	10		50	+0.05...+0.08	7		100 nA
BZX83C10RL	ZPD10RL	10	9.4	10.6	15		70	+0.05...+0.08	7.5		100 nA
BZX83C11RL	ZPD11RL	11	10.4	11.6	20		70	+0.05...+0.09	8.5		100 nA
BZX83C12RL	ZPD12RL	12	11.4	12.7	20		90	+0.06...+0.09	9		100 nA
BZX83C13RL	ZPD13RL	13	12.4	14.1	25		110	+0.07...+0.09	10		100 nA
BZX83C15RL	ZPD15RL	15	13.8	15.6	30		110	+0.07...+0.09	11		100 nA
BZX83C16RL	ZPD16RL	16	15.3	17.1	40		170	+0.08...+0.095	12		100 nA
BZX83C18RL	ZPD18RL	18	16.8	19.1	50		170	+0.08...+0.10	14		100 nA
BZX83C20RL	ZPD20RL	20	18.8	21.2	55		220	+0.08...+0.10	15		100 nA
BZX83C22RL	ZPD22RL	22	20.8	23.3	55		220	+0.08...+0.10	17		100 nA
BZX83C24RL	ZPD24RL	24	22.8	25.6	80		220	+0.08...+0.10	18		100 nA
BZX83C27RL	ZPD27RL	27	25.1	28.9	80		250	+0.08...+0.10	20		100 nA
BZX83C30RL	ZPD30RL	30	28	32	80		250	+0.08...+0.10	22		100 nA
BZX83C33RL	ZPD33RL	33	31	35	80		250	+0.08...+0.10	24		100 nA

NOTE 1. Pulse test.

NOTE 2.  $f = 1.0$  kHz,  $I_Z(\text{ac}) = 0.1 I_Z(\text{dc})$ .

# GENERAL DATA — 500 mW DO-35 GLASS

Designed for 250 mW applications requiring low leakage, low impedance. Same as 1N4099 through 1N4104 and 1N4614 through 1N4627 except low noise test omitted.

- Voltage Range from 1.8 to 10 Volts
- Zener Impedance and Zener Voltage Specified for Low-Level Operation at  $I_{ZT} = 250 \mu\text{A}$

**ELECTRICAL CHARACTERISTICS** ( $T_A = 25^\circ\text{C}$  unless otherwise specified.  $I_{ZT} = 250 \mu\text{A}$  and  $V_F = 1 \text{ V Max @ } I_F = 200 \text{ mA}$  for all types)

Type Number (Note 1)	Nominal Zener Voltage $V_Z$ (Note 2) (Volts)	Max Zener Impedance $Z_{ZT}$ (Note 3) (Ohms)	Max Reverse Current $I_R$ ( $\mu\text{A}$ ) @ (Note 5)	Test Voltage $V_R$ (Volts)	Max Zener Current $I_{ZM}$ (Note 4) (mA)
MZ4614	1.8	1200	7.5	1	120
MZ4615	2	1250	5	1	110
MZ4616	2.2	1300	4	1	100
MZ4617	2.4	1400	2	1	95
MZ4618	2.7	1500	1	1	90
MZ4619	3	1600	0.8	1	85
MZ4620	3.3	1650	7.5	1.5	80
MZ4621	3.6	1700	7.5	2	75
MZ4622	3.9	1650	5	2	70
MZ4623	4.3	1600	4	2	65
MZ4624	4.7	1550	10	3	60
MZ4625	5.1	1500	10	3	55
MZ4626	5.6	1400	10	4	50
MZ4627	6.2	1200	10	5	45
MZ4099	6.8	200	10	5.2	35
MZ4100	7.5	200	10	5.7	31.8
MZ4101	8.2	200	1	6.3	29
MZ4102	8.7	200	1	6.7	27.4
MZ4103	9.1	200	1	7	26.2
MZ4104	10	200	1	7.6	24.8

**NOTE 1. TOLERANCE AND VOLTAGE DESIGNATION**

The type numbers shown have a standard tolerance of  $\pm 5\%$  on the nominal zener voltage.

**NOTE 2. ZENER VOLTAGE ( $V_Z$ ) MEASUREMENT**

Nominal Zener Voltage is measured with the device junction in the thermal equilibrium with ambient temperature of  $25^\circ\text{C}$ .

**NOTE 3. ZENER IMPEDANCE ( $Z_{ZT}$ ) DERIVATION**

The zener impedance is derived from the 60 cycle ac voltage, which results when an ac current having an rms value equal to 10% of the dc zener current ( $I_{ZT}$ ) is superimposed on  $I_{ZT}$ .

**NOTE 4. MAXIMUM ZENER CURRENT RATINGS ( $I_{ZM}$ )**

Maximum zener current ratings are based on maximum zener voltage of the individual units.

**NOTE 5. REVERSE LEAKAGE CURRENT  $I_R$**

Reverse leakage currents are guaranteed and are measured at  $V_R$  as shown on the table.

**NOTE 6. SPECIAL SELECTORS AVAILABLE INCLUDE:**

A) Tighter voltage tolerances. Contact your nearest Motorola representative for more information.

# GENERAL DATA — 500 mW DO-35 GLASS

## Low Voltage Avalanche Passivated Silicon Oxide Zener Regulator Diodes

Same as 1N5520B through 1N5530B except low noise test spec omitted.

- Low Maximum Regulation Factor
- Low Zener Impedance
- Low Leakage Current

**ELECTRICAL CHARACTERISTICS** ( $T_A = 25^\circ\text{C}$  unless otherwise specified. Based on dc measurements at thermal equilibrium;  $V_F = 1.1$  Max @  $I_F = 200$  mA for all types.)

Motorola Type No. (Note 1)	Nominal Zener Voltage $V_Z$ @ $I_{ZT}$ Volts (Note 2)	Test Current $I_{ZT}$ mAdc	Max Zener Impedance $Z_{ZT}$ @ $I_{ZT}$ Ohms (Note 3)	Max Reverse Leakage Current		Maximum DC Zener Current $I_{ZM}$ mAdc (Note 5)	Regulation Factor $\Delta V_Z$ Volts (Note 6)	Low $V_Z$ Current $I_{ZL}$ mAdc
				$I_R$ $\mu\text{Adc}$ (Note 4)	$V_R$ - Volts			
MZ5520B	3.9	20	22	1	1	98	0.85	2.0
MZ5521B	4.3	20	18	3	1.5	88	0.75	2.0
MZ5522B	4.7	10	22	2	2	81	0.6	1.0
MZ5523B	5.1	5	26	2	2.5	75	0.65	0.25
MZ5524B	5.6	3	30	2	3.5	68	0.3	0.25
MZ5525B	6.2	1	30	1	5	61	0.2	0.01
MZ5526B	6.8	1	30	1	6.2	56	0.1	0.01
MZ5527B	7.5	1	35	0.5	6.8	51	0.05	0.01
MZ5528B	8.2	1	40	0.5	7.5	46	0.05	0.01
MZ5529B	9.1	1	45	0.1	8.2	42	0.05	0.01
MZ5530B	10	1	60	0.05	9.1	38	0.1	0.01

**NOTE 1. TOLERANCE AND VOLTAGE DESIGNATION**

The "B" suffix type numbers listed are  $\pm 5\%$  tolerance of nominal  $V_Z$ .

**NOTE 2. ZENER VOLTAGE ( $V_Z$ ) MEASUREMENT**

Nominal zener voltage is measured with the device junction in thermal equilibrium with ambient temperature of  $25^\circ\text{C}$ .

**NOTE 3. ZENER IMPEDANCE ( $Z_Z$ ) DERIVATION**

The zener impedance is derived from the 60 Hz ac voltage, which results when an ac current having an rms value equal to 10% of the dc zener current ( $I_{ZT}$ ) is superimposed on  $I_{ZT}$ .

**NOTE 4. REVERSE LEAKAGE CURRENT  $I_R$**

Reverse leakage currents are guaranteed and are measured at  $V_R$  as shown on the table.

**NOTE 5. MAXIMUM REGULATOR CURRENT ( $I_{ZM}$ )**

The maximum current shown is based on the maximum voltage of a  $\pm 5\%$  type unit, therefore, it applies only to the "B" suffix device. The actual  $I_{ZM}$  for any device may not exceed the value of 400 milliwatts divided by the actual  $V_Z$  of the device.

**NOTE 6. MAXIMUM REGULATION FACTOR ( $\Delta V_Z$ )**

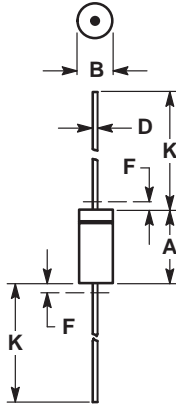
$\Delta V_Z$  is the maximum difference between  $V_Z$  at  $I_{ZT}$  and  $V_Z$  at  $I_{ZL}$  measured with the device junction in thermal equilibrium.

**NOTE 7. SPECIAL SELECTORS AVAILABLE INCLUDE:**

A) Tighter voltage tolerances. Contact your nearest Motorola representative for more information.

# Zener Voltage Regulator Diodes — Axial Leaded

## 500 mW DO-35 Glass



- NOTES:
1. PACKAGE CONTOUR OPTIONAL WITHIN A AND B HEAT SLUGS, IF ANY, SHALL BE INCLUDED WITHIN THIS CYLINDER, BUT NOT SUBJECT TO THE MINIMUM LIMIT OF B.
  2. LEAD DIAMETER NOT CONTROLLED IN ZONE F TO ALLOW FOR FLASH, LEAD FINISH BUILDUP AND MINOR IRREGULARITIES OTHER THAN HEAT SLUGS.
  3. POLARITY DENOTED BY CATHODE BAND.
  4. DIMENSIONING AND TOLERANCING PER ANSI Y14.5M, 1982.

DIM	MILLIMETERS		INCHES	
	MIN	MAX	MIN	MAX
A	3.05	5.08	0.120	0.200
B	1.52	2.29	0.060	0.090
D	0.46	0.56	0.018	0.022
F	—	1.27	—	0.050
K	25.40	38.10	1.000	1.500

All JEDEC dimensions and notes apply.

**CASE 299-02**  
**DO-204AH**  
**GLASS**

(Refer to Section 10 for Surface Mount, Thermal Data and Footprint Information.)

### MULTIPLE PACKAGE QUANTITY (MPQ) REQUIREMENTS

Package Option	Type No. Suffix	MPQ (Units)
Tape and Reel	RL, RL2 <sup>(1)</sup>	5K
Tape and Ammo	TA, TA2 <sup>(1)</sup>	5K

- NOTES: 1. The "2" suffix refers to 26 mm tape spacing.  
2. Radial Tape and Reel may be available. Please contact your Motorola representative.

Refer to Section 10 for more information on Packaging Specifications.

# GENERAL DATA — 500 mW DO-35 GLASS

## 1–1.3 Watt DO-41 Glass Zener Voltage Regulator Diodes GENERAL DATA APPLICABLE TO ALL SERIES IN THIS GROUP One Watt Hermetically Sealed Glass Silicon Zener Diodes

### Specification Features:

- Complete Voltage Range — 3.3 to 100 Volts
- DO-41 Package
- Double Slug Type Construction
- Metallurgically Bonded Construction
- Oxide Passivated Die

### Mechanical Characteristics:

**CASE:** Double slug type, hermetically sealed glass

**MAXIMUM LEAD TEMPERATURE FOR SOLDERING PURPOSES:** 230°C, 1/16" from case for 10 seconds

**FINISH:** All external surfaces are corrosion resistant with readily solderable leads

**POLARITY:** Cathode indicated by color band. When operated in zener mode, cathode will be positive with respect to anode

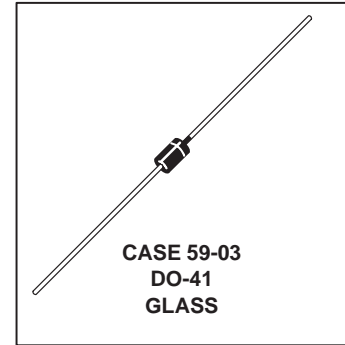
**MOUNTING POSITION:** Any

**WAFER FAB LOCATION:** Phoenix, Arizona

**ASSEMBLY/TEST LOCATION:** Seoul, Korea

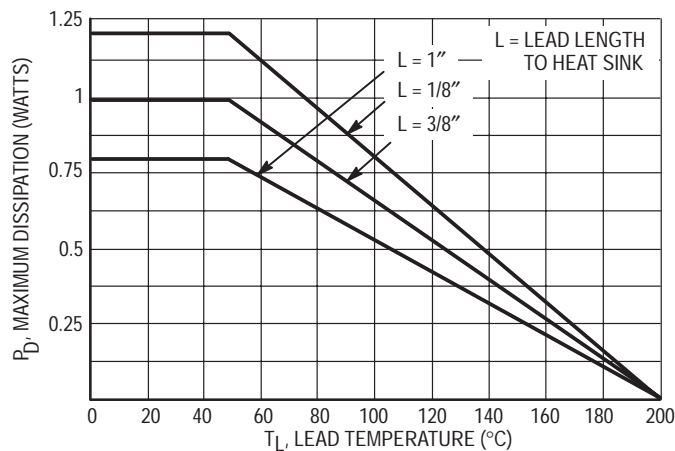
**GENERAL  
DATA  
1–1.3 WATT  
DO-41 GLASS**

**1 WATT  
ZENER REGULATOR  
DIODES  
3.3–100 VOLTS**



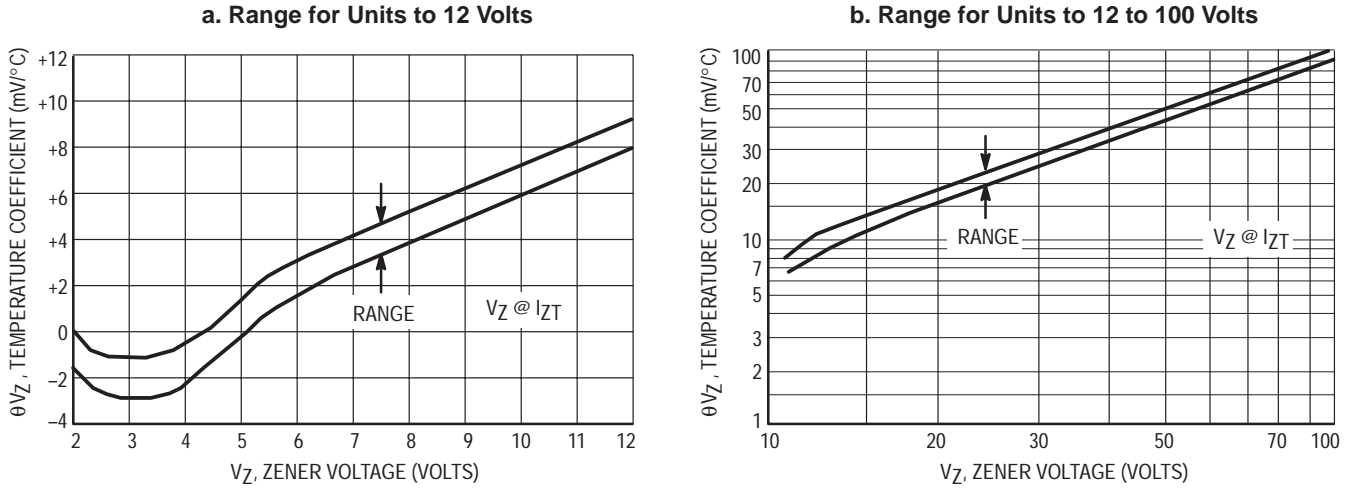
### MAXIMUM RATINGS

Rating	Symbol	Value	Unit
DC Power Dissipation @ $T_A = 50^\circ\text{C}$ Derate above $50^\circ\text{C}$	$P_D$	1 6.67	Watt mW/ $^\circ\text{C}$
Operating and Storage Junction Temperature Range	$T_J, T_{Stg}$	-65 to +200	$^\circ\text{C}$

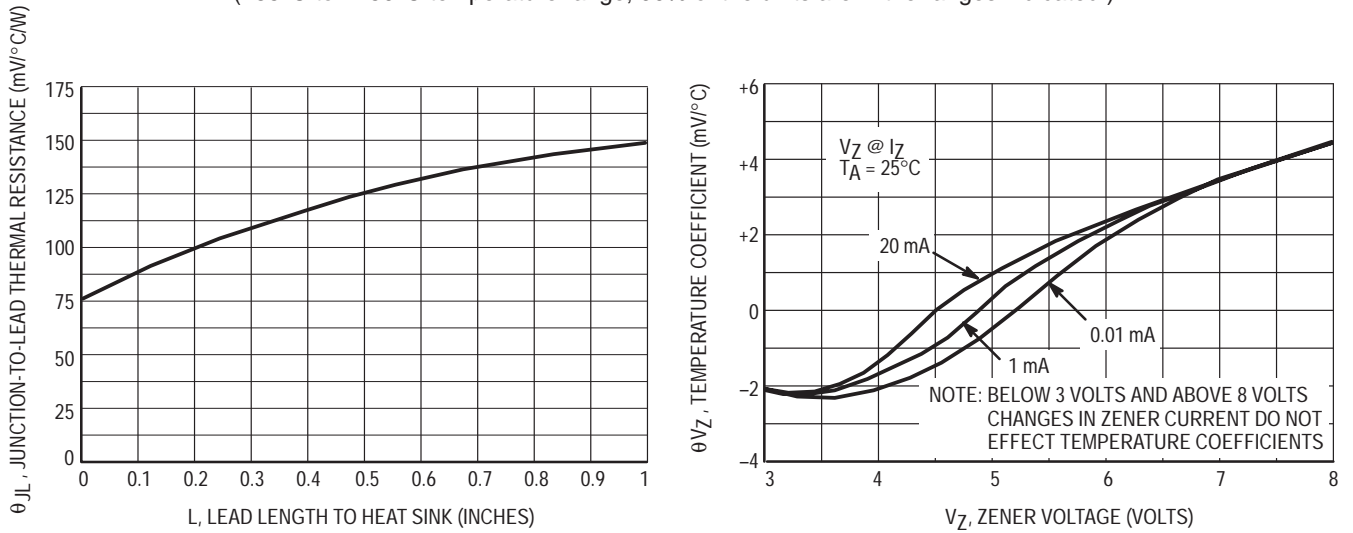


**Figure 1. Power Temperature Derating Curve**

# GENERAL DATA — 500 mW DO-35 GLASS

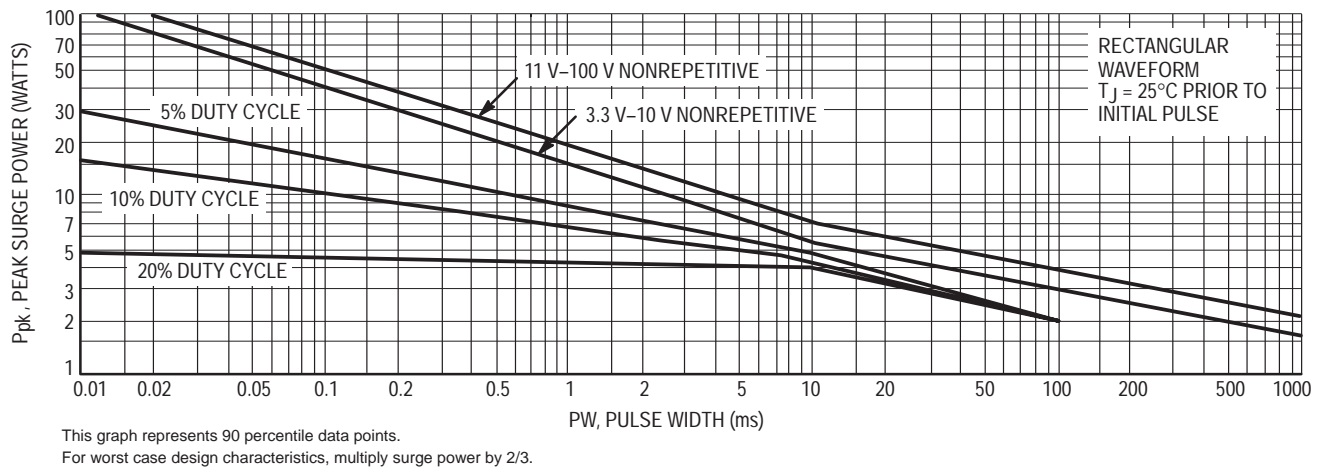


**Figure 2. Temperature Coefficients**  
 (-55°C to +150°C temperature range; 90% of the units are in the ranges indicated.)



**Figure 3. Typical Thermal Resistance versus Lead Length**

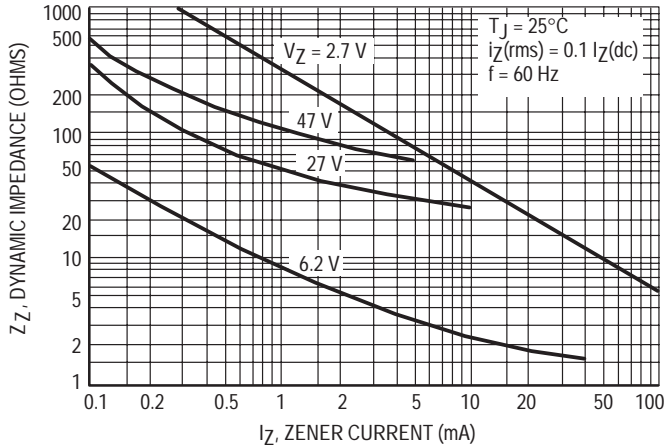
**Figure 4. Effect of Zener Current**



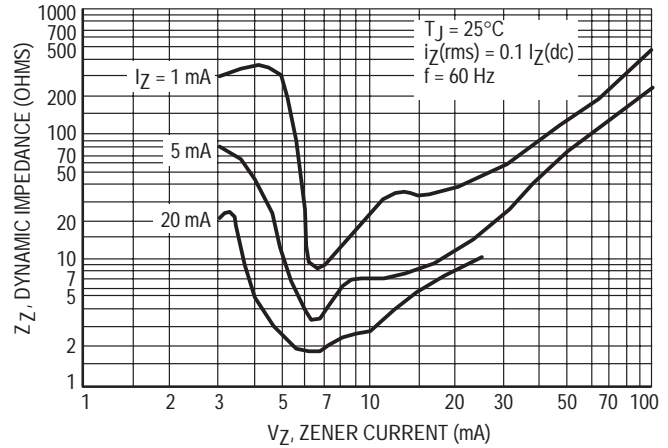
**Figure 5. Maximum Surge Power**



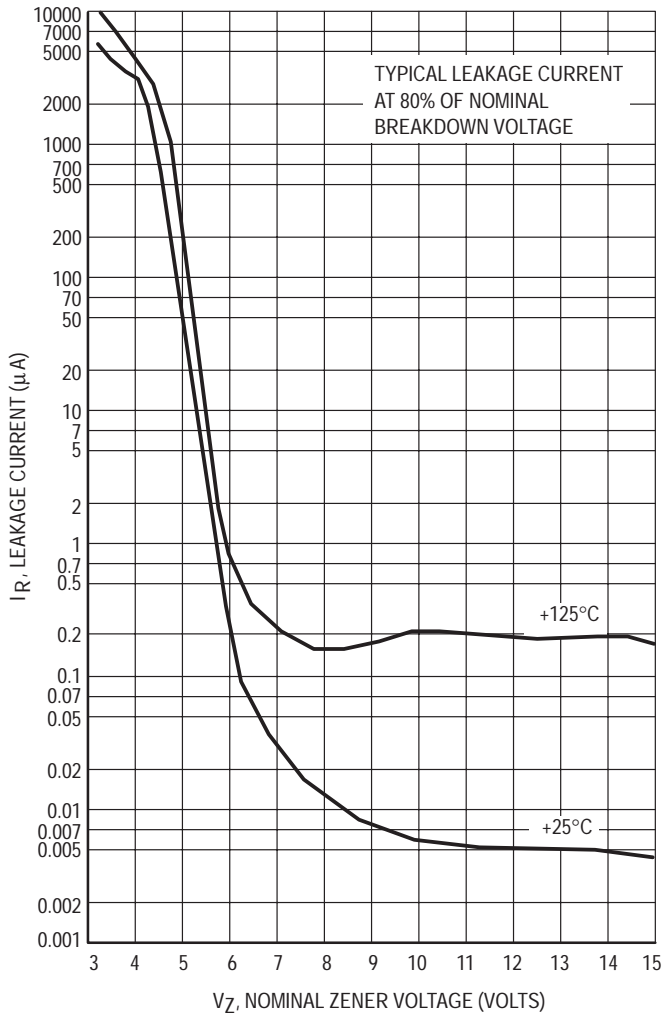
# GENERAL DATA — 500 mW DO-35 GLASS



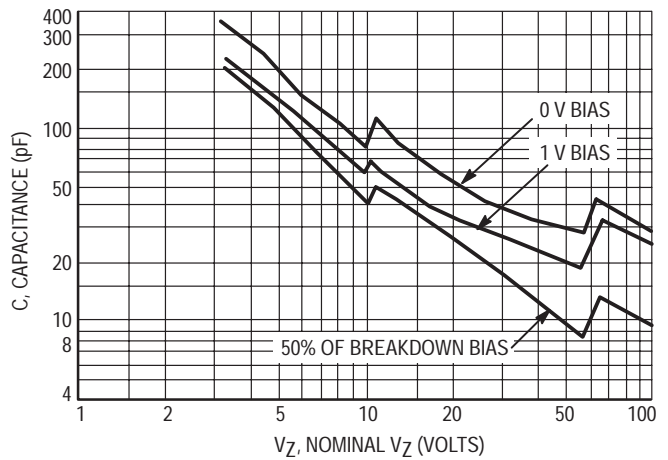
**Figure 6. Effect of Zener Current on Zener Impedance**



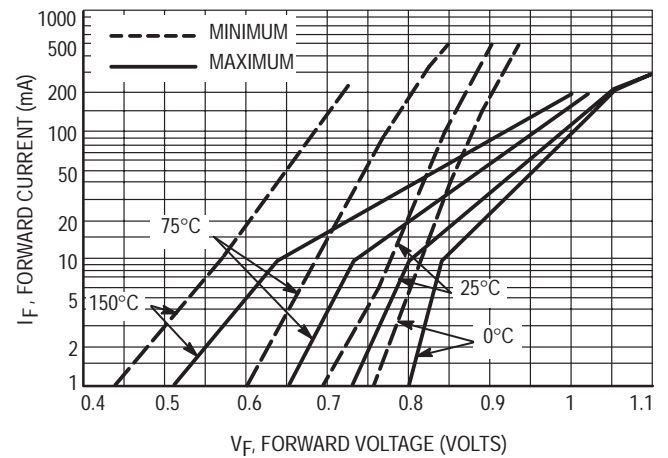
**Figure 7. Effect of Zener Voltage on Zener Impedance**



**Figure 8. Typical Leakage Current**



**Figure 9. Typical Capacitance versus Vz**



**Figure 10. Typical Forward Characteristics**

# GENERAL DATA — 500 mW DO-35 GLASS

## APPLICATION NOTE

Since the actual voltage available from a given zener diode is temperature dependent, it is necessary to determine junction temperature under any set of operating conditions in order to calculate its value. The following procedure is recommended:

Lead Temperature,  $T_L$ , should be determined from:

$$T_L = \theta_{LA} P_D + T_A.$$

$\theta_{LA}$  is the lead-to-ambient thermal resistance ( $^{\circ}\text{C}/\text{W}$ ) and  $P_D$  is the power dissipation. The value for  $\theta_{LA}$  will vary and depends on the device mounting method.  $\theta_{LA}$  is generally 30 to 40  $^{\circ}\text{C}/\text{W}$  for the various clips and tie points in common use and for printed circuit board wiring.

The temperature of the lead can also be measured using a thermocouple placed on the lead as close as possible to the tie point. The thermal mass connected to the tie point is normally large enough so that it will not significantly respond to heat surges generated in the diode as a result of pulsed operation once steady-state conditions are achieved. Using the measured value of  $T_L$ , the junction temperature may be determined by:

$$T_J = T_L + \Delta T_{JL}.$$

$\Delta T_{JL}$  is the increase in junction temperature above the lead

temperature and may be found as follows:

$$\Delta T_{JL} = \theta_{JL} P_D.$$

$\theta_{JL}$  may be determined from Figure 3 for dc power conditions. For worst-case design, using expected limits of  $I_Z$ , limits of  $P_D$  and the extremes of  $T_J(\Delta T_J)$  may be estimated. Changes in voltage,  $V_Z$ , can then be found from:

$$\Delta V = \theta_{VZ} \Delta T_J.$$

$\theta_{VZ}$ , the zener voltage temperature coefficient, is found from Figure 2.

Under high power-pulse operation, the zener voltage will vary with time and may also be affected significantly by the zener resistance. For best regulation, keep current excursions as low as possible.

Surge limitations are given in Figure 5. They are lower than would be expected by considering only junction temperature, as current crowding effects cause temperatures to be extremely high in small spots, resulting in device degradation should the limits of Figure 5 be exceeded.

# GENERAL DATA — 500 mW DO-35 GLASS

\*ELECTRICAL CHARACTERISTICS ( $T_A = 25^\circ\text{C}$  unless otherwise noted)  $V_F = 1.2\text{ V Max}$ ,  $I_F = 200\text{ mA}$  for all types.

JEDEC Type No. (Note 1)	Nominal Zener Voltage $V_Z @ I_{ZT}$ Volts (Notes 2 and 3)	Test Current $I_{ZT}$ mA	Maximum Zener Impedance (Note 4)			Leakage Current		Surge Current @ $T_A = 25^\circ\text{C}$ $i_r - \text{mA}$ (Note 5)
			$Z_{ZT} @ I_{ZT}$ Ohms	$Z_{ZK} @ I_{ZK}$ Ohms	$I_{ZK}$ mA	$I_R$ $\mu\text{A Max}$	$V_R$ Volts	
1N4728A	3.3	76	10	400	1	100	1	1380
1N4729A	3.6	69	10	400	1	100	1	1260
1N4730A	3.9	64	9	400	1	50	1	1190
1N4731A	4.3	58	9	400	1	10	1	1070
1N4732A	4.7	53	8	500	1	10	1	970
<b>1N4733A</b>	<b>5.1</b>	<b>49</b>	<b>7</b>	<b>550</b>	<b>1</b>	<b>10</b>	<b>1</b>	<b>890</b>
<b>1N4734A</b>	<b>5.6</b>	<b>45</b>	<b>5</b>	<b>600</b>	<b>1</b>	<b>10</b>	<b>2</b>	<b>810</b>
<b>1N4735A</b>	<b>6.2</b>	<b>41</b>	<b>2</b>	<b>700</b>	<b>1</b>	<b>10</b>	<b>3</b>	<b>730</b>
<b>1N4736A</b>	<b>6.8</b>	<b>37</b>	<b>3.5</b>	<b>700</b>	<b>1</b>	<b>10</b>	<b>4</b>	<b>660</b>
1N4737A	7.5	34	4	700	0.5	10	5	605
<b>1N4738A</b>	<b>8.2</b>	<b>31</b>	<b>4.5</b>	<b>700</b>	<b>0.5</b>	<b>10</b>	<b>6</b>	<b>550</b>
1N4739A	9.1	28	5	700	0.5	10	7	500
<b>1N4740A</b>	<b>10</b>	<b>25</b>	<b>7</b>	<b>700</b>	<b>0.25</b>	<b>10</b>	<b>7.6</b>	<b>454</b>
<b>1N4741A</b>	<b>11</b>	<b>23</b>	<b>8</b>	<b>700</b>	<b>0.25</b>	<b>5</b>	<b>8.4</b>	<b>414</b>
<b>1N4742A</b>	<b>12</b>	<b>21</b>	<b>9</b>	<b>700</b>	<b>0.25</b>	<b>5</b>	<b>9.1</b>	<b>380</b>
1N4743A	13	19	10	700	0.25	5	9.9	344
<b>1N4744A</b>	<b>15</b>	<b>17</b>	<b>14</b>	<b>700</b>	<b>0.25</b>	<b>5</b>	<b>11.4</b>	<b>304</b>
<b>1N4745A</b>	<b>16</b>	<b>15.5</b>	<b>16</b>	<b>700</b>	<b>0.25</b>	<b>5</b>	<b>12.2</b>	<b>285</b>
<b>1N4746A</b>	<b>18</b>	<b>14</b>	<b>20</b>	<b>750</b>	<b>0.25</b>	<b>5</b>	<b>13.7</b>	<b>250</b>
<b>1N4747A</b>	<b>20</b>	<b>12.5</b>	<b>22</b>	<b>750</b>	<b>0.25</b>	<b>5</b>	<b>15.2</b>	<b>225</b>
<b>1N4748A</b>	<b>22</b>	<b>11.5</b>	<b>23</b>	<b>750</b>	<b>0.25</b>	<b>5</b>	<b>16.7</b>	<b>205</b>
<b>1N4749A</b>	<b>24</b>	<b>10.5</b>	<b>25</b>	<b>750</b>	<b>0.25</b>	<b>5</b>	<b>18.2</b>	<b>190</b>
<b>1N4750A</b>	<b>27</b>	<b>9.5</b>	<b>35</b>	<b>750</b>	<b>0.25</b>	<b>5</b>	<b>20.6</b>	<b>170</b>
<b>1N4751A</b>	<b>30</b>	<b>8.5</b>	<b>40</b>	<b>1000</b>	<b>0.25</b>	<b>5</b>	<b>22.8</b>	<b>150</b>
<b>1N4752A</b>	<b>33</b>	<b>7.5</b>	<b>45</b>	<b>1000</b>	<b>0.25</b>	<b>5</b>	<b>25.1</b>	<b>135</b>
1N4753A	36	7	50	1000	0.25	5	27.4	125
1N4754A	39	6.5	60	1000	0.25	5	29.7	115
1N4755A	43	6	70	1500	0.25	5	32.7	110
1N4756A	47	5.5	80	1500	0.25	5	35.8	95
1N4757A	51	5	95	1500	0.25	5	38.8	90
1N4758A	56	4.5	110	2000	0.25	5	42.6	80
1N4759A	62	4	125	2000	0.25	5	47.1	70
1N4760A	68	3.7	150	2000	0.25	5	51.7	65
1N4761A	75	3.3	175	2000	0.25	5	56	60
1N4762A	82	3	200	3000	0.25	5	62.2	55
1N4763A	91	2.8	250	3000	0.25	5	69.2	50
1N4764A	100	2.5	350	3000	0.25	5	76	45

\*Indicates JEDEC Registered Data.

#### NOTE 1. TOLERANCE AND TYPE NUMBER DESIGNATION

The JEDEC type numbers listed have a standard tolerance on the nominal zener voltage of  $\pm 5\%$ . C for  $\pm 2\%$ , D for  $\pm 1\%$ .

#### NOTE 2. SPECIALS AVAILABLE INCLUDE:

Nominal zener voltages between the voltages shown and tighter voltage tolerances.

For detailed information on price, availability, and delivery, contact your nearest Motorola representative.

#### NOTE 3. ZENER VOLTAGE ( $V_Z$ ) MEASUREMENT

Motorola guarantees the zener voltage when measured at 90 seconds while maintaining the lead temperature ( $T_L$ ) at  $30^\circ\text{C} \pm 1^\circ\text{C}$ , 3/8" from the diode body.

#### NOTE 4. ZENER IMPEDANCE ( $Z_Z$ ) DERIVATION

The zener impedance is derived from the 60 cycle ac voltage, which results when an ac current having an rms value equal to 10% of the dc zener current ( $I_{ZT}$  or  $I_{ZK}$ ) is superimposed on  $I_{ZT}$  or  $I_{ZK}$ .

#### NOTE 5. SURGE CURRENT ( $i_r$ ) NON-REPETITIVE

The rating listed in the electrical characteristics table is maximum peak, non-repetitive, reverse surge current of 1/2 square wave or equivalent sine wave pulse of 1/120 second duration superimposed on the test current,  $I_{ZT}$ , per JEDEC registration; however, actual device capability is as described in Figure 5 of the General Data — DO-41 Glass.

# GENERAL DATA — 500 mW DO-35 GLASS

**ELECTRICAL CHARACTERISTICS** ( $T_A = 25^\circ\text{C}$  unless otherwise noted.) ( $V_F = 1.2\text{ V Max}$ ,  $I_F = 200\text{ mA}$  for all types.)

Type (Note 1)	Zener Voltage $V_{ZT}$ (V) (Notes 2 and 3)		Test Current $I_{ZT}$ (mA)	Zener Impedance $Z_Z$ (ohms) (Note 4)			Leakage Current ( $\mu\text{A}$ )		Surge Current $T_A = 25^\circ\text{C}$ $i_r$ (mA) (Note 5)
	$V_Z$ Min	$V_Z$ Max		Max at $I_{ZT}$	Max at $I_Z$ (mA)		$V_R$ (V)	$I_R$ Max	
BZX85C3V3RL	3.1	3.5	80	20	400	1	1	60	1380
BZX85C3V6RL	3.4	3.8	60	15	500	1	1	30	1260
BZX85C3V9RL	3.7	4.1	60	15	500	1	1	5	1190
BZX85C4V3RL	4	4.6	50	13	500	1	1	3	1070
BZX85C4V7RL	4.4	5	45	13	600	1	1.5	3	970
BZX85C5V1RL	4.8	5.4	45	10	500	1	2	1	890
BZX85C5V6RL	5.2	6	45	7	400	1	2	1	810
BZX85C6V2RL	5.8	6.6	35	4	300	1	3	1	730
BZX85C6V8RL	6.4	7.2	35	3.5	300	1	4	1	660
BZX85C7V5RL	7	7.9	35	3	200	0.5	4.5	1	605
BZX85C8V2RL	7.7	8.7	25	5	200	0.5	5	1	550
BZX85C9V1RL	8.5	9.6	25	5	200	0.5	6.5	1	500
BZX85C10RL	9.4	10.6	25	7	200	0.5	7	0.5	454
BZX85C11RL	10.4	11.6	20	8	300	0.5	7.7	0.5	414
BZX85C12RL	11.4	12.7	20	9	350	0.5	8.4	0.5	380
BZX85C13RL	12.4	14.1	20	10	400	0.5	9.1	0.5	344
BZX85C15RL	13.8	15.6	15	15	500	0.5	10.5	0.5	304
BZX85C16RL	15.3	17.1	15	15	500	0.5	11	0.5	285
BZX85C18RL	16.8	19.1	15	20	500	0.5	12.5	0.5	250
BZX85C20RL	18.8	21.2	10	24	600	0.5	14	0.5	225
BZX85C22RL	20.8	23.3	10	25	600	0.5	15.5	0.5	205
BZX85C24RL	22.8	25.6	10	25	600	0.5	17	0.5	190
BZX85C27RL	25.1	28.9	8	30	750	0.25	19	0.5	170
BZX85C30RL	28	32	8	30	1000	0.25	21	0.5	150
BZX85C33RL	31	35	8	35	1000	0.25	23	0.5	135
BZX85C36RL	34	38	8	40	1000	0.25	25	0.5	125
BZX85C39RL	37	41	6	45	1000	0.25	27	0.5	115
BZX85C43RL	40	46	6	50	1000	0.25	30	0.5	110
BZX85C47RL	44	50	4	90	1500	0.25	33	0.5	95
BZX85C51RL	48	54	4	115	1500	0.25	36	0.5	90
BZX85C56RL	52	60	4	120	2000	0.25	39	0.5	80
BZX85C62RL	58	66	4	125	2000	0.25	43	0.5	70
BZX85C68RL	64	72	4	130	2000	0.25	47	0.5	65
BZX85C75RL	70	80	4	150	2000	0.25	51	0.5	60
BZX85C82RL	77	87	2.7	200	3000	0.25	56	0.5	55
BZX85C91RL	85	96	2.7	250	3000	0.25	62	0.5	50
BZX85C100RL	96	106	2.7	350	3000	0.25	68	0.5	45

**NOTE 1. TOLERANCE AND TYPE NUMBER DESIGNATION**

The type numbers listed have zener voltage min/max limits as shown. Device tolerance of  $\pm 2\%$  are indicated by a "B" instead of "C."

**NOTE 2. SPECIALS AVAILABLE INCLUDE:**

Nominal zener voltages between the voltages shown and tighter voltage tolerances.

For detailed information on price, availability, and delivery, contact your nearest Motorola representative.

**NOTE 3. ZENER VOLTAGE ( $V_Z$ ) MEASUREMENT**

$V_Z$  is measured after the test current has been applied to  $40 \pm 10$  msec., while maintaining the lead temperature ( $T_L$ ) at  $30^\circ\text{C} \pm 1^\circ\text{C}$ ,  $3/8"$  from the diode body.

**NOTE 4. ZENER IMPEDANCE ( $Z_Z$ ) DERIVATION**

The zener impedance is derived from the 1 kHz cycle ac voltage, which results when an ac current having an rms value equal to 10% of the dc zener current ( $I_{ZT}$ ) or ( $I_{ZK}$ ) is superimposed on  $I_{ZT}$  or  $I_{ZK}$ .

**NOTE 5. SURGE CURRENT ( $i_r$ ) NON-REPETITIVE**

The rating listed in the electrical characteristics table is maximum peak, non-repetitive, reverse surge current of 1/2 square wave or equivalent sine wave pulse of 1/120 second duration superimposed on the test current  $I_{ZT}$ . However, actual device capability is as described in Figure 5 of General Data DO-41 glass.

# GENERAL DATA — 500 mW DO-35 GLASS

**ELECTRICAL CHARACTERISTICS** ( $T_A = 25^\circ\text{C}$  unless otherwise noted)  $V_F = 1.2\text{ V Max}$ ,  $I_F = 200\text{ mA}$  for all types.

Type No. (Note 1)	Zener Voltage (V) (Notes 2 and 3)		Test Current $I_{ZT}$ (mA)	Zener Impedance (Note 4) $f = 1\text{ kHz (ohms)}$		Blocking Volt Min (V) $I_R = 1\ \mu\text{A}$	Surge Current $T_A = 25^\circ\text{C}$ $i_r$ (mA) (Note 5)
	$V_Z$ Min	$V_Z$ Max		Typ	Max		
MZPY3.9RL	3.7	4.1	100	4	7	—	1190
MZPY4.3RL	4	4.6	100	4	7	—	1070
MZPY4.7RL	4.4	5	100	4	7	—	970
MZPY5.1RL	4.8	5.4	100	2	5	0.7	890
MZPY5.6RL	5.2	6	100	1	2	1.5	810
MZPY6.2RL	5.8	6.6	100	1	2	2	730
MZPY6.8RL	6.4	7.2	100	1	2	3	660
MZPY7.5RL	7	7.9	100	1	2	5	605
MZPY8.2RL	7.7	8.7	100	1	2	6	550
MZPY9.1RL	8.5	9.6	50	2	4	7	500
MZPY10RL	9.4	10.6	50	2	4	7.5	454
MZPY11RL	10.4	11.6	50	3	7	8.5	414
MZPY12RL	11.4	12.7	50	3	7	9	380
MZPY13RL	12.4	14.1	50	4	9	10	344
MZPY15RL	14.2	15.8	50	4	9	11	304
MZPY16RL	15.3	17.1	25	5	10	12	285
MZPY18RL	16.8	19.1	25	5	11	14	250
MZPY20RL	18.8	21.2	25	6	12	15	225
MZPY22RL	20.8	23.3	25	7	13	17	205
MZPY24RL	22.8	25.6	25	8	14	18	190
MZPY27RL	25.1	28.9	25	9	15	20	170
MZPY30RL	28	32	25	10	20	22.5	150
MZPY33RL	31	35	25	11	20	25	135
MZPY36RL	34	38	10	25	60	27	125
MZPY39RL	37	41	10	30	60	29	115
MZPY43RL	40	46	10	35	80	32	110
MZPY47RL	44	50	10	40	80	35	95
MZPY51RL	48	54	10	45	100	38	90
MZPY56RL	52	60	10	50	100	42	80
MZPY62RL	58	66	10	60	130	47	70
MZPY68RL	64	72	10	65	130	51	65
MZPY75RL	70	79	10	70	160	56	60
MZPY82RL	77	88	10	80	160	61	55
MZPY91RL	85	96	5	120	250	68	50
MZPY100RL	94	106	5	130	250	75	45

**NOTE 1. TOLERANCE AND TYPE NUMBER DESIGNATION**

The type numbers listed have zener voltage min/max limits as shown. Device tolerance of  $\pm 2\%$  are indicated by a "C" and  $\pm 1\%$  by a "D" suffix.

**NOTE 2. SPECIALS AVAILABLE INCLUDE:**

Nominal zener voltages between the voltages shown and tighter voltage tolerances. For detailed information on price, availability, and delivery, contact your nearest Motorola representative.

**NOTE 3. ZENER VOLTAGE ( $V_Z$ ) MEASUREMENT**

$V_Z$  is measured after the test current has been applied to  $40 \pm 10$  msec., while maintaining the lead temperature ( $T_L$ ) at  $30^\circ\text{C} \pm 1^\circ\text{C}$ ,  $3/8"$  from the diode body.

**NOTE 4. ZENER IMPEDANCE ( $Z_Z$ ) DERIVATION**

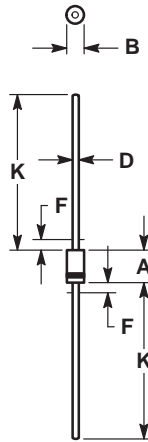
The zener impedance is derived from the 1 kHz cycle ac voltage, which results when an ac current having an rms value equal to 10% of the dc zener current ( $I_{ZT}$ ) of ( $I_{ZK}$ ) is superimposed on  $I_{ZT}$  or  $I_{ZK}$ .

**NOTE 5. SURGE CURRENT ( $i_r$ ) NON-REPETITIVE**

The rating listed in the electrical characteristics table is maximum peak, non-repetitive, reverse surge current of 1/2 square wave or equivalent sine wave pulse of 1/120 second duration superimposed on the test current  $I_{ZT}$ , however, actual device capability is as described in Figure 5 of General Data DO-41 glass.

# Zener Voltage Regulator Diodes — Axial Ledged

## 1–1.3 Watt DO-41 Glass



- NOTES:
1. ALL RULES AND NOTES ASSOCIATED WITH JEDEC DO-41 OUTLINE SHALL APPLY.
  2. POLARITY DENOTED BY CATHODE BAND.
  3. LEAD DIAMETER NOT CONTROLLED WITHIN F DIMENSION.

DIM	MILLIMETERS		INCHES	
	MIN	MAX	MIN	MAX
A	4.07	5.20	0.160	0.205
B	2.04	2.71	0.080	0.107
D	0.71	0.86	0.028	0.034
F	—	1.27	—	0.050
K	27.94	—	1.100	—

**CASE 59-03  
DO-41  
GLASS**

(Refer to Section 10 for Surface Mount, Thermal Data and Footprint Information.)

### MULTIPLE PACKAGE QUANTITY (MPQ) REQUIREMENTS

Package Option	Type No. Suffix	MPQ (Units)
Tape and Reel	RL, RL2	6K
Tape and Ammo	TA, TA2	4K

NOTE: 1. The "2" suffix refers to 26 mm tape spacing.

(Refer to Section 10 for more information on Packaging Specifications.)

# GENERAL DATA — 500 mW DO-35 GLASS

## 1 to 3 Watt DO-41 Surmetic 30 Zener Voltage Regulator Diodes GENERAL DATA APPLICABLE TO ALL SERIES IN THIS GROUP 1 to 3 Watt Surmetic 30 Silicon Zener Diodes

... a complete series of 1 to 3 Watt Zener Diodes with limits and operating characteristics that reflect the superior capabilities of silicon-oxide-passivated junctions. All this in an axial-lead, transfer-molded plastic package offering protection in all common environmental conditions.

### Specification Features:

- Surge Rating of 98 Watts @ 1 ms
- Maximum Limits Guaranteed On Up To Six Electrical Parameters
- Package No Larger Than the Conventional 1 Watt Package

### Mechanical Characteristics:

**CASE:** Void-free, transfer-molded, thermosetting plastic

**FINISH:** All external surfaces are corrosion resistant and leads are readily solderable

**POLARITY:** Cathode indicated by color band. When operated in zener mode, cathode will be positive with respect to anode

**MOUNTING POSITION:** Any

**WEIGHT:** 0.4 gram (approx)

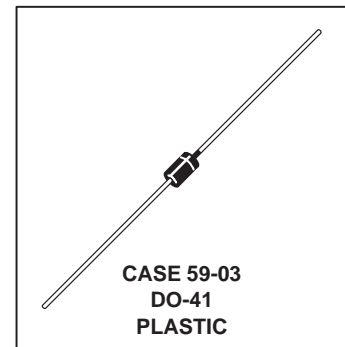
**WAFER FAB LOCATION:** Phoenix, Arizona

**ASSEMBLY/TEST LOCATION:** Seoul, Korea

## GENERAL DATA

### 1-3 WATT DO-41 SURMETIC 30

### 1 TO 3 WATT ZENER REGULATOR DIODES 3.3-400 VOLTS



### MAXIMUM RATINGS

Rating	Symbol	Value	Unit
DC Power Dissipation @ $T_L = 75^\circ\text{C}$ Lead Length = 3/8" Derate above $75^\circ\text{C}$	$P_D$	3	Watts
		24	mW/ $^\circ\text{C}$
DC Power Dissipation @ $T_A = 50^\circ\text{C}$ Derate above $50^\circ\text{C}$	$P_D$	1	Watt
		6.67	mW/ $^\circ\text{C}$
Operating and Storage Junction Temperature Range	$T_J, T_{stg}$	- 65 to +200	$^\circ\text{C}$

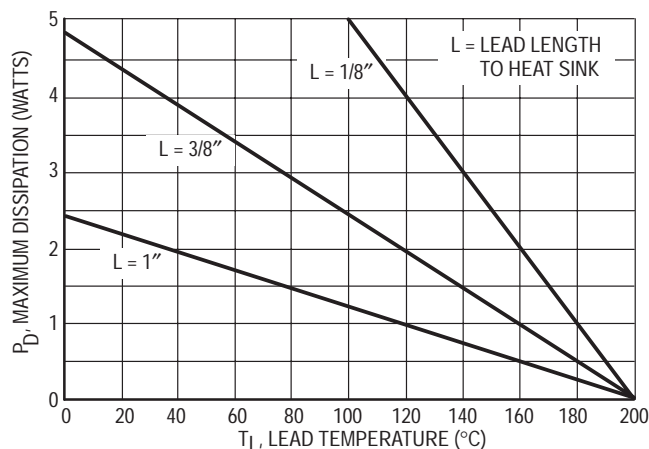


Figure 1. Power Temperature Derating Curve

# GENERAL DATA — 500 mW DO-35 GLASS

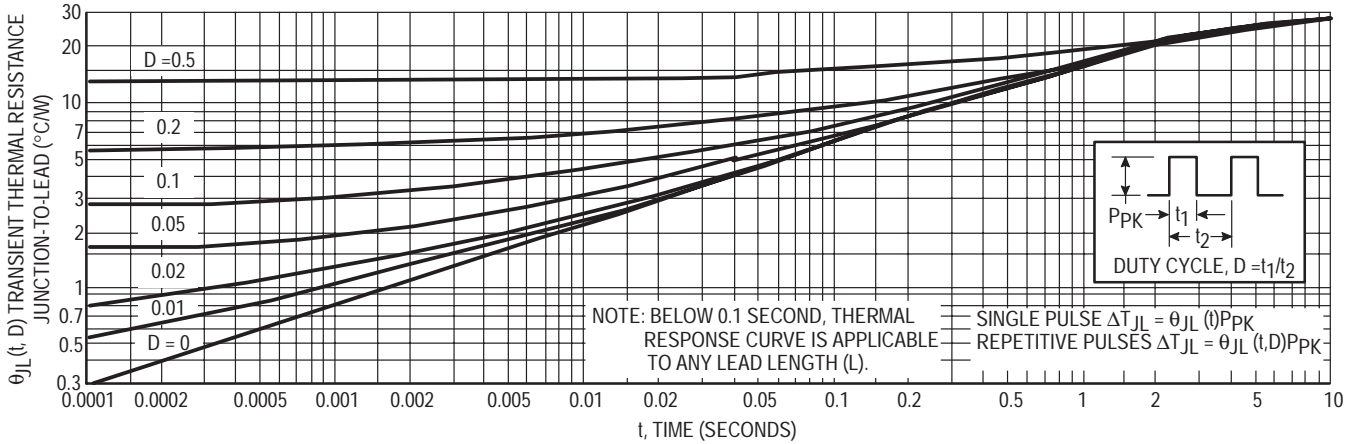


Figure 2. Typical Thermal Response L, Lead Length = 3/8 Inch

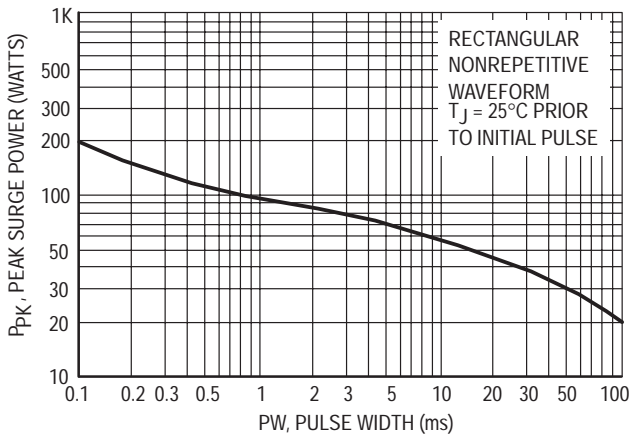


Figure 3. Maximum Surge Power

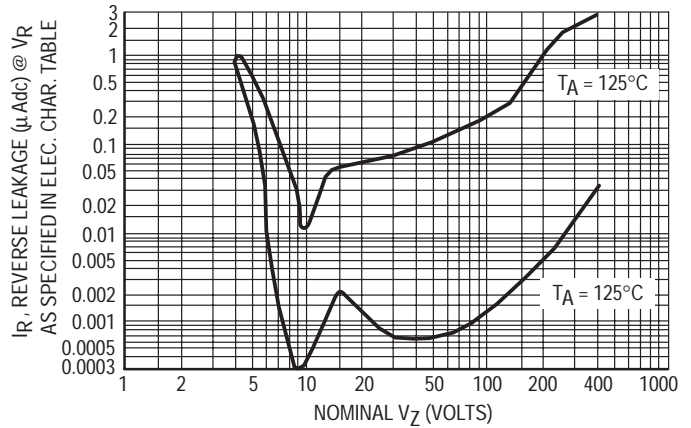


Figure 4. Typical Reverse Leakage

## APPLICATION NOTE

Since the actual voltage available from a given zener diode is temperature dependent, it is necessary to determine junction temperature under any set of operating conditions in order to calculate its value. The following procedure is recommended:

Lead Temperature,  $T_L$ , should be determined from:

$$T_L = \theta_{LA} P_D + T_A$$

$\theta_{LA}$  is the lead-to-ambient thermal resistance ( $^{\circ}\text{C}/\text{W}$ ) and  $P_D$  is the power dissipation. The value for  $\theta_{LA}$  will vary and depends on the device mounting method.  $\theta_{LA}$  is generally  $30\text{--}40^{\circ}\text{C}/\text{W}$  for the various clips and tie points in common use and for printed circuit board wiring.

The temperature of the lead can also be measured using a thermocouple placed on the lead as close as possible to the tie point. The thermal mass connected to the tie point is normally large enough so that it will not significantly respond to heat surges generated in the diode as a result of pulsed operation once steady-state conditions are achieved. Using the measured value of  $T_L$ , the junction temperature may be determined by:

$$T_J = T_L + \Delta T_{JL}$$

$\Delta T_{JL}$  is the increase in junction temperature above the lead temperature and may be found from Figure 2 for a train of power pulses ( $L = 3/8$  inch) or from Figure 10 for dc power.

$$\Delta T_{JL} = \theta_{JL} P_D$$

For worst-case design, using expected limits of  $I_Z$ , limits of  $P_D$  and the extremes of  $T_J$  ( $\Delta T_J$ ) may be estimated. Changes in voltage,  $V_Z$ , can then be found from:

$$\Delta V = \theta_{VZ} \Delta T_J$$

$\theta_{VZ}$ , the zener voltage temperature coefficient, is found from Figures 5 and 6.

Under high power-pulse operation, the zener voltage will vary with time and may also be affected significantly by the zener resistance. For best regulation, keep current excursions as low as possible.

Data of Figure 2 should not be used to compute surge capability. Surge limitations are given in Figure 3. They are lower than would be expected by considering only junction temperature, as current crowding effects cause temperatures to be extremely high in small spots resulting in device degradation should the limits of Figure 3 be exceeded.



# GENERAL DATA — 500 mW DO-35 GLASS

## TEMPERATURE COEFFICIENT RANGES

(90% of the Units are in the Ranges Indicated)

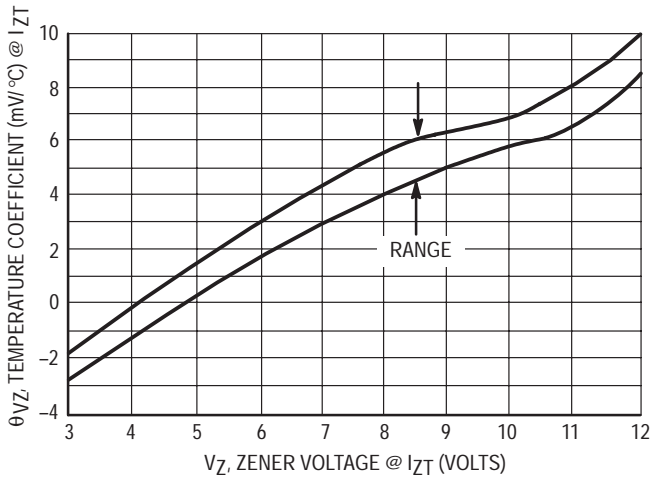


Figure 5. Units To 12 Volts

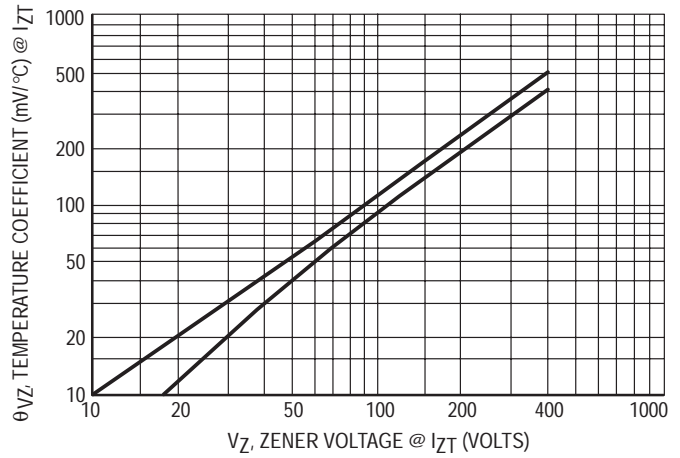


Figure 6. Units 10 To 400 Volts

## ZENER VOLTAGE versus ZENER CURRENT

(Figures 7, 8 and 9)

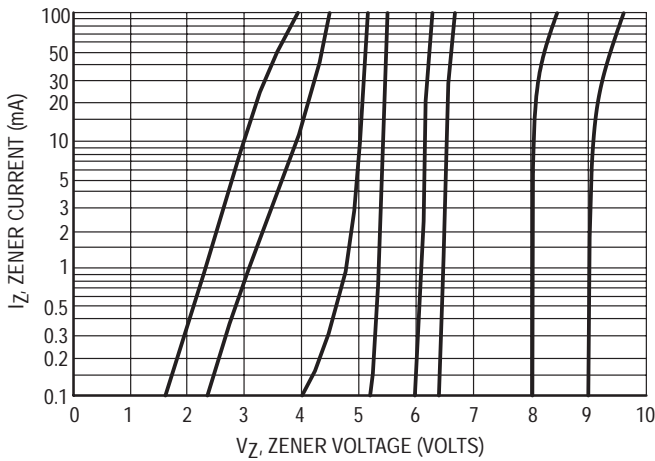


Figure 7.  $V_Z = 3.3$  thru 10 Volts

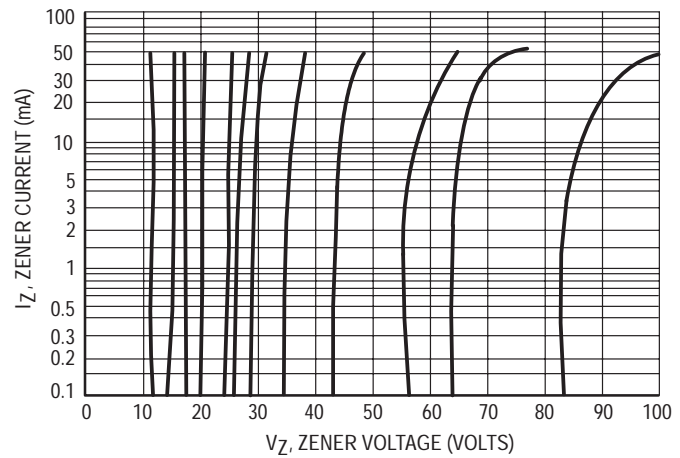


Figure 8.  $V_Z = 12$  thru 82 Volts

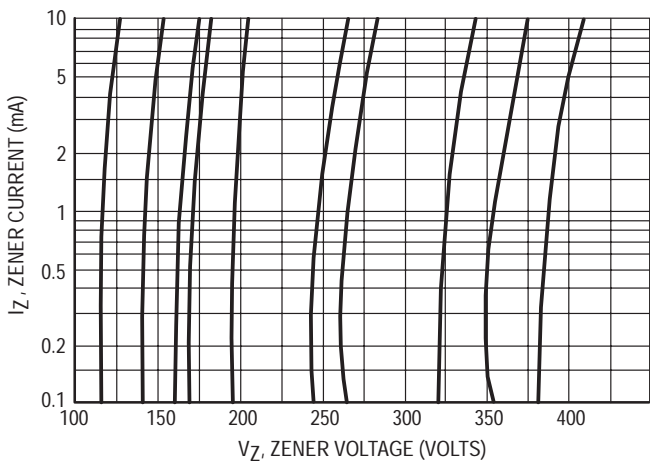


Figure 9.  $V_Z = 100$  thru 400 Volts

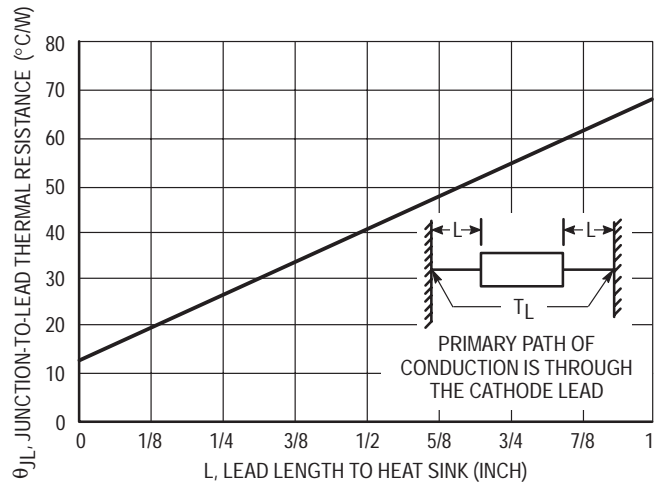


Figure 10. Typical Thermal Resistance

# GENERAL DATA — 500 mW DO-35 GLASS

## \*MAXIMUM RATINGS

Rating	Symbol	Value	Unit
DC Power Dissipation @ $T_L = 75^\circ\text{C}$ , Lead Length = 3/8"	$P_D$	1.5	Watts
Derate above $75^\circ\text{C}$		12	mW/ $^\circ\text{C}$

## \*ELECTRICAL CHARACTERISTICS ( $T_L = 30^\circ\text{C}$ unless otherwise noted. $V_F = 1.5$ Volts Max @ $I_F = 200$ mAdc for all types.)

Motorola Type Number (Note 1)	Nominal Zener Voltage $V_Z$ @ $I_{ZT}$ Volts (Note 2 and 3)	Test Current $I_{ZT}$ mA	Max. Zener Impedance (Note 4)			Max. Reverse Leakage Current		Maximum DC Zener Current $I_{ZM}$ mAdc
			$Z_{ZT}$ @ $I_{ZT}$ Ohms	$Z_{ZK}$ Ohms @	$I_{ZK}$ mA	$I_R$ @ $V_R$ $\mu\text{A}$ Volts		
1N5913B	3.3	113.6	10	500	1	100	1	454
1N5914B	3.6	104.2	9	500	1	75	1	416
1N5915B	3.9	96.1	7.5	500	1	25	1	384
1N5916B	4.3	87.2	6	500	1	5	1	348
1N5917B	4.7	79.8	5	500	1	5	1.5	319
<b>1N5918B</b>	<b>5.1</b>	<b>73.5</b>	<b>4</b>	<b>350</b>	<b>1</b>	<b>5</b>	<b>2</b>	<b>294</b>
1N5919B	5.6	66.9	2	250	1	5	3	267
<b>1N5920B</b>	<b>6.2</b>	<b>60.5</b>	<b>2</b>	<b>200</b>	<b>1</b>	<b>5</b>	<b>4</b>	<b>241</b>
1N5921B	6.8	55.1	2.5	200	1	5	5.2	220
1N5922B	7.5	50	3	400	0.5	5	6	200
1N5923B	8.2	45.7	3.5	400	0.5	5	6.5	182
1N5924B	9.1	41.2	4	500	0.5	5	7	164
1N5925B	10	37.5	4.5	500	0.25	5	8	150
1N5926B	11	34.1	5.5	550	0.25	1	8.4	136
1N5927B	12	31.2	6.5	550	0.25	1	9.1	125
1N5928B	13	28.8	7	550	0.25	1	9.9	115
<b>1N5929B</b>	<b>15</b>	<b>25</b>	<b>9</b>	<b>600</b>	<b>0.25</b>	<b>1</b>	<b>11.4</b>	<b>100</b>
1N5930B	16	23.4	10	600	0.25	1	12.2	93
1N5931B	18	20.8	12	650	0.25	1	13.7	83
1N5932B	20	18.7	14	650	0.25	1	15.2	75
1N5933B	22	17	17.5	650	0.25	1	16.7	68
1N5934B	24	15.6	19	700	0.25	1	18.2	62
1N5935B	27	13.9	23	700	0.25	1	20.6	55
<b>1N5936B</b>	<b>30</b>	<b>12.5</b>	<b>26</b>	<b>750</b>	<b>0.25</b>	<b>1</b>	<b>22.8</b>	<b>50</b>
1N5937B	33	11.4	33	800	0.25	1	25.1	45
1N5938B	36	10.4	38	850	0.25	1	27.4	41
1N5939B	39	9.6	45	900	0.25	1	29.7	38
1N5940B	43	8.7	53	950	0.25	1	32.7	34
1N5941B	47	8	67	1000	0.25	1	35.8	31
1N5942B	51	7.3	70	1100	0.25	1	38.8	29
1N5943B	56	6.7	86	1300	0.25	1	42.6	26
1N5944B	62	6	100	1500	0.25	1	47.1	24
1N5945B	68	5.5	120	1700	0.25	1	51.7	22
1N5946B	75	5	140	2000	0.25	1	56	20
1N5947B	82	4.6	160	2500	0.25	1	62.2	18

(continued)

\*Indicates JEDEC Registered Data.

# GENERAL DATA — 500 mW DO-35 GLASS

\*ELECTRICAL CHARACTERISTICS — continued ( $T_L = 30^\circ\text{C}$  unless otherwise noted.  $V_F = 1.5$  Volts Max @  $I_F = 200$  mAdc for all types.)

Motorola Type Number (Note 1)	Nominal Zener Voltage $V_Z$ @ $I_{ZT}$ Volts (Note 2 and 3)	Test Current $I_{ZT}$ mA	Max. Zener Impedance (Note 4)			Max. Reverse Leakage Current		Maximum DC Zener Current $I_{ZM}$ mAdc
			$Z_{ZT}$ @ $I_{ZT}$ Ohms	$Z_{ZK}$ Ohms @	$I_{ZK}$ mA	$I_R$ @ $V_R$ $\mu\text{A}$ Volts		
1N5948B	91	4.1	200	3000	0.25	1	69.2	16
1N5949B	100	3.7	250	3100	0.25	1	76	15
1N5950B	110	3.4	300	4000	0.25	1	83.6	13
1N5951B	120	3.1	380	4500	0.25	1	91.2	12
1N5952B	130	2.9	450	5000	0.25	1	98.8	11
1N5953B	150	2.5	600	6000	0.25	1	114	10
1N5954B	160	2.3	700	6500	0.25	1	121.6	9
<b>1N5955B</b>	<b>180</b>	<b>2.1</b>	<b>900</b>	<b>7000</b>	<b>0.25</b>	<b>1</b>	<b>136.8</b>	<b>8</b>
1N5956B	200	1.9	1200	8000	0.25	1	152	7

\*Indicates JEDEC Registered Data.

#### NOTE 1. TOLERANCE AND VOLTAGE DESIGNATION

Tolerance designation — Device tolerances of  $\pm 5\%$  are indicated by a "B" suffix.

#### NOTE 2. SPECIAL SELECTIONS AVAILABLE INCLUDE:

Nominal zener voltages between those shown and  $\pm 1\%$  and  $\pm 2\%$  tight voltage tolerances. Consult factory.

#### NOTE 3. ZENER VOLTAGE ( $V_Z$ ) MEASUREMENT

Motorola guarantees the zener voltage when measured at 90 seconds while maintaining the lead temperature ( $T_L$ ) at  $30^\circ\text{C} \pm 1^\circ\text{C}$ ,  $3/8"$  from the diode body.

#### NOTE 4. ZENER IMPEDANCE ( $Z_Z$ ) DERIVATION

The zener impedance is derived from the 60 cycle ac voltage, which results when an ac current having an rms value equal to 10% of the dc zener current ( $I_{ZT}$  or  $I_{ZK}$ ) is superimposed on  $I_{ZT}$  or  $I_{ZK}$ .

# GENERAL DATA — 500 mW DO-35 GLASS

**ELECTRICAL CHARACTERISTICS** ( $T_A = 25^\circ\text{C}$  unless otherwise noted)  $V_F = 1.5\text{ V Max}$ ,  $I_F = 200\text{ mA}$  for all types)

Motorola Type No. (Note 1)	Nominal Zener Voltage $V_Z$ @ $I_{ZT}$ Volts (Note 2)	Test Current $I_{ZT}$ mA	Max Zener Impedance (Note 3)			Leakage Current		Maximum Zener Current $I_{ZM}$ mA	Surge Current @ $T_A = 25^\circ\text{C}$ $i_r - \text{mA}$ (Note 4)
			$Z_{ZT}$ @ $I_{ZT}$ Ohms	$Z_{ZK}$ @ $I_{ZK}$ Ohms	$I_{ZK}$ mA	$I_R$ @ $V_R$ $\mu\text{A Max}$ Volts			
3EZ3.9D5 <b>3EZ4.3D5</b>	3.9 <b>4.3</b>	192 <b>174</b>	4.5 <b>4.5</b>	400 <b>400</b>	1 <b>1</b>	80 <b>30</b>	1 <b>1</b>	630 <b>590</b>	4.4 <b>4.1</b>
3EZ4.7D5	4.7	160	4	500	1	20	1	550	3.8
3EZ5.1D5	5.1	147	3.5	550	1	5	1	520	3.5
3EZ5.6D5	5.6	134	2.5	600	1	5	2	480	3.3
3EZ6.2D5	6.2	121	1.5	700	1	5	3	435	3.1
3EZ6.8D5	6.8	110	2	700	1	5	4	393	2.9
3EZ7.5D5	7.5	100	2	700	0.5	5	5	360	2.66
3EZ8.2D5	8.2	91	2.3	700	0.5	5	6	330	2.44
3EZ9.1D5	9.1	82	2.5	700	0.5	3	7	297	2.2
3EZ10D5	10	75	3.5	700	0.25	3	7.6	270	2
3EZ11D5	11	68	4	700	0.25	1	8.4	245	1.82
3EZ12D5	12	63	4.5	700	0.25	1	9.1	225	1.66
3EZ13D5	13	58	4.5	700	0.25	0.5	9.9	208	1.54
3EZ14D5	14	53	5	700	0.25	0.5	10.6	193	1.43
3EZ15D5	15	50	5.5	700	0.25	0.5	11.4	180	1.33
3EZ16D5	16	47	5.5	700	0.25	0.5	12.2	169	1.25
3EZ17D5	17	44	6	750	0.25	0.5	13	159	1.18
3EZ18D5	18	42	6	750	0.25	0.5	13.7	150	1.11
3EZ19D5	19	40	7	750	0.25	0.5	14.4	142	1.05
3EZ20D5	20	37	7	750	0.25	0.5	15.2	135	1
3EZ22D5	22	34	8	750	0.25	0.5	16.7	123	0.91
3EZ24D5	24	31	9	750	0.25	0.5	18.2	112	0.83
3EZ27D5	27	28	10	750	0.25	0.5	20.6	100	0.74
3EZ28D5	28	27	12	750	0.25	0.5	21	96	0.71
3EZ30D5	30	25	16	1000	0.25	0.5	22.5	90	0.67
3EZ33D5	33	23	20	1000	0.25	0.5	25.1	82	0.61
3EZ36D5	36	21	22	1000	0.25	0.5	27.4	75	0.56
3EZ39D5	39	19	28	1000	0.25	0.5	29.7	69	0.51
3EZ43D5	43	17	33	1500	0.25	0.5	32.7	63	0.45
3EZ47D5	47	16	38	1500	0.25	0.5	35.6	57	0.42
3EZ51D5	51	15	45	1500	0.25	0.5	38.8	53	0.39
3EZ56D5	56	13	50	2000	0.25	0.5	42.6	48	0.36
3EZ62D5	62	12	55	2000	0.25	0.5	47.1	44	0.32
3EZ68D5	68	11	70	2000	0.25	0.5	51.7	40	0.29
3EZ75D5	75	10	85	2000	0.25	0.5	56	36	0.27
3EZ82D5	82	9.1	95	3000	0.25	0.5	62.2	33	0.24
3EZ91D5	91	8.2	115	3000	0.25	0.5	69.2	30	0.22
3EZ100D5	100	7.5	160	3000	0.25	0.5	76	27	0.2
3EZ110D5	110	6.8	225	4000	0.25	0.5	83.6	25	0.18
3EZ120D5	120	6.3	300	4500	0.25	0.5	91.2	22	0.16
3EZ130D5	130	5.8	375	5000	0.25	0.5	98.8	21	0.15
3EZ140D5	140	5.3	475	5000	0.25	0.5	106.4	19	0.14
3EZ150D5	150	5	550	6000	0.25	0.5	114	18	0.13
3EZ160D5	160	4.7	625	6500	0.25	0.5	121.6	17	0.12
3EZ170D5	170	4.4	650	7000	0.25	0.5	130.4	16	0.12
3EZ180D5	180	4.2	700	7000	0.25	0.5	136.8	15	0.11
3EZ190D5	190	4	800	8000	0.25	0.5	144.8	14	0.1

(continued)

# GENERAL DATA — 500 mW DO-35 GLASS

**ELECTRICAL CHARACTERISTICS — continued** ( $T_A = 25^\circ\text{C}$  unless otherwise noted)  $V_F = 1.5\text{ V Max}$ ,  $I_F = 200\text{ mA}$  for all types)

Motorola Type No. (Note 1)	Nominal Zener Voltage $V_Z$ @ $I_{ZT}$ Volts (Note 2)	Test Current $I_{ZT}$ mA	Max Zener Impedance (Note 3)			Leakage Current		Maximum Zener Current $I_{ZM}$ mA	Surge Current @ $T_A = 25^\circ\text{C}$ $i_r$ - mA (Note 4)
			$Z_{ZT}$ @ $I_{ZT}$ Ohms	$Z_{ZK}$ @ $I_{ZK}$ Ohms	$I_{ZK}$ mA	$I_R$ @ $V_R$ $\mu\text{A Max}$ Volts			
3EZ200D5	200	3.7	875	8000	0.25	0.5	152	13	0.1
3EZ220D5	220	3.4	1600	9000	0.25	1	167	12	0.09
3EZ240D5	240	3.1	1700	9000	0.25	1	182	11	0.09
3EZ270D5	270	2.8	1800	9000	0.25	1	205	10	0.08
3EZ300D5	300	2.5	1900	9000	0.25	1	228	9	0.07
3EZ330D5	330	2.3	2200	9000	0.25	1	251	8	0.06
3EZ360D5	360	2.1	2700	9000	0.25	1	274	8	0.06
3EZ400D5	400	1.9	3500	9000	0.25	1	304	7	0.06

**NOTE 1. TOLERANCES**

Suffix 5 indicates 5% tolerance. Any other tolerance will be considered as a special device.

**NOTE 2. ZENER VOLTAGE ( $V_Z$ ) MEASUREMENT**

Motorola guarantees the zener voltage when measured at 40 ms  $\pm$  10 ms 3/8" from the diode body, and an ambient temperature of 25°C (+8°C, -2°C)

**NOTE 3. ZENER IMPEDANCE ( $Z_Z$ ) DERIVATION**

The zener impedance is derived from the 60 cycle ac voltage, which results when an ac current having an rms value equal to 10% of the dc zener current ( $I_{ZT}$  or  $I_{ZK}$ ) is superimposed on  $I_{ZT}$  or  $I_{ZK}$ .

**NOTE 4. SURGE CURRENT ( $i_r$ ) NON-REPETITIVE**

The rating listed in the electrical characteristics table is maximum peak, non-repetitive, reverse surge current of 1/2 square wave or equivalent sine wave pulse of 1/120 second duration superimposed on the test current,  $I_{ZT}$ , per JEDEC standards, however, actual device capability is as described in Figure 3 of General Data sheet for Surmetic 30s.

**NOTE 5. SPECIAL SELECTIONS AVAILABLE INCLUDE:**

Nominal zener voltages between those shown. Tight voltage tolerances such as  $\pm 1\%$  and  $\pm 2\%$ . Consult factory.

# GENERAL DATA — 500 mW DO-35 GLASS

**ELECTRICAL CHARACTERISTICS** ( $T_A = 25^\circ\text{C}$  unless otherwise noted.)  $V_F = 1.5\text{ V Max}$ ,  $I_F = 200\text{ mA}$  for all types.

Type No. (Note 1)	Zener Voltage (Note 2)		Test Current $I_{ZT}$ mA	Zener Impedance at $I_{ZT}$ $f = 1000\text{ Hz (Ohm)}$		Blocking Voltage $I_R = 1\ \mu\text{A}$	Typical $T_C$ %/°C	Surge Current @ $T_L = 25^\circ\text{C}$ $i_r - \text{mA}$ (Note 3)
	Min	Max		Typ	Max			
MZD3.9	3.7	4.1	100	3.8	7	—	-0.06	1380
MZD4.3	4	4.6	100	3.8	7	—	0.055	1260
MZD4.7	4.4	5	100	3.8	7	—	0.03	1190
MZD5.1	4.8	5.4	100	2	5	—	0.03	1070
MZD5.6	5.2	6	100	1	2	1.5	+0.038	970
MZD6.2	5.8	6.6	100	1	2	1.5	+0.045	890
MZD6.8	6.4	7.2	100	1	2	2	+0.05	810
MZD7.5	7	7.9	100	1	2	2	+0.058	730
MZD8.2	7.7	8.7	100	1	2	3.5	+0.062	660
MZD9.1	8.5	9.6	50	2	4	3.5	+0.068	605
MZD10	9.4	10.6	50	2	4	5	+0.075	550
MZD11	10.4	11.6	50	4	7	5	+0.076	500
MZD12	11.4	12.7	50	4	7	7	+0.077	454
MZD13	12.4	14.1	50	5	10	7	+0.079	414
MZD15	13.8	15.8	50	5	10	10	+0.082	380
MZD16	15.3	17.1	25	6	15	10	+0.083	344
<b>MZD18</b>	<b>16.8</b>	<b>19.1</b>	<b>25</b>	<b>6</b>	<b>15</b>	<b>10</b>	<b>+0.085</b>	<b>304</b>
MZD20	18.8	21.2	25	6	15	10	+0.086	285
MZD22	20.8	23.3	25	6	15	12	+0.087	250
MZD24	22.8	25.6	25	7	15	12	+0.088	225
MZD27	25.1	28.9	25	7	15	14	+0.09	205
MZD30	28	32	25	8	15	14	+0.091	190
MZD33	31	35	25	8	15	17	+0.092	170
MZD36	34	38	10	21	40	17	+0.093	150
MZD39	37	41	10	21	40	20	+0.094	135
MZD43	40	46	10	24	45	20	+0.095	125
MZD47	44	50	10	24	45	24	+0.095	115
MZD51	48	54	10	25	60	24	+0.096	110
MZD56	52	60	10	25	60	28	+0.096	95
MZD62	58	66	10	25	80	28	+0.097	90
MZD68	64	72	10	25	80	34	+0.097	80
MZD75	70	79	10	30	100	34	+0.098	70
MZD82	77	88	10	30	100	41	+0.098	65
MZD91	85	96	5	60	200	41	+0.099	60
MZD100	94	106	5	60	200	50	+0.11	55
MZD110	104	116	5	80	250	50	+0.11	50
MZD120	114	127	5	80	250	60	+0.11	45
MZD130	124	141	5	110	300	60	+0.11	—
MZD150	138	156	5	110	300	75	+0.11	—
MZD160	153	171	5	150	350	75	+0.11	—
MZD180	168	191	5	150	350	90	+0.11	—
MZD200	188	212	5	150	350	90	+0.11	—

**NOTE 1. TOLERANCE AND TYPE NUMBER DESIGNATION**

The type numbers listed have zener voltage min/max limits as shown.

**NOTE 2. ZENER VOLTAGE ( $V_Z$ ) MEASUREMENT**

The zener voltage is measured after the test current ( $I_{ZT}$ ) has been applied for  $40 \pm 10$  milliseconds, while maintaining a lead temperature ( $T_L$ ) of  $30^\circ\text{C}$  at a point of 10 mm from the diode body.

**NOTE 3. ( $i_r$ ) NON-REPETITIVE SURGE CURRENT**

Maximum peak, non-repetitive reverse surge current of half square wave or equivalent sine wave pulse of 50 ms duration, superimposed on the test current ( $I_{ZT}$ ).

**NOTE 4. SPECIAL SELECTIONS AVAILABLE INCLUDE:**

Nominal zener voltages between those shown. Tight voltage tolerances such as  $\pm 1\%$  and  $\pm 2\%$ . Consult factory.

# GENERAL DATA — 500 mW DO-35 GLASS

**ELECTRICAL CHARACTERISTICS** ( $T_A = 25^\circ\text{C}$  unless otherwise noted)  $V_F = 1.5\text{ V Max}$ ,  $I_F = 200\text{ mA}$  for all types

Motorola Type No. (Note 1)	Nominal Zener Voltage $V_Z @ I_{ZT}$ Volts (Note 2)	Test Current $I_{ZT}$ mA	Max Zener Impedance (Note 3)			Leakage Current		Surge Current @ $T_A = 25^\circ\text{C}$ $i_r - \text{mA}$ (Note 4)
			$Z_{ZT} @ I_{ZT}$ Ohms	$Z_{ZK} @ I_{ZK}$ Ohms	$I_{ZK}$ mA	$I_R @ V_R$ $\mu\text{A Max}$ @ Volts		
MZP4728A	3.3	76	10	400	1	100	1	1380
MZP4729A	3.6	69	10	400	1	100	1	1260
MZP4730A	3.9	64	9	400	1	50	1	1190
MZP4731A	4.3	58	9	400	1	10	1	1070
MZP4732A	4.7	53	8	500	1	10	1	970
MZP4733A	5.1	49	7	550	1	10	1	890
MZP4734A	5.6	45	5	600	1	10	2	810
MZP4735A	6.2	41	2	700	1	10	3	730
MZP4736A	6.8	37	3.5	700	1	10	4	660
MZP4737A	7.5	34	4	700	0.5	10	5	605
MZP4738A	8.2	31	4.5	700	0.5	10	6	550
MZP4739A	9.1	28	5	700	0.5	10	7	500
MZP4740A	10	25	7	700	0.25	10	7.6	454
MZP4741A	11	23	8	700	0.25	5	8.4	414
MZP4742A	12	21	9	700	0.25	5	9.1	380
MZP4743A	13	19	10	700	0.25	5	9.9	344
MZP4744A	15	17	14	700	0.25	5	11.4	304
MZP4745A	16	15.5	16	700	0.25	5	12.2	285
<b>MZP4746A</b>	<b>18</b>	<b>14</b>	<b>20</b>	<b>750</b>	<b>0.25</b>	<b>5</b>	<b>13.7</b>	<b>250</b>
MZP4747A	20	12.5	22	750	0.25	5	15.2	225
MZP4748A	22	11.5	23	750	0.25	5	16.7	205
<b>MZP4749A</b>	<b>24</b>	<b>10.5</b>	<b>25</b>	<b>750</b>	<b>0.25</b>	<b>5</b>	<b>18.2</b>	<b>190</b>
MZP4750A	27	9.5	35	750	0.25	5	20.6	170
<b>MZP4751A</b>	<b>30</b>	<b>8.5</b>	<b>40</b>	<b>1000</b>	<b>0.25</b>	<b>5</b>	<b>22.8</b>	<b>150</b>
MZP4752A	33	7.5	45	1000	0.25	5	25.1	135
MZP4753A	36	7	50	1000	0.25	5	27.4	125
MZP4754A	39	6.5	60	1000	0.25	5	29.7	115
MZP4755A	43	6	70	1500	0.25	5	32.7	110
MZP4756A	47	5.5	80	1500	0.25	5	35.8	95
MZP4757A	51	5	95	1500	0.25	5	38.8	90
MZP4758A	56	4.5	110	2000	0.25	5	42.6	80
MZP4759A	62	4	125	2000	0.25	5	47.1	70
MZP4760A	68	3.7	150	2000	0.25	5	51.7	65
MZP4761A	75	3.3	175	2000	0.25	5	56	60
MZP4762A	82	3	200	3000	0.25	5	62.2	55
MZP4763A	91	2.8	250	3000	0.25	5	69.2	50
MZP4764A	100	2.5	350	3000	0.25	5	76	45
1M110ZS5	110	2.3	450	4000	0.25	5	83.6	—
1M120ZS5	120	2	550	4500	0.25	5	91.2	—
1M130ZS5	130	1.9	700	5000	0.25	5	98.8	—
1M150ZS5	150	1.7	1000	6000	0.25	5	114	—
1M160ZS5	160	1.6	1100	6500	0.25	5	121.6	—
1M180ZS5	180	1.4	1200	7000	0.25	5	136.8	—
1M200ZS5	200	1.2	1500	8000	0.25	5	152	—

**NOTE 1. TOLERANCE AND TYPE NUMBER DESIGNATION**

The type numbers listed have a standard tolerance on the nominal zener voltage of  $\pm 5\%$ . The tolerance on the 1M type numbers is indicated by the digits following ZS in the part number. "5" indicates a  $\pm 5\%$   $V_Z$  tolerance.

**NOTE 2. ZENER VOLTAGE ( $V_Z$ ) MEASUREMENT**

Motorola guarantees the zener voltage when measured at 90 seconds while maintaining the lead temperature ( $T_L$ ) at  $30^\circ\text{C} \pm 1^\circ\text{C}$ , 3/8" from the diode body.

**NOTE 3. ZENER IMPEDANCE ( $Z_Z$ ) DERIVATION**

The zener impedance is derived from the 60 cycle ac voltage, which results when an ac

current having an rms value equal to 10% of the dc zener current ( $I_{ZT}$  or  $I_{ZK}$ ) is superimposed on  $I_{ZT}$  or  $I_{ZK}$ .

**NOTE 4. SURGE CURRENT ( $i_r$ ) NON-REPETITIVE**

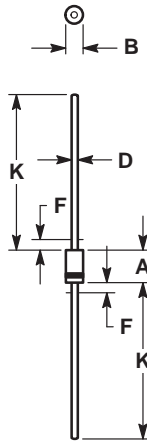
The rating listed in the electrical characteristics table is maximum peak, non-repetitive, reverse surge current of 1/2 square wave or equivalent sine wave pulse of 1/120 second duration superimposed on the test current,  $I_{ZT}$ , however, actual device capability is as described in Figure 3 of General Data — Surmetic 30.

**NOTE 5. SPECIAL SELECTIONS AVAILABLE INCLUDE:**

Nominal zener voltages between those shown. Tight voltage tolerances such as  $\pm 1\%$  and  $\pm 2\%$ . Consult factory.

# Zener Voltage Regulator Diodes — Axial Leded

## 1–3 Watt DO-41 Surmetic 30



- NOTES:
1. ALL RULES AND NOTES ASSOCIATED WITH JEDEC DO-41 OUTLINE SHALL APPLY.
  2. POLARITY DENOTED BY CATHODE BAND.
  3. LEAD DIAMETER NOT CONTROLLED WITHIN F DIMENSION.

DIM	MILLIMETERS		INCHES	
	MIN	MAX	MIN	MAX
A	4.07	5.20	0.160	0.205
B	2.04	2.71	0.080	0.107
D	0.71	0.86	0.028	0.034
F	—	1.27	—	0.050
K	27.94	—	1.100	—

CASE 59-03  
DO-41  
PLASTIC

(Refer to Section 10 for Surface Mount, Thermal Data and Footprint Information.)

### MULTIPLE PACKAGE QUANTITY (MPQ) REQUIREMENTS

Package Option	Type No. Suffix	MPQ (Units)
Tape and Reel	RL	6K
Tape and Ammo	TA	4K

(Refer to Section 10 for more information on Packaging Specifications.)



## 5 Watt Surmetic 40 Silicon Zener Diodes

This is a complete series of 5 Watt Zener Diodes with tight limits and better operating characteristics that reflect the superior capabilities of silicon-oxide-passivated junctions. All this is in an axial-lead, transfer-molded plastic package that offers protection in all common environmental conditions.

**Specification Features:**

- Up to 180 Watt Surge Rating @ 8.3 ms
- Maximum Limits Guaranteed on Seven Electrical Parameters

**Mechanical Characteristics:**

**CASE:** Void-free, transfer-molded, thermosetting plastic

**FINISH:** All external surfaces are corrosion resistant and leads are readily solderable

**POLARITY:** Cathode indicated by color band. When operated in zener mode, cathode will be positive with respect to anode

**MOUNTING POSITION:** Any

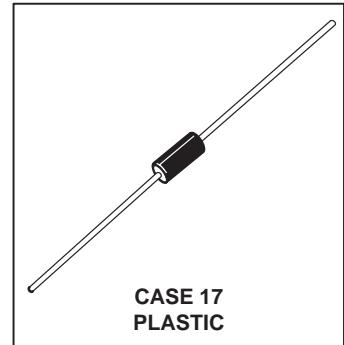
**WEIGHT:** 0.7 gram (approx)

**WAFER FAB LOCATION:** Phoenix, Arizona

**ASSEMBLY/TEST LOCATION:** Seoul, Korea

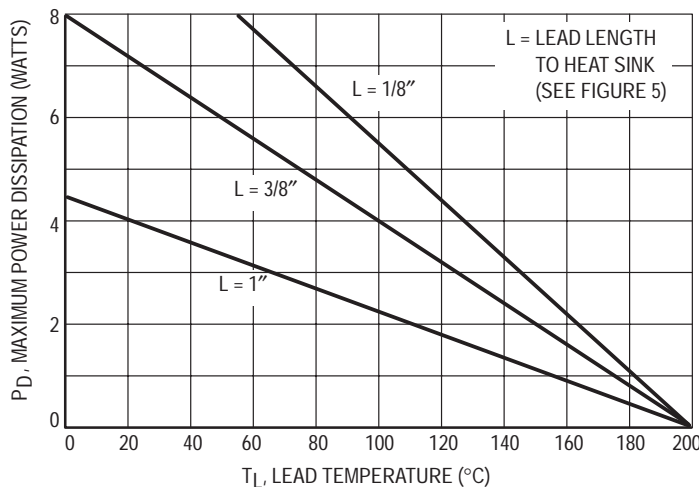
**1N5333B  
 through  
 1N5388B**

**5 WATT  
 ZENER REGULATOR  
 DIODES  
 3.3–200 VOLTS**



**MAXIMUM RATINGS**

Rating	Symbol	Value	Unit
DC Power Dissipation @ $T_L = 75^\circ\text{C}$ Lead Length = 3/8" Derate above 75°C	$P_D$	5 40	Watts mW/°C
Operating and Storage Junction Temperature Range	$T_J, T_{stg}$	- 65 to +200	°C



**Figure 1. Power Temperature Derating Curve**

# 1N5333B through 1N5388B

**ELECTRICAL CHARACTERISTICS** ( $T_A = 25^\circ\text{C}$  unless otherwise noted,  $V_F = 1.2$  Max @  $I_F = 1$  A for all types)

JEDEC Type No. (Note 1)	Nominal Zener Voltage $V_Z$ @ $I_Z$ Volts (Note 2)	Test Current $I_Z$ mA	Max Zener Impedance		Max Reverse Leakage Current		Max Surge Current $i_p$ , Amps (Note 3)	Max Voltage Regulation $\Delta V_Z$ , Volt (Note 4)	Maximum Regulator Current $I_{ZM}$ mA (Note 5)
			$Z_{ZT}$ @ $I_{ZT}$ Ohms (Note 2)	$Z_{ZK}$ @ $I_{ZK} = 1$ mA Ohms (Note 2)	$I_R$ @ $V_R$ $\mu\text{A}$ Volts				
<b>1N5333B</b>	<b>3.3</b>	<b>380</b>	<b>3</b>	<b>400</b>	<b>300</b>	<b>1</b>	<b>20</b>	<b>0.85</b>	<b>1440</b>
1N5334B	3.6	350	2.5	500	150	1	18.7	0.8	1320
1N5335B	3.9	320	2	500	50	1	17.6	0.54	1220
1N5336B	4.3	290	2	500	10	1	16.4	0.49	1100
<b>1N5337B</b>	<b>4.7</b>	<b>260</b>	<b>2</b>	<b>450</b>	<b>5</b>	<b>1</b>	<b>15.3</b>	<b>0.44</b>	<b>1010</b>
<b>1N5338B</b>	<b>5.1</b>	<b>240</b>	<b>1.5</b>	<b>400</b>	<b>1</b>	<b>1</b>	<b>14.4</b>	<b>0.39</b>	<b>930</b>
<b>1N5339B</b>	<b>5.6</b>	<b>220</b>	<b>1</b>	<b>400</b>	<b>1</b>	<b>2</b>	<b>13.4</b>	<b>0.25</b>	<b>865</b>
1N5340B	6	200	1	300	1	3	12.7	0.19	790
<b>1N5341B</b>	<b>6.2</b>	<b>200</b>	<b>1</b>	<b>200</b>	<b>1</b>	<b>3</b>	<b>12.4</b>	<b>0.1</b>	<b>765</b>
<b>1N5342B</b>	<b>6.8</b>	<b>175</b>	<b>1</b>	<b>200</b>	<b>10</b>	<b>5.2</b>	<b>11.5</b>	<b>0.15</b>	<b>700</b>
1N5343B	7.5	175	1.5	200	10	5.7	10.7	0.15	630
1N5344B	8.2	150	1.5	200	10	6.2	10	0.2	580
1N5345B	8.7	150	2	200	10	6.6	9.5	0.2	545
1N5346B	9.1	150	2	150	7.5	6.9	9.2	0.22	520
<b>1N5347B</b>	<b>10</b>	<b>125</b>	<b>2</b>	<b>125</b>	<b>5</b>	<b>7.6</b>	<b>8.6</b>	<b>0.22</b>	<b>475</b>
1N5348B	11	125	2.5	125	5	8.4	8	0.25	430
<b>1N5349B</b>	<b>12</b>	<b>100</b>	<b>2.5</b>	<b>125</b>	<b>2</b>	<b>9.1</b>	<b>7.5</b>	<b>0.25</b>	<b>395</b>
<b>1N5350B</b>	<b>13</b>	<b>100</b>	<b>2.5</b>	<b>100</b>	<b>1</b>	<b>9.9</b>	<b>7</b>	<b>0.25</b>	<b>365</b>
1N5351B	14	100	2.5	75	1	10.6	6.7	0.25	340
<b>1N5352B</b>	<b>15</b>	<b>75</b>	<b>2.5</b>	<b>75</b>	<b>1</b>	<b>11.5</b>	<b>6.3</b>	<b>0.25</b>	<b>315</b>
<b>1N5353B</b>	<b>16</b>	<b>75</b>	<b>2.5</b>	<b>75</b>	<b>1</b>	<b>12.2</b>	<b>6</b>	<b>0.3</b>	<b>295</b>
1N5354B	17	70	2.5	75	0.5	12.9	5.8	0.35	280
1N5355B	18	65	2.5	75	0.5	13.7	5.5	0.4	265
1N5356B	19	65	3	75	0.5	14.4	5.3	0.4	250
1N5357B	20	65	3	75	0.5	15.2	5.1	0.4	237
<b>1N5358B</b>	<b>22</b>	<b>50</b>	<b>3.5</b>	<b>75</b>	<b>0.5</b>	<b>16.7</b>	<b>4.7</b>	<b>0.45</b>	<b>216</b>
<b>1N5359B</b>	<b>24</b>	<b>50</b>	<b>3.5</b>	<b>100</b>	<b>0.5</b>	<b>18.2</b>	<b>4.4</b>	<b>0.55</b>	<b>198</b>
1N5360B	25	50	4	110	0.5	19	4.3	0.55	190
<b>1N5361B</b>	<b>27</b>	<b>50</b>	<b>5</b>	<b>120</b>	<b>0.5</b>	<b>20.6</b>	<b>4.1</b>	<b>0.6</b>	<b>176</b>
1N5362B	28	50	6	130	0.5	21.2	3.9	0.6	170
1N5363B	30	40	8	140	0.5	22.8	3.7	0.6	158
1N5364B	33	40	10	150	0.5	25.1	3.5	0.6	144
<b>1N5365B</b>	<b>36</b>	<b>30</b>	<b>11</b>	<b>160</b>	<b>0.5</b>	<b>27.4</b>	<b>3.3</b>	<b>0.65</b>	<b>132</b>
1N5366B	39	30	14	170	0.5	29.7	3.1	0.65	122
1N5367B	43	30	20	190	0.5	32.7	2.8	0.7	110
<b>1N5368B</b>	<b>47</b>	<b>25</b>	<b>25</b>	<b>210</b>	<b>0.5</b>	<b>35.8</b>	<b>2.7</b>	<b>0.8</b>	<b>100</b>
1N5369B	51	25	27	230	0.5	38.8	2.5	0.9	93
1N5370B	56	20	35	280	0.5	42.6	2.3	1	86
1N5371B	60	20	40	350	0.5	42.5	2.2	1.2	79
1N5372B	62	20	42	400	0.5	47.1	2.1	1.35	76
1N5373B	68	20	44	500	0.5	51.7	2	1.5	70
1N5374B	75	20	45	620	0.5	56	1.9	1.6	63
1N5375B	82	15	65	720	0.5	62.2	1.8	1.8	58
1N5376B	87	15	75	760	0.5	66	1.7	2	54.5
1N5377B	91	15	75	760	0.5	69.2	1.6	2.2	52.5
1N5378B	100	12	90	800	0.5	76	1.5	2.5	47.5
1N5379B	110	12	125	1000	0.5	83.6	1.4	2.5	43
1N5380B	120	10	170	1150	0.5	91.2	1.3	2.5	39.5
1N5381B	130	10	190	1250	0.5	98.8	1.2	2.5	36.6
1N5382B	140	8	230	1500	0.5	106	1.2	2.5	34

(continued)

Devices listed in bold, italic are Motorola preferred devices.

# 1N5333B through 1N5388B

## ELECTRICAL CHARACTERISTICS — continued ( $T_A = 25^\circ\text{C}$ unless otherwise noted, $V_F = 1.2 \text{ Max @ } I_F = 1 \text{ A}$ for all types)

JEDEC Type No. (Note 1)	Nominal Zener Voltage $V_Z @ I_{ZT}$ Volts (Note 2)	Test Current $I_{ZT}$ mA	Max Zener Impedance		Max Reverse Leakage Current		Max Surge Current $i_r$ , Amps (Note 3)	Max Voltage Regulation $\Delta V_Z$ , Volt (Note 4)	Maximum Regulator Current $I_{ZM}$ mA (Note 5)
			$Z_{ZT} @ I_{ZT}$ Ohms (Note 2)	$Z_{ZK} @ I_{ZK} = 1 \text{ mA}$ Ohms (Note 2)	$I_R @ V_R$ $\mu\text{A}$ Volts				
<b>1N5333B</b>	<b>150</b>	<b>8</b>	<b>330</b>	<b>1500</b>	<b>0.5</b>	<b>114</b>	<b>1.1</b>	<b>3</b>	<b>31.6</b>
1N5384B	160	8	350	1650	0.5	122	1.1	3	29.4
1N5385B	170	8	380	1750	0.5	129	1	3	28
1N5386B	180	5	430	1750	0.5	137	1	4	26.4
1N5387B	190	5	450	1850	0.5	144	0.9	5	25
1N5388B	200	5	480	1850	0.5	152	0.9	5	23.6

### NOTE 1. TOLERANCE AND TYPE NUMBER DESIGNATION

The JEDEC type numbers shown indicate a tolerance of  $\pm 5\%$ .

### NOTE 2. ZENER VOLTAGE ( $V_Z$ ) AND IMPEDANCE ( $Z_{ZT}$ & $Z_{ZK}$ )

Test conditions for zener voltage and impedance are as follows:  $I_Z$  is applied  $40 \pm 10$  ms prior to reading. Mounting contacts are located  $3/8''$  to  $1/2''$  from the inside edge of mounting clips to the body of the diode. ( $T_A = 25^\circ\text{C} +8, -2^\circ\text{C}$ ).

### NOTE 3. SURGE CURRENT ( $i_r$ )

Surge current is specified as the maximum allowable peak, non-recurrent square-wave current with a pulse width, PW, of 8.3 ms. The data given in Figure 6 may be used to find the maximum surge current for a square wave of any pulse width between 1 ms and 1000 ms by plotting the applicable points on logarithmic paper. Examples of this, using the 3.3 V and 200 V zeners, are shown in Figure 7. Mounting contact located as specified in Note 3. ( $T_A = 25^\circ\text{C} +8, -2^\circ\text{C}$ ).

### NOTE 4. VOLTAGE REGULATION ( $\Delta V_Z$ )

Test conditions for voltage regulation are as follows:  $V_Z$  measurements are made at 10% and then at 50% of the  $I_Z$  max value listed in the electrical characteristics table. The test current time duration for each  $V_Z$  measurement is  $40 \pm 10$  ms. ( $T_A = 25^\circ\text{C} +8, -2^\circ\text{C}$ ). Mounting contact located as specified in Note 2.

### NOTE 5. MAXIMUM REGULATOR CURRENT ( $I_{ZM}$ )

The maximum current shown is based on the maximum voltage of a 5% type unit, therefore, it applies only to the B-suffix device. The actual  $I_{ZM}$  for any device may not exceed the value of 5 watts divided by the actual  $V_Z$  of the device.  $T_L = 75^\circ\text{C}$  at  $3/8''$  maximum from the device body.

### NOTE 6. SPECIALS AVAILABLE INCLUDE:

Nominal zener voltages between the voltages shown and tighter voltage tolerance such as  $\pm 1\%$  and  $\pm 2\%$ . Consult factory.

## TEMPERATURE COEFFICIENTS

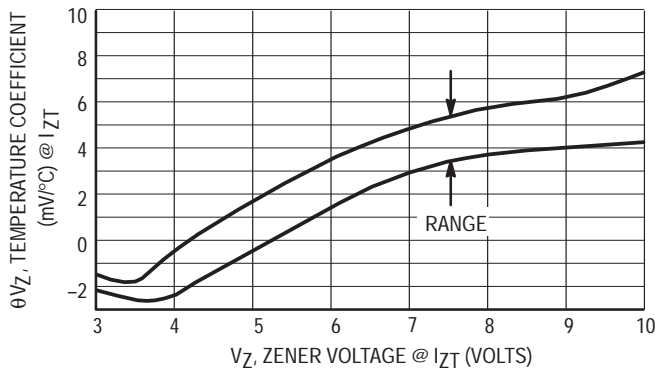


Figure 2. Temperature Coefficient-Range for Units 3 to 10 Volts

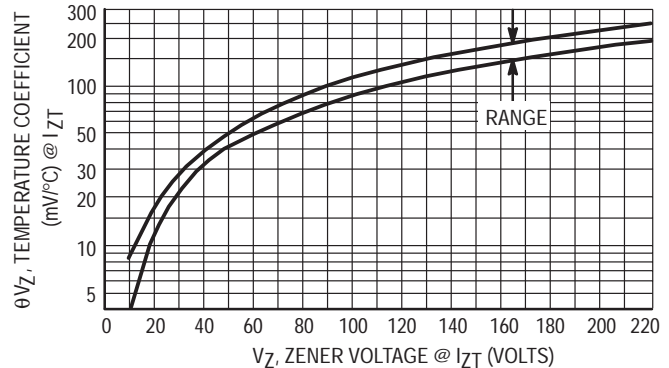
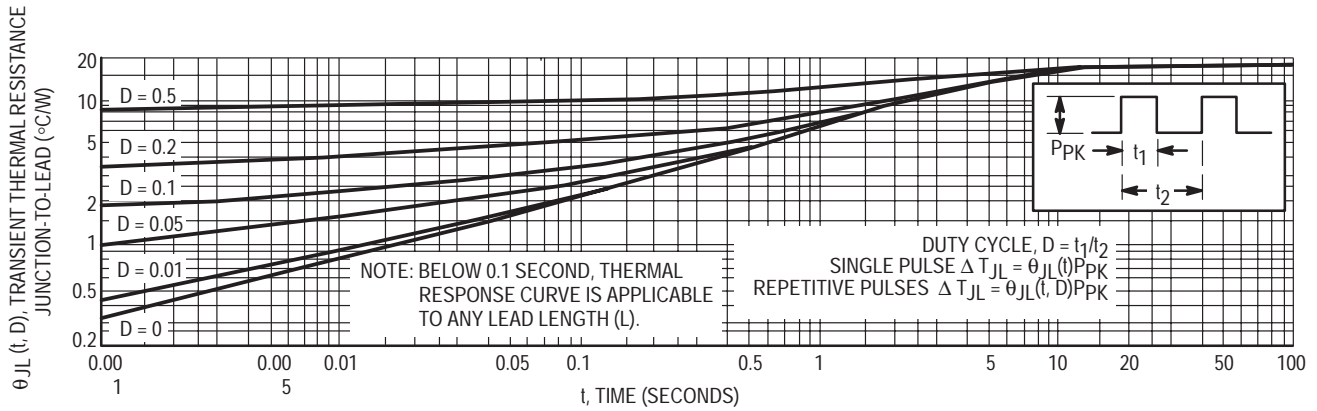


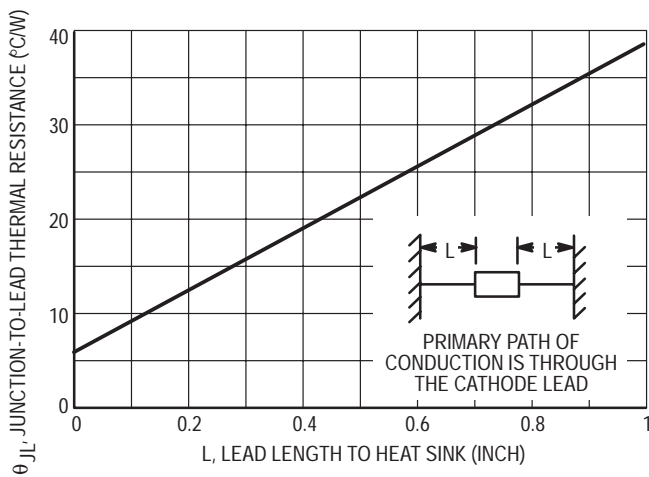
Figure 3. Temperature Coefficient-Range for Units 10 to 220 Volts

Devices listed in bold, italic are Motorola preferred devices.

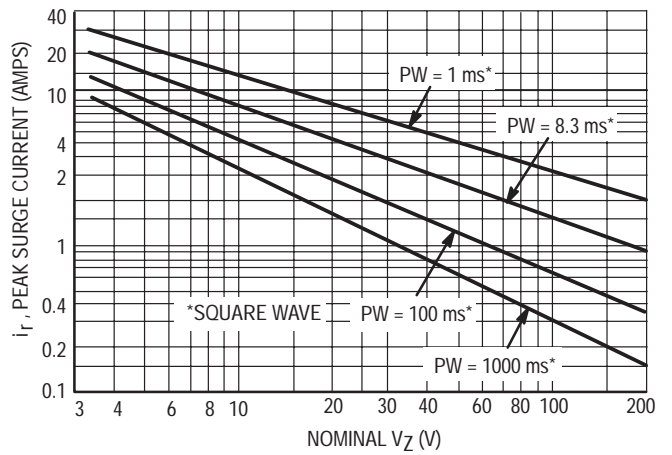
# 1N5333B through 1N5388B



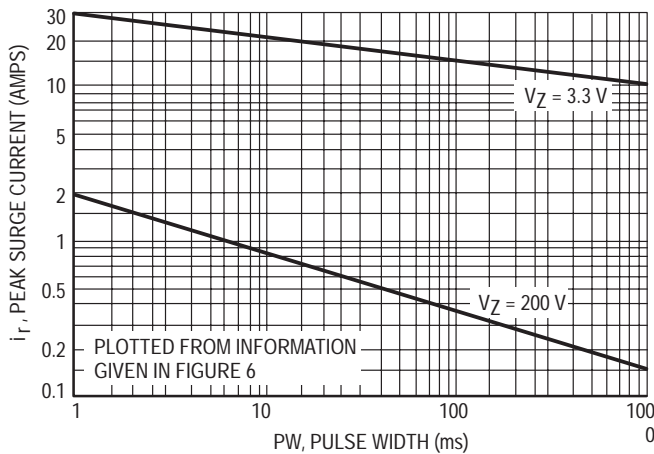
**Figure 4. Typical Thermal Response**  
**L, Lead Length = 3/8 Inch**



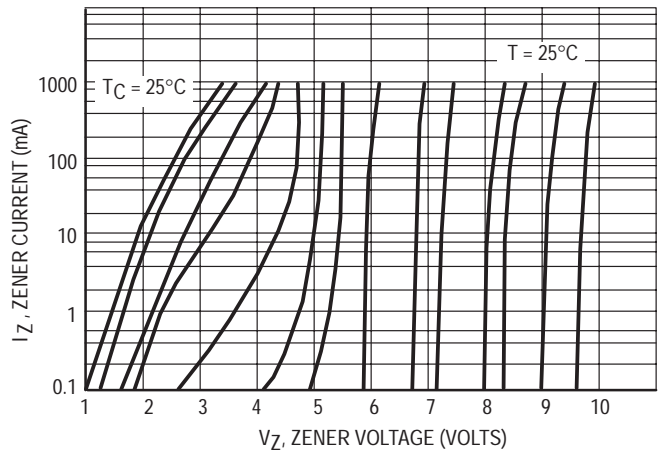
**Figure 5. Typical Thermal Resistance**



**Figure 6. Maximum Non-Repetitive Surge Current versus Nominal Zener Voltage**  
 (See Note 3)

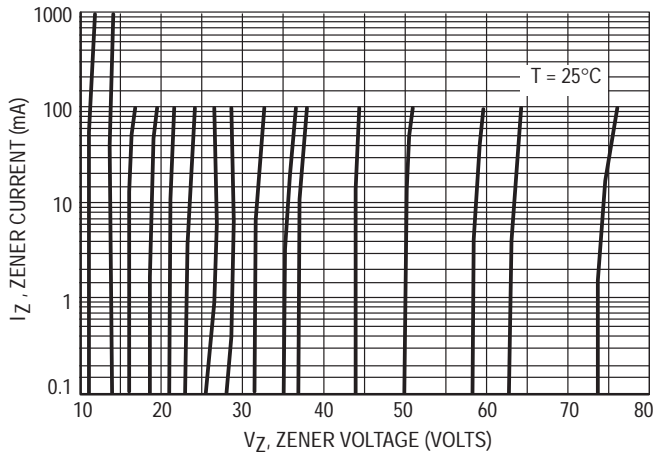


**Figure 7. Peak Surge Current versus Pulse Width**  
 (See Note 3)

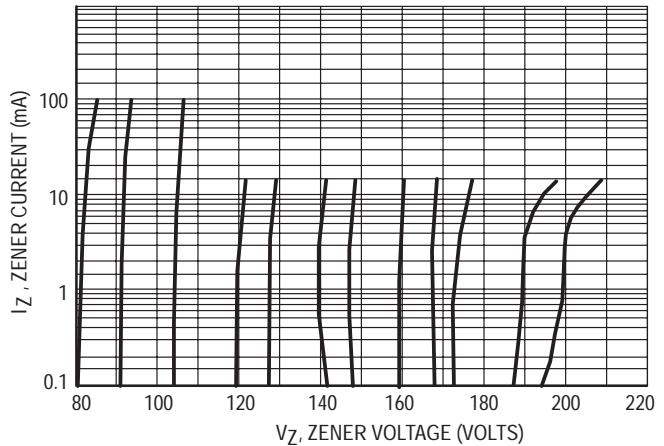


**Figure 8. Zener Voltage versus Zener Current**  
 **$V_Z = 3.3$  thru  $10$  Volts**

# 1N5333B through 1N5388B



**Figure 9. Zener Voltage versus Zener Current**  
 **$V_Z = 11$  thru  $75$  Volts**



**Figure 10. Zener Voltage versus Zener Current**  
 **$V_Z = 82$  thru  $200$  Volts**

## APPLICATION NOTE

Since the actual voltage available from a given zener diode is temperature dependent, it is necessary to determine junction temperature under any set of operating conditions in order to calculate its value. The following procedure is recommended:

Lead Temperature,  $T_L$ , should be determined from:

$$T_L = \theta_{LA} P_D + T_A$$

$\theta_{LA}$  is the lead-to-ambient thermal resistance and  $P_D$  is the power dissipation.

Junction Temperature,  $T_J$ , may be found from:

$$T_J = T_L + \Delta T_{JL}$$

$\Delta T_{JL}$  is the increase in junction temperature above the lead temperature and may be found from Figure 4 for a train of power pulses or from Figure 5 for dc power.

$$\Delta T_{JL} = \theta_{JL} P_D$$

For worst-case design, using expected limits of  $I_Z$ , limits of  $P_D$  and the extremes of  $T_J$  ( $\Delta T_J$ ) may be estimated. Changes in voltage,  $V_Z$ , can then be found from:

$$\Delta V = \theta_{VZ} \Delta T_J$$

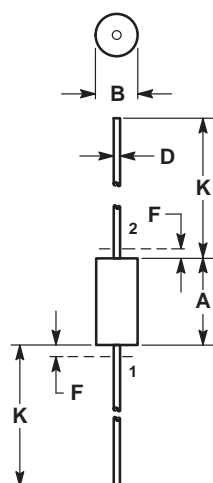
$\theta_{VZ}$ , the zener voltage temperature coefficient, is found from Figures 2 and 3.

Under high power-pulse operation, the zener voltage will vary with time and may also be affected significantly by the zener resistance. For best regulation, keep current excursions as low as possible.

Data of Figure 4 should not be used to compute surge capability. Surge limitations are given in Figure 6. They are lower than would be expected by considering only junction temperature, as current crowding effects cause temperatures to be extremely high in small spots resulting in device degradation should the limits of Figure 6 be exceeded.

# Zener Voltage Regulator Diodes — Axial Leaded

## 5 Watt Surmetic 40



NOTE:  
1. LEAD DIAMETER & FINISH NOT CONTROLLED WITHIN DIM F.

DIM	INCHES		MILLIMETERS	
	MIN	MAX	MIN	MAX
A	0.330	0.350	8.38	8.89
B	0.130	0.145	3.30	3.68
D	0.037	0.043	0.94	1.09
F	—	0.050	—	1.27
K	1.000	1.250	25.40	31.75

CASE 17-02  
PLASTIC

(Refer to Section 10 for Surface Mount, Thermal Data and Footprint Information.)

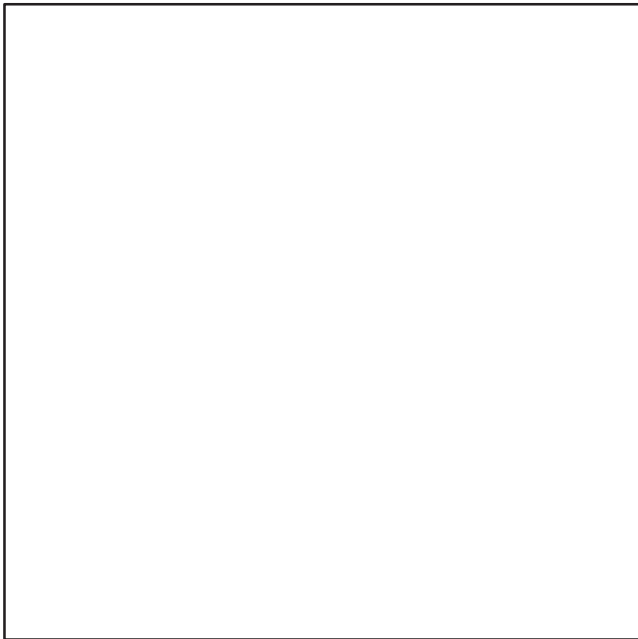
### MULTIPLE PACKAGE QUANTITY (MPQ) REQUIREMENTS

Package Option	Type No. Suffix	MPQ (Units)
Tape and Reel	RL	4K
Tape and Ammo	TA	2K

(Refer to Section 10 for more information on Packaging Specifications.)



# Section Seven



## Zener Voltage Regulator Diodes — Surface Mounted Data Sheets

### 225 mW (SOT-23)

General Data	7-2
BZX84C2V4LT1 through BZX84C75LT1	.. NO TAG
MMBZ5221BLT1 through MMBZ5270BLT1	NO TAG

### 500 mW (SOD-123)

General Data	7-8
MMSZ5221BT1 through MMSZ5270BT1	7-8
MMSZ4678T1 through MMSZ4717T1	.. NO TAG
MMSZ2V4T1 through MMSZ75T1	.. NO TAG

### 3 Watt DC Power (SMB Flat Plastic with Modified L-Bend Leads)

General Data	7-17
1SMB5913BT3 through 1SMB5956BT3	7-17



225 mW SOT-23  
 Zener Voltage Regulator Diodes  
**GENERAL DATA APPLICABLE TO ALL SERIES IN THIS GROUP**  
**Zener Voltage Regulator Diodes**

**Manufacturing Locations:**

**WAFER FAB:** Phoenix, Arizona

**ASSEMBLY:** Seremban, Malaysia

**TEST:** Seremban, Malaysia

**MAXIMUM CASE TEMPERATURE FOR SOLDERING**

**PURPOSES:** 260°C for 10 seconds

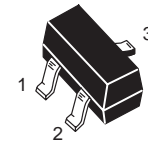
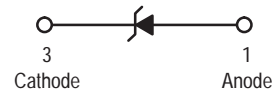
**THERMAL CHARACTERISTICS**

Characteristic	Symbol	Max	Unit
Total Device Dissipation FR-5 Board,* T <sub>A</sub> = 25°C Derate above 25°C	P <sub>D</sub>	225	mW
		1.8	mW/°C
Thermal Resistance Junction to Ambient	R <sub>θJA</sub>	556	°C/W
Total Device Dissipation Alumina Substrate,** T <sub>A</sub> = 25°C Derate above 25°C	P <sub>D</sub>	300	mW
		2.4	mW/°C
Thermal Resistance Junction to Ambient	R <sub>θJA</sub>	417	°C/W
Junction and Storage Temperature	T <sub>J</sub> , T <sub>stg</sub>	150	°C

\*FR-5 = 1.0 x 0.75 x 0.62 in.

\*\*Alumina = 0.4 x 0.3 x 0.024 in. 99.5% alumina.

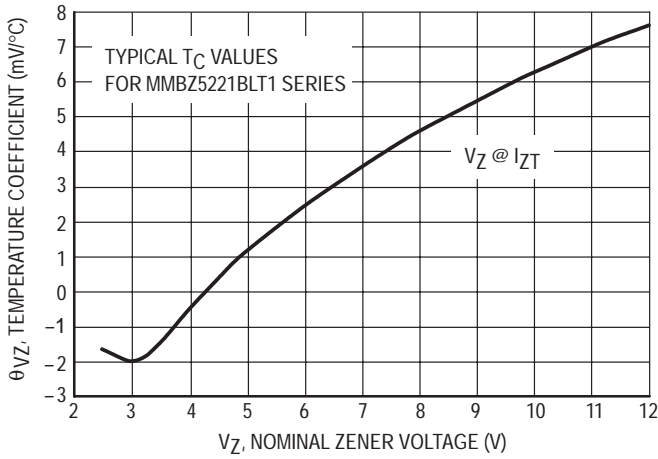
**GENERAL  
 DATA**  
**225 mW  
 SOT-23**



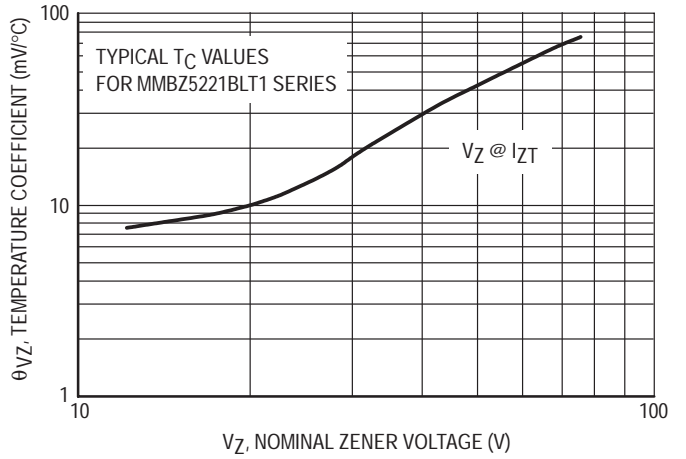
**CASE 318-07, STYLE 8  
 SOT-23 (TO-236AB)  
 PLASTIC**

# GENERAL DATA — 225 mW SOT-23

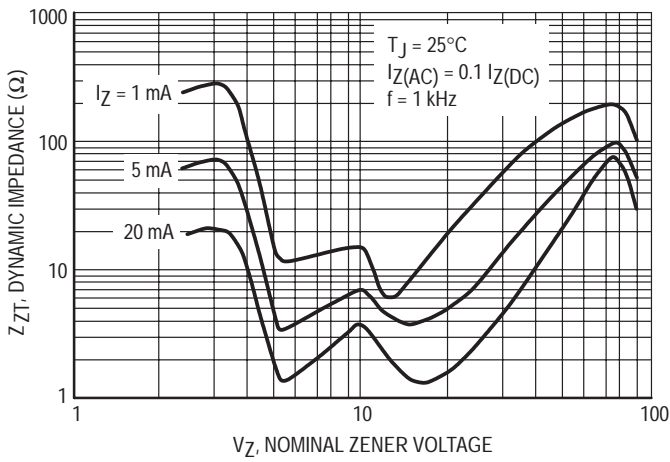
## TYPICAL CHARACTERISTICS



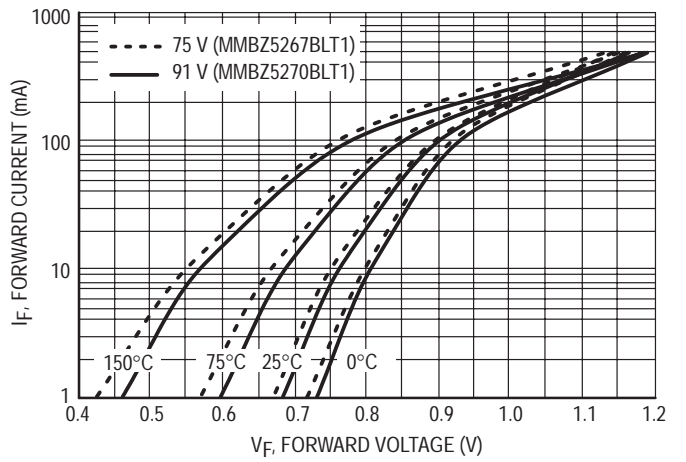
**Figure 1. Temperature Coefficients (Temperature Range -55°C to +150°C)**



**Figure 2. Temperature Coefficients (Temperature Range -55°C to +150°C)**



**Figure 3. Effect of Zener Voltage on Zener Impedance**



**Figure 4. Typical Forward Voltage**

# GENERAL DATA — 225 mW SOT-23

## TYPICAL CHARACTERISTICS

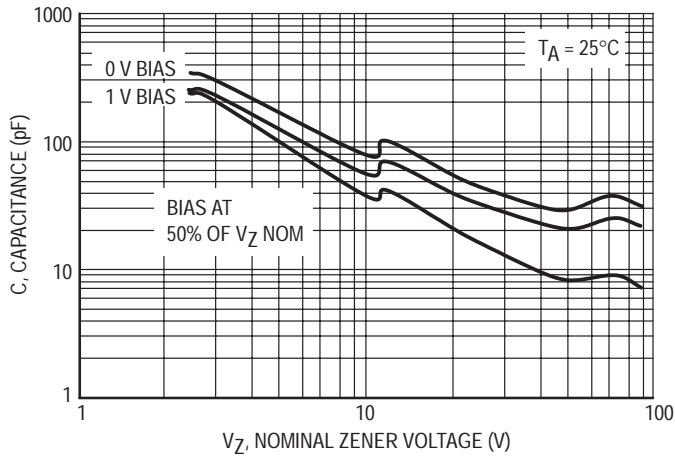


Figure 5. Typical Capacitance

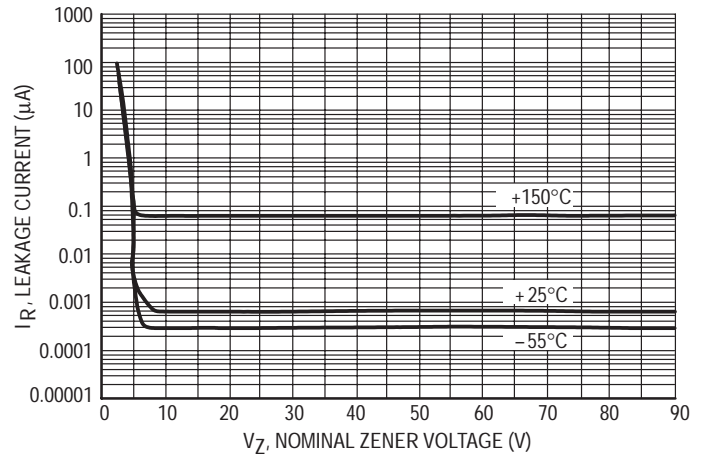


Figure 6. Typical Leakage Current

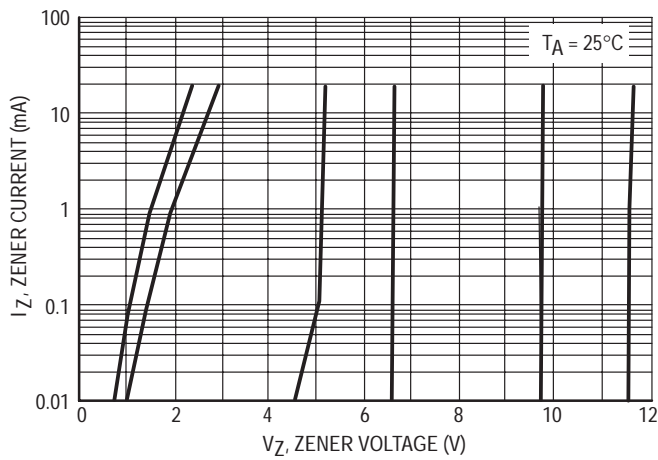


Figure 7. Zener Voltage versus Zener Current ( $V_Z$  Up to 12 V)

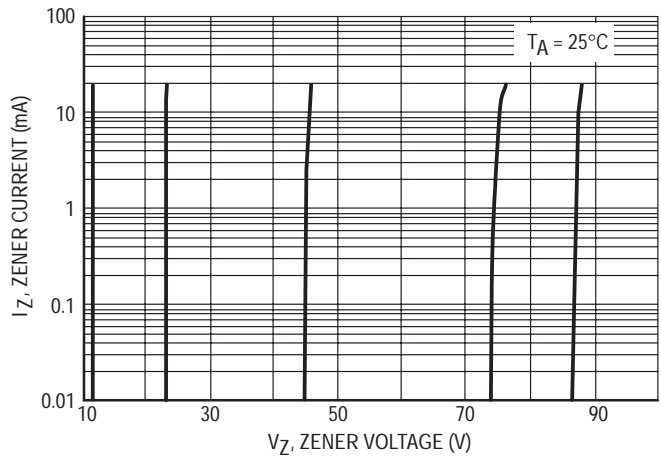


Figure 8. Zener Voltage versus Zener Current (12 V to 91 V)

# GENERAL DATA — 225 mW SOT-23

## ELECTRICAL CHARACTERISTICS (Pinout: 1-Anode, 2-NC, 3-Cathode) ( $V_F = 0.9\text{ V Max @ } I_F = 10\text{ mA}$ for all types)

Type Number	Marking	Zener Voltage $V_{Z1}$ (Volts) @ $I_{ZT1} = 5\text{ mA}$ (Note 1)			Max Zener Impedance $Z_{ZT1}$ (Ohms) @ $I_{ZT1} = 5\text{ mA}$	Max Reverse Leakage Current		Zener Voltage $V_{Z2}$ (Volts) @ $I_{ZT2} = 1\text{ mA}$ (Note 1)		Max Zener Impedance $Z_{ZT2}$ (Ohms) @ $I_{ZT2} = 1\text{ mA}$	Zener Voltage $V_{Z3}$ (Volts) @ $I_{ZT3} = 20\text{ mA}$ (Note 1)		Max Zener Impedance $Z_{ZT3}$ (Ohms) @ $I_{ZT3} = 20\text{ mA}$	$dV_Z/dt$ (mV/k) @ $I_{ZT1} = 5\text{ mA}$		C pF Max @ $V_R = 0$ $f = 1\text{ MHz}$
		Nom	Min	Max		$I_R$ $\mu\text{A}$	$V_R$ Volts	Min	Max		Min	Max		Min	Max	
				$V_{Z1}$ Below @ $I_{ZT1} = 2\text{ mA}$			$Z_{ZT1}$ Below @ $I_{ZT1} = 2\text{ mA}$			$V_{Z2}$ Below @ $I_{ZT2} = 0.1\text{ mA}$		$Z_{ZT2}$ Below @ $I_{ZT4} = 0.5\text{ mA}$ (Note 2)	$V_{Z3}$ Below @ $I_{ZT3} = 10\text{ mA}$		$Z_{ZT3}$ Below @ $I_{ZT3} = 10\text{ mA}$	$dV_Z/dt$ (mV/k) Below @ $I_{ZT1} = 2\text{ mA}$
BZX84C2V4LT1	Z11	2.4	2.2	2.6	100	50	1	1.7	2.1	600	2.6	3.2	50	-3.5	0	450
BZX84C2V7LT1	Z12	2.7	2.5	2.9	100	20	1	1.9	2.4	600	3	3.6	50	-3.5	0	450
BZX84C3V0LT1	Z13	3	2.8	3.2	95	10	1	2.1	2.7	600	3.3	3.9	50	-3.5	0	450
BZX84C3V3LT1	Z14	3.3	3.1	3.5	95	5	1	2.3	2.9	600	3.6	4.2	40	-3.5	0	450
BZX84C3V6LT1	Z15	3.6	3.4	3.8	90	5	1	2.7	3.3	600	3.9	4.5	40	-3.5	0	450
BZX84C3V9LT1	Z16	3.9	3.7	4.1	90	3	1	2.9	3.5	600	4.1	4.7	30	-3.5	-2.5	450
BZX84C4V3LT1	W9	4.3	4	4.6	90	3	1	3.3	4	600	4.4	5.1	30	-3.5	0	450
<b>BZX84C4V7LT1</b>	<b>Z1</b>	<b>4.7</b>	<b>4.4</b>	<b>5</b>	<b>80</b>	<b>3</b>	<b>2</b>	<b>3.7</b>	<b>4.7</b>	<b>500</b>	<b>4.5</b>	<b>5.4</b>	<b>15</b>	<b>-3.5</b>	<b>0.2</b>	<b>260</b>
<b>BZX84C5V1LT1</b>	<b>Z2</b>	<b>5.1</b>	<b>4.8</b>	<b>5.4</b>	<b>60</b>	<b>2</b>	<b>2</b>	<b>4.2</b>	<b>5.3</b>	<b>480</b>	<b>5</b>	<b>5.9</b>	<b>15</b>	<b>-2.7</b>	<b>1.2</b>	<b>225</b>
<b>BZX84C5V6LT1</b>	<b>Z3</b>	<b>5.6</b>	<b>5.2</b>	<b>6</b>	<b>40</b>	<b>1</b>	<b>2</b>	<b>4.8</b>	<b>6</b>	<b>400</b>	<b>5.2</b>	<b>6.3</b>	<b>10</b>	<b>-2.0</b>	<b>2.5</b>	<b>200</b>
<b>BZX84C6V2LT1</b>	<b>Z4</b>	<b>6.2</b>	<b>5.8</b>	<b>6.6</b>	<b>10</b>	<b>3</b>	<b>4</b>	<b>5.6</b>	<b>6.6</b>	<b>150</b>	<b>5.8</b>	<b>6.8</b>	<b>6</b>	<b>0.4</b>	<b>3.7</b>	<b>185</b>
BZX84C6V8LT1	Z5	6.8	6.4	7.2	15	2	4	6.3	7.2	80	6.4	7.4	6	1.2	4.5	155
BZX84C7V5LT1	Z6	7.5	7	7.9	15	1	5	6.9	7.9	80	7	8	6	2.5	5.3	140
BZX84C8V2LT1	Z7	8.2	7.7	8.7	15	0.7	5	7.6	8.7	80	7.7	8.8	6	3.2	6.2	135
BZX84C9V1LT1	Z8	9.1	8.5	9.6	15	0.5	6	8.4	9.6	100	8.5	9.7	8	3.8	7.0	130
BZX84C10LT1	Z9	10	9.4	10.6	20	0.2	7	9.3	10.6	150	9.4	10.7	10	4.5	8.0	130
BZX84C11LT1	Y1	11	10.4	11.6	20	0.1	8	10.2	11.6	150	10.4	11.8	10	5.4	9.0	130
<b>BZX84C12LT1</b>	<b>Y2</b>	<b>12</b>	<b>11.4</b>	<b>12.7</b>	<b>25</b>	<b>0.1</b>	<b>8</b>	<b>11.2</b>	<b>12.7</b>	<b>150</b>	<b>11.4</b>	<b>12.9</b>	<b>10</b>	<b>6.0</b>	<b>10.0</b>	<b>130</b>
BZX84C13LT1	Y3	13	12.4	14.1	30	0.1	8	12.3	14	170	12.5	14.2	15	7.0	11.0	120
BZX84C15LT1	Y4	15	13.8	15.6	30	0.05	10.5	13.7	15.5	200	13.9	15.7	20	9.2	13.0	110
BZX84C16LT1	Y5	16	15.3	17.1	40	0.05	11.2	15.2	17	200	15.4	17.2	20	10.4	14.0	105
<b>BZX84C18LT1</b>	<b>Y6</b>	<b>18</b>	<b>16.8</b>	<b>19.1</b>	<b>45</b>	<b>0.05</b>	<b>12.6</b>	<b>16.7</b>	<b>19</b>	<b>225</b>	<b>16.9</b>	<b>19.2</b>	<b>20</b>	<b>12.4</b>	<b>16.0</b>	<b>100</b>
BZX84C20LT1	Y7	20	18.8	21.2	55	0.05	14	18.7	21.1	225	18.9	21.4	20	14.4	18.0	85
BZX84C22LT1	Y8	22	20.8	23.3	55	0.05	15.4	20.7	23.2	250	20.9	23.4	25	16.4	20.0	85
BZX84C24LT1	Y9	24	22.8	25.6	70	0.05	16.8	22.7	25.5	250	22.9	25.7	25	18.4	22.0	80
		$V_{Z1}$ Below @ $I_{ZT1} = 2\text{ mA}$			$Z_{ZT1}$ Below @ $I_{ZT1} = 2\text{ mA}$			$V_{Z2}$ Below @ $I_{ZT2} = 0.1\text{ mA}$		$Z_{ZT2}$ Below @ $I_{ZT4} = 0.5\text{ mA}$ (Note 2)	$V_{Z3}$ Below @ $I_{ZT3} = 10\text{ mA}$		$Z_{ZT3}$ Below @ $I_{ZT3} = 10\text{ mA}$	$dV_Z/dt$ (mV/k) Below @ $I_{ZT1} = 2\text{ mA}$		
BZX84C27LT1	Y10	27	25.1	28.9	80	0.05	18.9	25	28.9	300	25.2	29.3	45	21.4	25.3	70
BZX84C30LT1	Y11	30	28	32	80	0.05	21	27.8	32	300	28.1	32.4	50	24.4	29.4	70
BZX84C33LT1	Y12	33	31	35	80	0.05	23.1	30.8	35	325	31.1	35.4	55	27.4	33.4	70
BZX84C36LT1	Y13	36	34	38	90	0.05	25.2	33.8	38	350	34.1	38.4	60	30.4	37.4	70
BZX84C39LT1	Y14	39	37	41	130	0.05	27.3	36.7	41	350	37.1	41.5	70	33.4	41.2	45
BZX84C43LT1	Y15	43	40	46	150	0.05	30.1	39.7	46	375	40.1	46.5	80	37.6	46.6	40
BZX84C47LT1	Y16	47	44	50	170	0.05	32.9	43.7	50	375	44.1	50.5	90	42.0	51.8	40
BZX84C51LT1	Y17	51	48	54	180	0.05	35.7	47.6	54	400	48.1	54.6	100	46.6	57.2	40
BZX84C56LT1	Y18	56	52	60	200	0.05	39.2	51.5	60	425	52.1	60.8	110	52.2	63.8	40
BZX84C62LT1	Y19	62	58	66	215	0.05	43.4	57.4	66	450	58.2	67	120	58.8	71.6	35
BZX84C68LT1	Y20	68	64	72	240	0.05	47.6	63.4	72	475	64.2	73.2	130	65.6	79.8	35
BZX84C75LT1	Y21	75	70	79	255	0.05	52.5	69.4	79	500	70.3	80.2	140	73.4	88.6	35

NOTES: 1. Zener voltage is measured with a pulse test current ( $I_Z$ ) applied at an ambient temperature of 25°C.

2. The zener impedance,  $Z_{ZT2}$ , for the 27 through 75 volt types is tested at 0.5 mA rather than the test current of 0.1 mA used for  $V_{Z2}$ .

# Zener Voltage Regulator Diodes — Surface Mounted

## 225 mW SOT-23

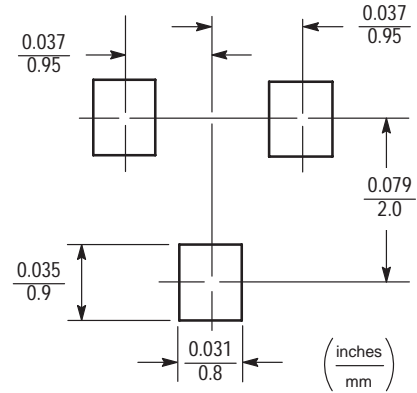
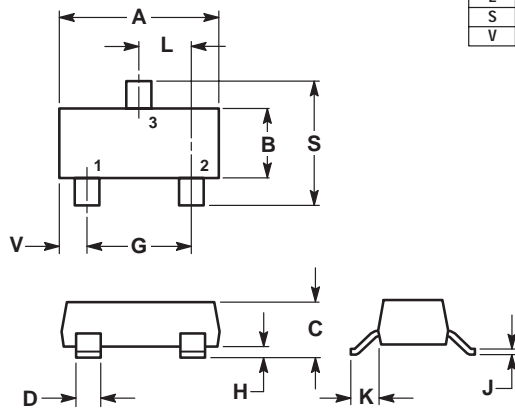
NOTES:

1. DIMENSIONING AND TOLERANCING PER ANSI Y14.5M, 1982.
2. CONTROLLING DIMENSION: INCH.
3. MAXIMUM LEAD THICKNESS INCLUDES LEAD FINISH THICKNESS. MINIMUM LEAD THICKNESS IS THE MINIMUM THICKNESS OF BASE MATERIAL.

DIM	INCHES		MILLIMETERS	
	MIN	MAX	MIN	MAX
A	0.1102	0.1197	2.80	3.04
B	0.0472	0.0551	1.20	1.40
C	0.0350	0.0440	0.89	1.11
D	0.0150	0.0200	0.37	0.50
G	0.0701	0.0807	1.78	2.04
H	0.0005	0.0040	0.013	0.100
J	0.0034	0.0070	0.085	0.177
K	0.0180	0.0236	0.45	0.60
L	0.0350	0.0401	0.89	1.02
S	0.0830	0.0984	2.10	2.50
V	0.0177	0.0236	0.45	0.60

STYLE 8:

- PIN 1. ANODE
- NO CONNECTION
- CATHODE



SOT-23 Footprint

CASE 318-07  
PLASTIC

(Refer to Section 10 for Surface Mount, Thermal Data and Footprint Information.)

### MULTIPLE PACKAGE QUANTITY (MPQ) REQUIREMENTS

Package Option	Type No. Suffix	MPQ (Units)
Tape and Reel	T1	3K
Tape and Ammo	T3	10K

(Refer to Section 10 for more information on Packaging Specifications.)

# GENERAL DATA — 225 mW SOT-23

**ELECTRICAL CHARACTERISTICS (Pinout: 1-Anode, 2-NC, 3-Cathode)** ( $V_F = 0.9\text{ V Max @ } I_F = 10\text{ mA}$  for all types.)

Device	Marking	Test Current $I_{ZT}$ mA	Zener Voltage $V_Z (\pm 5\%)$ Nominal (Note 1)	$Z_{ZK}$ $I_Z = 0.25\text{ mA}$ $\Omega$ Max	$Z_{ZT}$ $I_Z = I_{ZT}$ @ 10% Mod $\Omega$ Max	Max $I_R$ $\mu\text{A}$	@	$V_R$ V
MMBZ5221BLT1	18A	20	2.4	1200	30	100		1
MMBZ5222BLT1	18B	20	2.5	1250	30	100		1
MMBZ5223BLT1	18C	20	2.7	1300	30	75		1
MMBZ5224BLT1	18D	20	2.8	1400	30	75		1
MMBZ5225BLT1	18E	20	3	1600	29	50		1
MMBZ5226BLT1	8A	20	3.3	1600	28	25		1
MMBZ5227BLT1	8B	20	3.6	1700	24	15		1
MMBZ5228BLT1	8C	20	3.9	1900	23	10		1
MMBZ5229BLT1	8D	20	4.3	2000	22	5		1
MMBZ5230BLT1	8E	20	4.7	1900	19	5		2
<b>MMBZ5231BLT1</b>	<b>8F</b>	<b>20</b>	<b>5.1</b>	<b>1600</b>	<b>17</b>	<b>5</b>		<b>2</b>
<b>MMBZ5232BLT1</b>	<b>8G</b>	<b>20</b>	<b>5.6</b>	<b>1600</b>	<b>11</b>	<b>5</b>		<b>3</b>
MMBZ5233BLT1	8H	20	6	1600	7	5		3.5
<b>MMBZ5234BLT1</b>	<b>8J</b>	<b>20</b>	<b>6.2</b>	<b>1000</b>	<b>7</b>	<b>5</b>		<b>4</b>
<b>MMBZ5235BLT1</b>	<b>8K</b>	<b>20</b>	<b>6.8</b>	<b>750</b>	<b>5</b>	<b>3</b>		<b>5</b>
MMBZ5236BLT1	8L	20	7.5	500	6	3		6
MMBZ5237BLT1	8M	20	8.2	500	8	3		6.5
MMBZ5238BLT1	8N	20	8.7	600	8	3		6.5
MMBZ5239BLT1	8P	20	9.1	600	10	3		7
<b>MMBZ5240BLT1</b>	<b>8Q</b>	<b>20</b>	<b>10</b>	<b>600</b>	<b>17</b>	<b>3</b>		<b>8</b>
MMBZ5241BLT1	8R	20	11	600	22	2		8.4
<b>MMBZ5242BLT1</b>	<b>8S</b>	<b>20</b>	<b>12</b>	<b>600</b>	<b>30</b>	<b>1</b>		<b>9.1</b>
MMBZ5243BLT1	8T	9.5	13	600	13	0.5		9.9
MMBZ5244BLT1	8U	9	14	600	15	0.1		10
<b>MMBZ5245BLT1</b>	<b>8V</b>	<b>8.5</b>	<b>15</b>	<b>600</b>	<b>16</b>	<b>0.1</b>		<b>11</b>
MMBZ5246BLT1	8W	7.8	16	600	17	0.1		12
MMBZ5247BLT1	8X	7.4	17	600	19	0.1		13
<b>MMBZ5248BLT1</b>	<b>8Y</b>	<b>7</b>	<b>18</b>	<b>600</b>	<b>21</b>	<b>0.1</b>		<b>14</b>
MMBZ5249BLT1	8Z	6.6	19	600	23	0.1		14
<b>MMBZ5250BLT1</b>	<b>81A</b>	<b>6.2</b>	<b>20</b>	<b>600</b>	<b>25</b>	<b>0.1</b>		<b>15</b>
MMBZ5251BLT1	81B	5.6	22	600	29	0.1		17
MMBZ5252BLT1	81C	5.2	24	600	33	0.1		18
MMBZ5253BLT1	81D	5	25	600	35	0.1		19
<b>MMBZ5254BLT1</b>	<b>81E</b>	<b>4.6</b>	<b>27</b>	<b>600</b>	<b>41</b>	<b>0.1</b>		<b>21</b>
MMBZ5255BLT1	81F	4.5	28	600	44	0.1		21
MMBZ5256BLT1	81G	4.2	30	600	49	0.1		23
<b>MMBZ5257BLT1</b>	<b>81H</b>	<b>3.8</b>	<b>33</b>	<b>700</b>	<b>58</b>	<b>0.1</b>		<b>25</b>
MMBZ5258BLT1	81J	3.4	36	700	70	0.1		27
MMBZ5259BLT1	81K	3.2	39	800	80	0.1		30
MMBZ5260BLT1	18F	3	43	900	93	0.1		33
MMBZ5261BLT1	81M	2.7	47	1000	105	0.1		36
MMBZ5262BLT1	81N	2.5	51	1100	125	0.1		39
MMBZ5263BLT1	81P	2.2	56	1300	150	0.1		43
MMBZ5264BLT1	81Q	2.1	60	1400	170	0.1		46
MMBZ5265BLT1	81R	2	62	1400	185	0.1		47
MMBZ5266BLT1	81S	1.8	68	1600	230	0.1		52
MMBZ5267BLT1	81T	1.7	75	1700	270	0.1		56
MMBZ5268BLT1	81U	1.5	82	2000	330	0.1		62
MMBZ5269BLT1	81V	1.4	87	2200	370	0.1		68
MMBZ5270BLT1	81W	1.4	91	2300	400	0.1		69

NOTE 1. Zener voltage is measured with a pulse test current ( $I_{ZT}$ ) applied at an ambient temperature of 25°C.

*Designer's™ Data Sheet*  
**Surface Mount Silicon Zener Diodes**  
**Plastic SOD-123 Package**

Three complete series of Zener Diodes are offered in the convenient, surface mount plastic SOD-123 package. These devices provide a convenient alternative to the leadless 34 package style.

- 500 mW Rating on FR-4 or FR-5 Board
- Package Designed for Optimal Automated Board Assembly
- Corrosion Resistant Finish, Easily Solderable
- ESD Rating of Class 3 (exceeding 16 kV) per the Human Body Model
- Small Package Size for High Density Applications
- Available in 8 mm Tape and Reel  
 Add "T1" to the device number to order the 7 inch/3000 unit reel.  
 Add "T3" to the device number to order the 13 inch/10,000 unit reel.
- Wafer Fab Location: Phoenix, Arizona  
 Assembly/Test Location: Seremban, Malaysia

**MMSZ5221BT1 thru MMSZ5270BT1**

- General Purpose, Medium Current
- Wide Voltage Range — 2.4 to 91 Volts

**MMSZ4678T1 thru MMSZ4717T1**

- Low Operating Currents, Low Leakage, Sharp Breakdown Characteristics
- Wide Voltage Range — 1.8 to 43 Volts

**MMSZ2V4T1 thru MMSZ75T1**

- Specified Similar to European BZV55C Series
- Wide Voltage Range — 2.4 to 75 Volts

**MMSZ5221BT1 -**  
**MMSZ5270BT1\***  
**MMSZ4678T1 -**  
**MMSZ4717T1**  
**MMSZ2V4T1 -**  
**MMSZ75T1**

\*Motorola Preferred Device Series

**PLASTIC SURFACE  
MOUNT  
ZENER DIODES  
500 MILLIWATTS  
1.8-91 VOLTS**



1: CATHODE  
2: ANODE



**CASE 425, STYLE 1  
PLASTIC**

**DEVICE RATING** ( $T_A = 25^\circ\text{C}$  unless otherwise noted)

Rating	Symbol	Value	Unit
Power Dissipation on FR-4 or FR-5 Board [1] Derate above $T_L = 75^\circ\text{C}$	$P_D$ —	500 6.7	mW mW/°C
Thermal Resistance Junction to Lead [2] Thermal Resistance Junction to Ambient [2]	$R_{\theta JL}$ $R_{\theta JA}$	150 340	°C/W
Junction Temperature Range	$T_J$	-55 to +150	°C
Storage Temperature Range	$T_{stg}$	-55 to +150	°C
Lead Solder Temperature – Maximum (10 sec. duration)	—	260	°C

[1] FR-4 or FR-5 = 3.5 x 1.5 inches, using the Motorola minimum recommended footprint as shown in Figure 11.

[2] Thermal Resistance measurement obtained via Infrared Scan Method

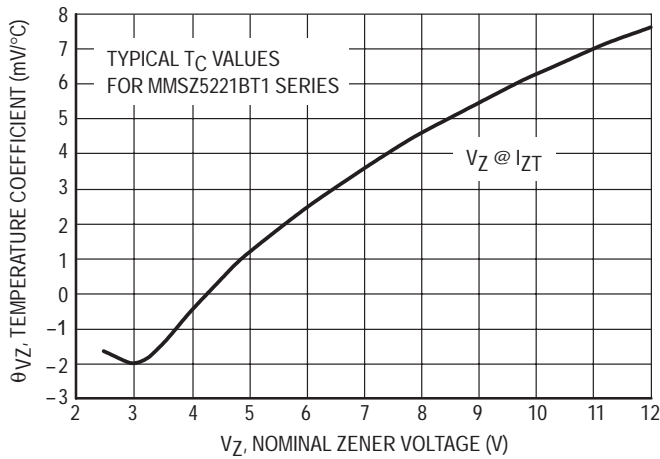
**Designer's Data for "Worst Case" Conditions** — The Designer's Data Sheet permits the design of most circuits entirely from the information presented. Limit curves — representing boundaries on device characteristics — are given to facilitate "worst case" design.

Designer's is a trademark of Motorola, Inc.  
Thermal Clad is a trademark of the Bergquist Company.

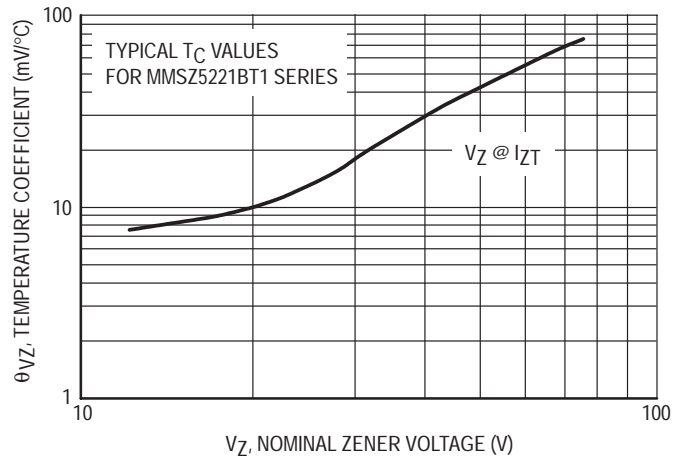
**Preferred** devices are Motorola recommended choices for future use and best overall value.

# MMSZ5221BT1, MMSZ4678T1, MMSZ2V4T1 Series

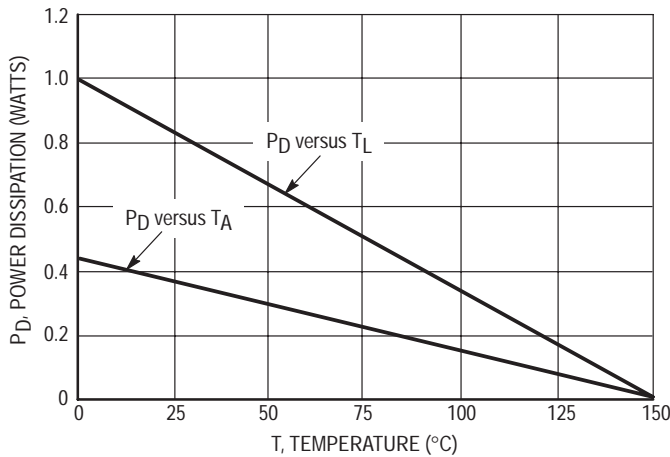
## TYPICAL CHARACTERISTICS



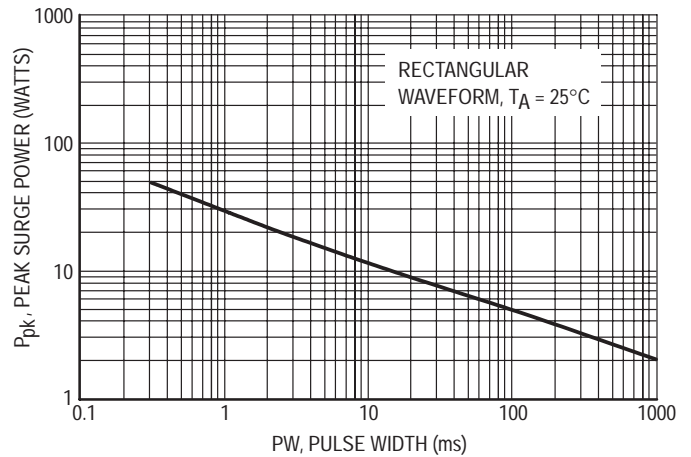
**Figure 1. Temperature Coefficients (Temperature Range -55°C to +150°C)**



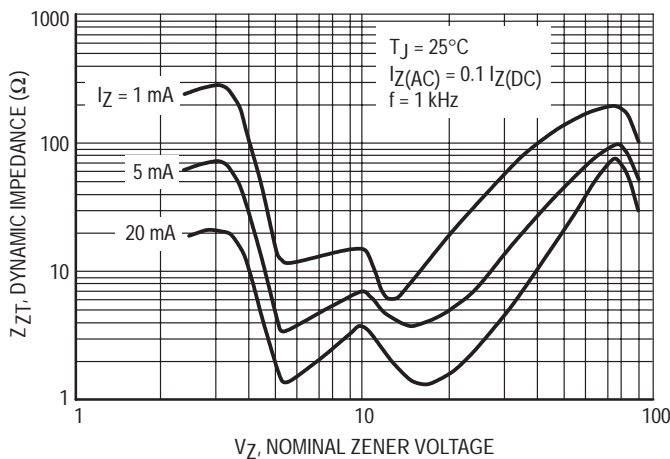
**Figure 2. Temperature Coefficients (Temperature Range -55°C to +150°C)**



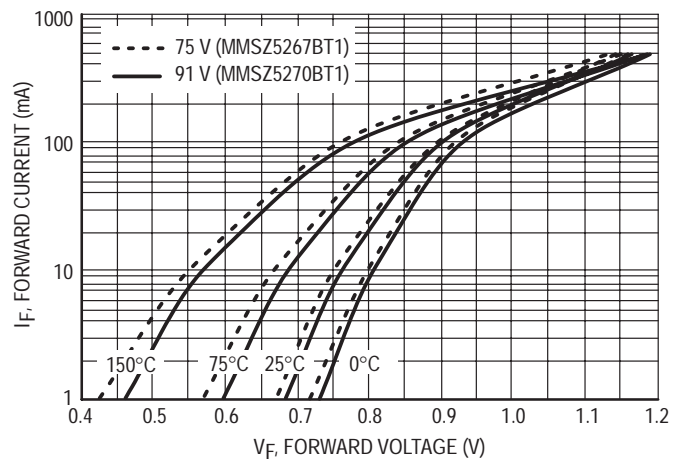
**Figure 3. Steady State Power Derating**



**Figure 4. Maximum Nonrepetitive Surge Power**



**Figure 5. Effect of Zener Voltage on Zener Impedance**



**Figure 6. Typical Forward Voltage**



# MMSZ5221BT1, MMSZ4678T1, MMSZ2V4T1 Series

## TYPICAL CHARACTERISTICS

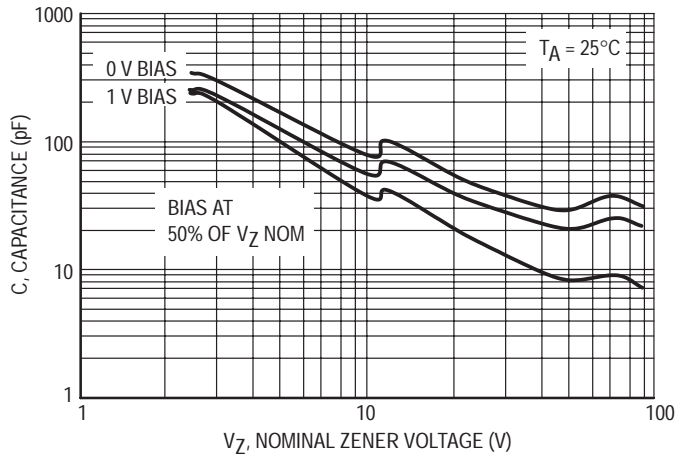


Figure 7. Typical Capacitance

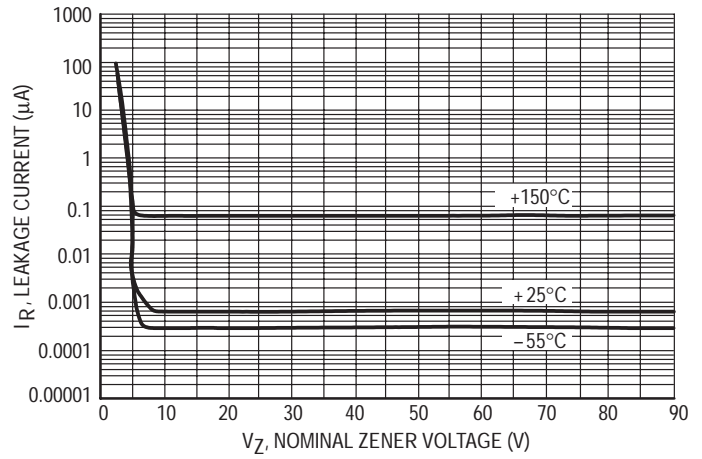


Figure 8. Typical Leakage Current

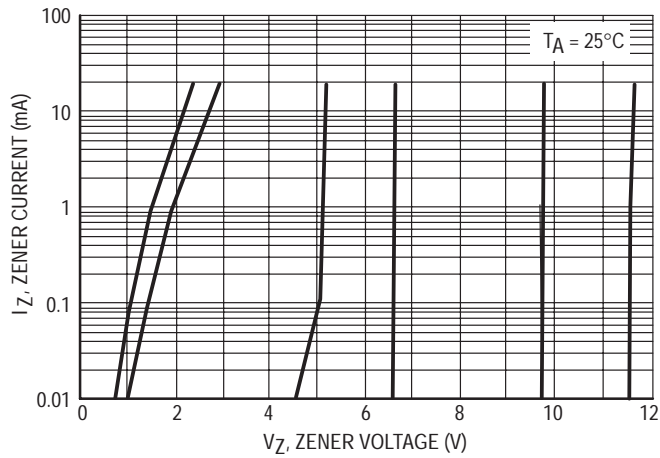


Figure 9. Zener Voltage versus Zener Current  
( $V_Z$  Up to 12 V)

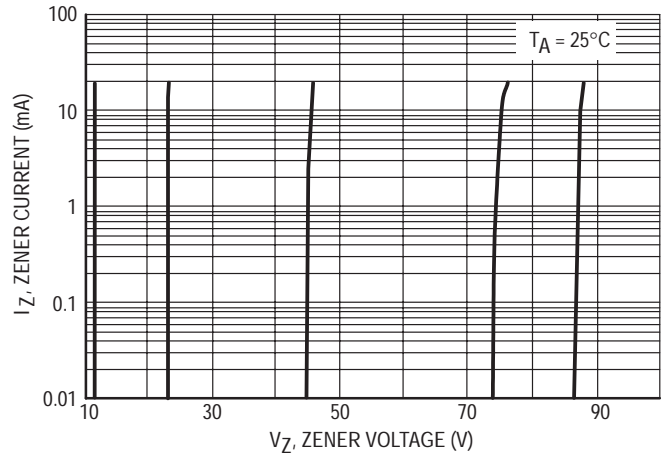


Figure 10. Zener Voltage versus Zener Current  
(12 V to 91 V)

# MMSZ5221BT1, MMSZ4678T1, MMSZ2V4T1 Series

**ELECTRICAL CHARACTERISTICS** ( $T_A = 25^\circ\text{C}$  unless otherwise noted <sup>[1]</sup>), ( $V_F = 0.9\text{ V Max. @ } I_F = 10\text{ mA}$  for all types)

Type Number	Marking	Zener Voltage $V_Z @ I_{ZT}$ Volts [1] [2]			Test Current $I_{ZT}$ mA	Max Zener Impedance [3]		Max Reverse Leakage Current $I_R @ V_R$ $\mu\text{A}$	Test Voltage $V_R$ Volts
		Nom	Min	Max		$Z_{ZT} @ I_Z = I_{ZT}$ $\Omega$	$Z_{ZK} @ I_{ZK} = 0.25\text{ mA}$ $\Omega$		
<b>MMSZ5221BT1</b>	C1	2.4	2.28	2.52	20	30	1200	100	1
<b>MMSZ5222BT1</b>	C2	2.5	2.38	2.63	20	30	1250	100	1
MMSZ5223BT1	C3	2.7	2.57	2.84	20	30	1300	75	1
MMSZ5224BT1	C4	2.8	2.66	2.94	20	30	1400	75	1
<b>MMSZ5225BT1</b>	C5	3.0	2.85	3.15	20	30	1600	50	1
MMSZ5226BT1	D1	3.3	3.14	3.47	20	28	1600	25	1
MMSZ5227BT1	D2	3.6	3.42	3.78	20	24	1700	15	1
MMSZ5228BT1	D3	3.9	3.71	4.10	20	23	1900	10	1
<b>MMSZ5229BT1</b>	D4	4.3	4.09	4.52	20	22	2000	5	1
<b>MMSZ5230BT1</b>	D5	4.7	4.47	4.94	20	19	1900	5	2
<b>MMSZ5231BT1</b>	E1	5.1	4.85	5.36	20	17	1600	5	2
<b>MMSZ5232BT1</b>	E2	5.6	5.32	5.88	20	11	1600	5	3
MMSZ5233BT1	E3	6.0	5.70	6.30	20	7	1600	5	3.5
<b>MMSZ5234BT1</b>	E4	6.2	5.89	6.51	20	7	1000	5	4
MMSZ5235BT1	E5	6.8	6.46	7.14	20	5	750	3	5
MMSZ5236BT1	F1	7.5	7.13	7.88	20	6	500	3	6
MMSZ5237BT1	F2	8.2	7.79	8.61	20	8	500	3	6.5
MMSZ5238BT1	F3	8.7	8.27	9.14	20	8	600	3	6.5
MMSZ5239BT1	F4	9.1	8.65	9.56	20	10	600	3	7
<b>MMSZ5240BT1</b>	F5	10	9.50	10.50	20	17	600	3	8
MMSZ5241BT1	H1	11	10.45	11.55	20	22	600	2	8.4
<b>MMSZ5242BT1</b>	H2	12	11.40	12.60	20	30	600	1	9.1
MMSZ5243BT1	H3	13	12.35	13.65	9.5	13	600	0.5	9.9
MMSZ5244BT1	H4	14	13.30	14.70	9.0	15	600	0.1	10
<b>MMSZ5245BT1</b>	H5	15	14.25	15.75	8.5	16	600	0.1	11
<b>MMSZ5246BT1</b>	J1	16	15.20	16.80	7.8	17	600	0.1	12
MMSZ5247BT1	J2	17	16.15	17.85	7.4	19	600	0.1	13
<b>MMSZ5248BT1</b>	J3	18	17.10	18.90	7.0	21	600	0.1	14
MMSZ5249BT1	J4	19	18.05	19.95	6.6	23	600	0.1	14
MMSZ5250BT1	J5	20	19.00	21.00	6.2	25	600	0.1	15
MMSZ5251BT1	K1	22	20.90	23.10	5.6	29	600	0.1	17
<b>MMSZ5252BT1</b>	K2	24	22.80	25.20	5.2	33	600	0.1	18
MMSZ5253BT1	K3	25	23.75	26.25	5.0	35	600	0.1	19
MMSZ5254BT1	K4	27	25.65	28.35	4.6	41	600	0.1	21
MMSZ5255BT1	K5	28	26.60	29.40	4.5	44	600	0.1	21

[1] Nominal zener voltage is measured with the device junction in thermal equilibrium at  $T_L = 30^\circ\text{C} \pm 1^\circ\text{C}$ .

[2] All part numbers shown indicate a  $V_Z$  tolerance of  $\pm 5\%$ .

[3]  $Z_{ZT}$  and  $Z_{ZK}$  are measured by dividing the AC voltage drop across the device by the AC current applied. The specified limits are for  $I_{Z(AC)} = 0.1 I_{Z(DC)}$ , with the AC frequency = 1 kHz.

# MMSZ5221BT1, MMSZ4678T1, MMSZ2V4T1 Series

**ELECTRICAL CHARACTERISTICS** ( $T_A = 25^\circ\text{C}$  unless otherwise noted [1]), ( $V_F = 0.9\text{ V Max. @ } I_F = 10\text{ mA}$  for all types)

Type Number	Marking	Zener Voltage $V_Z @ I_{ZT}$ Volts [1] [2]			Test Current $I_{ZT}$ mA	Max Zener Impedance [3]		Max Reverse Leakage Current $I_R @ V_R$ $\mu\text{A}$	Test Voltage $V_R$ Volts
		Nom	Min	Max		$Z_{ZT}$ @ $I_Z = I_{ZT}$ $\Omega$	$Z_{ZK}$ @ $I_{ZK} = 0.25\text{ mA}$ $\Omega$		
<b>MMSZ5256BT1</b>	M1	30	28.50	31.50	4.2	49	600	0.1	23
MMSZ5257BT1	M2	33	31.35	34.65	3.8	58	700	0.1	25
MMSZ5258BT1	M3	36	34.20	37.80	3.4	70	700	0.1	27
MMSZ5259BT1	M4	39	37.05	40.95	3.2	80	800	0.1	30
MMSZ5260BT1	M5	43	40.85	45.15	3.0	93	900	0.1	33
<b>MMSZ5261BT1</b>	N1	47	44.65	49.35	2.7	105	1000	0.1	36
MMSZ5262BT1	N2	51	48.45	53.55	2.5	125	1100	0.1	39
MMSZ5263BT1	N3	56	53.20	58.80	2.2	150	1300	0.1	43
MMSZ5264BT1	N4	60	57.00	63.00	2.1	170	1400	0.1	46
MMSZ5265BT1	N5	62	58.90	65.10	2.0	185	1400	0.1	47
MMSZ5266BT1	P1	68	64.60	71.40	1.8	230	1600	0.1	52
MMSZ5267BT1	P2	75	71.25	78.75	1.7	270	1700	0.1	56
MMSZ5268BT1	P3	82	77.90	86.10	1.5	330	2000	0.1	62
MMSZ5269BT1	P4	87	82.65	91.35	1.4	370	2200	0.1	68
MMSZ5270BT1	P5	91	86.45	95.55	1.4	400	2300	0.1	69

[1] Nominal zener voltage is measured with the device junction in thermal equilibrium at  $T_L = 30^\circ\text{C} \pm 1^\circ\text{C}$ .

[2] All part numbers shown indicate a  $V_Z$  tolerance of  $\pm 5\%$ .

[3]  $Z_{ZT}$  and  $Z_{ZK}$  are measured by dividing the AC voltage drop across the device by the AC current applied. The specified limits are for  $I_{Z(AC)} = 0.1 I_{Z(DC)}$ , with the AC frequency = 1 kHz.

# MMSZ5221BT1, MMSZ4678T1, MMSZ2V4T1 Series

**ELECTRICAL CHARACTERISTICS** ( $T_A = 25^\circ\text{C}$  unless otherwise noted [1], ( $V_F = 0.9\text{ V Max. @ } I_F = 10\text{ mA}$  for all types)

Type Number	Marking	Zener Voltage $V_Z @ I_{ZT} = 50\ \mu\text{A}$ Volts [1] [2]			Max Reverse Leakage Current $I_R @ V_R$ $\mu\text{A}$	Test Voltage $V_R$ Volts
		Nom	Min	Max		
MMSZ4678T1	CC	1.8	1.71	1.89	7.5	1
MMSZ4679T1	CD	2.0	1.90	2.10	5	1
<b>MMSZ4680T1</b>	CE	2.2	2.09	2.31	4	1
MMSZ4681T1	CF	2.4	2.28	2.52	2	1
MMSZ4682T1	CH	2.7	2.57	2.84	1	1
MMSZ4683T1	CJ	3.0	2.85	3.15	0.8	1
MMSZ4684T1	CK	3.3	3.14	3.47	7.5	1.5
<b>MMSZ4685T1</b>	CM	3.6	3.42	3.78	7.5	2
MMSZ4686T1	CN	3.9	3.71	4.10	5	2
MMSZ4687T1	CP	4.3	4.09	4.52	4	2
MMSZ4688T1	CT	4.7	4.47	4.94	10	3
MMSZ4689T1	CU	5.1	4.85	5.36	10	3
<b>MMSZ4690T1</b>	CV	5.6	5.32	5.88	10	4
MMSZ4691T1	CA	6.2	5.89	6.51	10	5
MMSZ4692T1	CX	6.8	6.46	7.14	10	5.1
MMSZ4693T1	CY	7.5	7.13	7.88	10	5.7
MMSZ4694T1	CZ	8.2	7.79	8.61	1	6.2
MMSZ4695T1	DC	8.7	8.27	9.14	1	6.6
MMSZ4696T1	DD	9.1	8.65	9.56	1	6.9
MMSZ4697T1	DE	10	9.50	10.50	1	7.6
MMSZ4698T1	DF	11	10.45	11.55	0.05	8.4
MMSZ4699T1	DH	12	11.40	12.60	0.05	9.1
MMSZ4700T1	DJ	13	12.35	13.65	0.05	9.8
MMSZ4701T1	DK	14	13.30	14.70	0.05	10.6
MMSZ4702T1	DM	15	14.25	15.75	0.05	11.4
MMSZ4703T1	DN	16	15.20	16.80	0.05	12.1
MMSZ4704T1	DP	17	16.15	17.85	0.05	12.9
MMSZ4705T1	DT	18	17.10	18.90	0.05	13.6
MMSZ4706T1	DU	19	18.05	19.95	0.05	14.4
MMSZ4707T1	DV	20	19.00	21.00	0.01	15.2
MMSZ4708T1	DA	22	20.90	23.10	0.01	16.7
MMSZ4709T1	DZ	24	22.80	25.20	0.01	18.2
MMSZ4710T1	DY	25	23.75	26.25	0.01	19.00
MMSZ4711T1	EA	27	25.65	28.35	0.01	20.4
MMSZ4712T1	EC	28	26.60	29.40	0.01	21.2
MMSZ4713T1	ED	30	28.50	31.50	0.01	22.8
MMSZ4714T1	EE	33	31.35	34.65	0.01	25.0
MMSZ4715T1	EF	36	34.20	37.80	0.01	27.3
MMSZ4716T1	EH	39	37.05	40.95	0.01	29.6
MMSZ4717T1	EJ	43	40.85	45.15	0.01	32.6

[1] Nominal zener voltage is measured with the device junction in thermal equilibrium at  $T_L = 30^\circ\text{C} \pm 1^\circ\text{C}$ .

[2] All part numbers shown indicate a  $V_Z$  tolerance of  $\pm 5\%$

# MMSZ5221BT1, MMSZ4678T1, MMSZ2V4T1 Series

**ELECTRICAL CHARACTERISTICS** ( $T_A = 25^\circ\text{C}$  unless otherwise noted), ( $V_F = 0.9\text{ V Max. @ } I_F = 10\text{ mA}$  for all types)

Type Number	Marking	Zener Voltage $V_{Z1}$ (Volts) @ $I_{ZT1} = 5\text{ mA}$ [1][2]			Max Zener Impedance $Z_{ZT1}$ @ $I_{ZT1} = 5\text{ mA}$ [3] $\Omega$	Max Reverse Leakage Current		Zener Voltage $V_{Z2}$ (Volts) @ $I_{ZT2} = 1\text{ mA}$ [1]		Max Zener Impedance $Z_{ZT2}$ @ $I_{ZT1} = 1\text{ mA}$ [3] $\Omega$
		Nom	Min	Max		$I_R$ $\mu\text{A}$	@ $V_R$ Volts	Min	Max	
MMSZ2V4T1	T1	2.4	2.28	2.52	100	50	1	1.7	2.1	600
MMSZ2V7T1	T2	2.7	2.57	2.84	100	20	1	1.9	2.4	600
MMSZ3V0T1	T3	3.0	2.85	3.15	95	10	1	2.1	2.7	600
MMSZ3V3T1	T4	3.3	3.14	3.47	95	5	1	2.3	2.9	600
MMSZ3V6T1	T5	3.6	3.42	3.78	90	5	1	2.7	3.3	600
MMSZ3V9T1	U1	3.9	3.71	4.10	90	3	1	2.9	3.5	600
MMSZ4V3T1	U2	4.3	4.09	4.52	90	3	1	3.3	4.0	600
MMSZ4V7T1	U3	4.7	4.47	4.94	80	3	2	3.7	4.7	500
<b>MMSZ5V1T1</b>	U4	5.1	4.85	5.36	60	2	2	4.2	5.3	480
<b>MMSZ5V6T1</b>	U5	5.6	5.32	5.88	40	1	2	4.8	6.0	400
<b>MMSZ6V2T1</b>	V1	6.2	5.89	6.51	10	3	4	5.6	6.6	150
MMSZ6V8T1	V2	6.8	6.46	7.14	15	2	4	6.3	7.2	80
MMSZ7V5T1	V3	7.5	7.13	7.88	15	1	5	6.9	7.9	80
MMSZ8V2T1	V4	8.2	7.79	8.61	15	0.7	5	7.6	8.7	80
MMSZ9V1T1	V5	9.1	8.65	9.56	15	0.5	6	8.4	9.6	100
MMSZ10T1	A1	10	9.50	10.50	20	0.2	7	9.3	10.6	150
MMSZ11T1	A2	11	10.45	11.55	20	0.1	8	10.2	11.6	150
MMSZ12T1	A3	12	11.40	12.60	25	0.1	8	11.2	12.7	150
MMSZ13T1	A4	13	12.35	13.65	30	0.1	8	12.3	14.0	170
MMSZ15T1	A5	15	14.25	15.75	30	0.05	10.5	13.7	15.5	200
MMSZ16T1	X1	16	15.20	16.80	40	0.05	11.2	15.2	17.0	200
<b>MMSZ18T1</b>	X2	18	17.10	18.90	45	0.05	12.6	16.7	19.0	225
MMSZ20T1	X3	20	19.00	21.00	55	0.05	14	18.7	21.1	225
MMSZ22T1	X4	22	20.80	23.10	55	0.05	15.4	20.7	23.2	250
MMSZ24T1	X5	24	22.80	25.20	70	0.05	16.8	22.7	25.5	250

Type Number	Marking	Zener Voltage $V_{Z1}$ (Volts) @ $I_{ZT1} = 2\text{ mA}$ [1][2]			Max Zener Impedance $Z_{ZT1}$ @ $I_{ZT1} = 2\text{ mA}$ [3] $\Omega$	Max Reverse Leakage Current		Zener Voltage $V_{Z2}$ (Volts) @ $I_{ZT2} = 0.1\text{ mA}$ [1]		Max Zener Impedance $Z_{ZT2}$ @ $I_{ZT1} = 0.5\text{ mA}$ [3][4] $\Omega$
		Nom	Min	Max		$I_R$ $\mu\text{A}$	@ $V_R$ Volts	Min	Max	
MMSZ27T1	Y1	27	25.65	28.35	80	0.05	18.9	25	28.9	300
MMSZ30T1	Y2	30	28.50	31.50	80	0.05	21	27.8	32	300
MMSZ33T1	Y3	33	31.35	34.65	80	0.05	23.1	30.8	35	325
MMSZ36T1	Y4	36	34.20	37.80	90	0.05	25.2	33.8	38	350
<b>MMSZ39T1</b>	Y5	39	37.05	40.95	130	0.05	27.3	36.7	41	350
MMSZ43T1	Z1	43	40.85	45.15	150	0.05	30.1	39.7	46	375
MMSZ47T1	Z2	47	44.65	49.35	170	0.05	32.9	43.7	50	375
MMSZ51T1	Z3	51	48.45	53.55	180	0.05	35.7	47.6	54	400
MMSZ56T1	Z4	56	53.20	58.80	200	0.05	39.2	51.5	60	425
MMSZ62T1	Z5	62	58.90	65.10	215	0.05	43.4	57.4	66	450
MMSZ68T1	Z6	68	64.60	71.40	240	0.05	47.6	63.4	72	475
MMSZ75T1	Z7	75	71.25	78.75	255	0.05	52.5	69.4	79	500

[1] Zener voltage is measured with the zener current applied for  $PW = 1.0\text{ ms}$ .

[2] All part numbers shown indicate a  $V_Z$  tolerance of  $\pm 5\%$ .

[3]  $Z_{ZT1}$  and  $Z_{ZT2}$  are measured by dividing the AC voltage drop across the device by the AC current applied. The specified limits are for  $I_{Z(AC)} = 0.1 I_{Z(DC)}$ , with the AC frequency = 1 kHz.

[4] The zener impedance,  $Z_{ZT2}$ , for the 27 through 75 volt types is tested at 0.5 mA rather than the test current of 0.1 mA used for  $V_{Z2}$ .

# MMSZ5221BT1, MMSZ4678T1, MMSZ2V4T1 Series

## INFORMATION FOR USING THE SOD-123 SURFACE MOUNT PACKAGE

### MINIMUM RECOMMENDED FOOTPRINTS FOR SURFACE MOUNT APPLICATIONS

Surface mount board layout is a critical portion of the total design. The footprint for the semiconductor packages must be the correct size to ensure proper solder connection interface between the board and the package.

The minimum recommended footprint for the SOD-123 is shown at the right.

The SOD-123 package can be used on existing surface mount boards which have been designed for the leadless 34 package style. The footprint compatibility makes conversion from leadless 34 to SOD-123 straightforward.

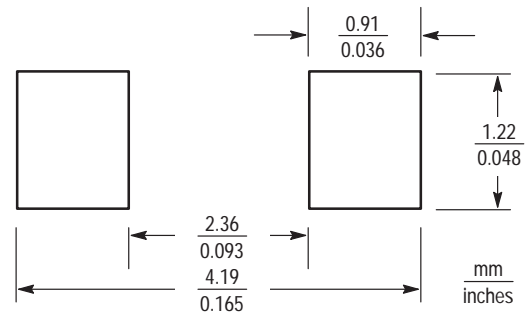


Figure 11. Minimum Recommended Footprint

### SOD-123 POWER DISSIPATION

The power dissipation of the SOD-123 is a function of the pad size. This can vary from the minimum pad size for soldering to a pad size given for maximum power dissipation. Power dissipation for a surface mount device is determined by  $T_{J(max)}$ , the maximum rated junction temperature of the die,  $R_{\theta JA}$ , the thermal resistance from the device junction to ambient; and the operating temperature,  $T_A$ . Using the values provided on the data sheet for the SOD-123 package,  $P_D$  can be calculated as follows:

$$P_D = \frac{T_{J(max)} - T_A}{R_{\theta JA}}$$

The values for the equation are found in the maximum

ratings table on the data sheet. Substituting these values into the equation for an ambient temperature  $T_A$  of 25°C, one can calculate the power dissipation of the device which in this case is 0.37 watts.

$$P_D = \frac{150^\circ\text{C} - 25^\circ\text{C}}{340^\circ\text{C/W}} = 0.37 \text{ watts}$$

The 340°C/W for the SOD-123 package assumes using recommended footprint shown on FR-4 glass epoxy printed circuit board. Another alternative is to use a ceramic substrate or an aluminum core board such as Thermal Clad™. By using an aluminum core board material such as Thermal Clad, the power dissipation can be doubled using the same footprint.

### GENERAL SOLDERING PRECAUTIONS

The melting temperature of solder is higher than the rated temperature of the device. When the entire device is heated to a high temperature, failure to complete soldering within a short time could result in device failure. Therefore, the following items should always be observed in order to minimize the thermal stress to which the devices are subjected.

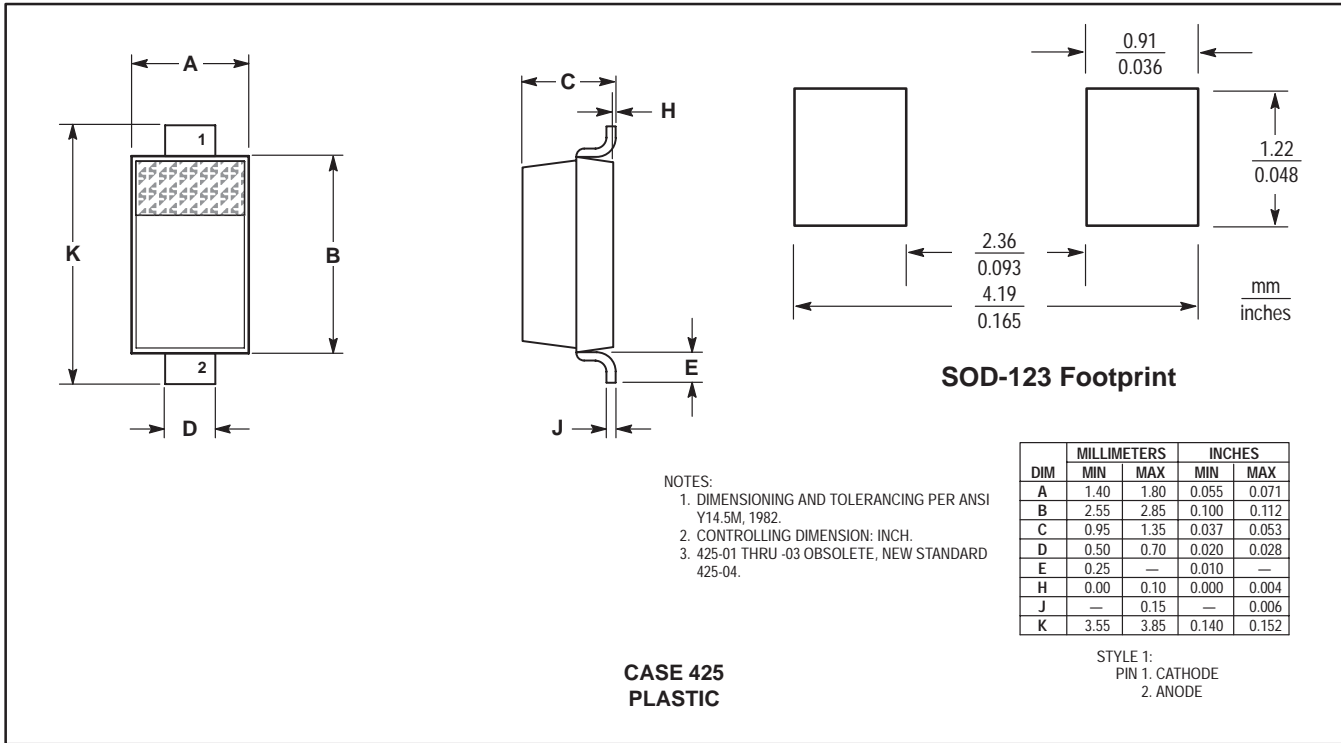
- Always preheat the device.
- The delta temperature between the preheat and soldering should be 100°C or less.\*
- When preheating and soldering, the temperature of the leads and the case must not exceed the maximum temperature ratings as shown on the data sheet. When using infrared heating with the reflow soldering method, the difference shall be a maximum of 10°C.

- The soldering temperature and time shall not exceed 260°C for more than 10 seconds.
- When shifting from preheating to soldering, the maximum temperature gradient shall be 5°C or less.
- After soldering has been completed, the device should be allowed to cool naturally for at least three minutes. Gradual cooling should be used as the use of forced cooling will increase the temperature gradient and result in latent failure due to mechanical stress.
- Mechanical stress or shock should not be applied during cooling

\* Soldering a device without preheating can cause excessive thermal shock and stress which can result in damage to the device.

# Zener Voltage Regulator Diodes — Surface Mounted

## 500 mW SOD-123



(Refer to Section 10 for Surface Mount, Thermal Data and Footprint Information.)

### MULTIPLE PACKAGE QUANTITY (MPQ) REQUIREMENTS

Package Option	Type No. Suffix	MPQ (Units)
Tape and Reel	T1(1)	3K
Tape and Reel	T3(2)	10K

NOTE: 1. The numbers on the suffixes indicate the following:

1. 7" Reel. Cathode lead toward sprocket hole.
2. 13" Reel. Cathode lead toward sprocket hole.

(Refer to Section 10 for more information on Packaging Specifications.)

## 3 Watt Plastic Surface Mount Silicon Zener Diodes

**1SMB5913BT3  
through  
1SMB5956BT3**

This complete new line of 3 Watt Zener Diodes offers the following advantages.

### Specification Features:

- A Complete Voltage Range — 3.3 to 200 Volts
- Flat Handling Surface for Accurate Placement
- Package Design for Top Side or Bottom Circuit Board Mounting
- Available in Tape and Reel

### Mechanical Characteristics:

**CASE:** Void-free, transfer-molded plastic

**MAXIMUM CASE TEMPERATURE FOR SOLDERING PURPOSES:** 260°C for 10 seconds

**FINISH:** All external surfaces are corrosion resistant with readily solderable leads

**POLARITY:** Cathode indicated by molded polarity notch. When operated in zener mode, cathode will be positive with respect to anode.

**MOUNTING POSITION:** Any

**WEIGHT:** Modified L-Bend providing more contact area to bond pad

**WAFER FAB LOCATION:** Phoenix, Arizona

**ASSEMBLY/TEST LOCATION:** Seremban, Malaysia

**PLASTIC SURFACE MOUNT  
ZENER DIODES  
3 WATTS  
3.3–200 VOLTS**



**CASE 403A  
PLASTIC**

### MAXIMUM RATINGS

Rating	Symbol	Value	Unit
DC Power Dissipation @ $T_L = 75^\circ\text{C}$ , Measured at Zero Lead Length Derate above $75^\circ\text{C}$	$P_D$	3 40	Watts $\text{mW}/^\circ\text{C}$
DC Power Dissipation @ $T_A = 25^\circ\text{C}^*$ Derate above $25^\circ\text{C}$	$P_D$	830 6.6	mW $\text{mW}/^\circ\text{C}$
Operating and Storage Junction Temperature Range	$T_J, T_{stg}$	- 65 to +150	$^\circ\text{C}$

\*FR4 Board, within 1" to device, using Motorola minimum recommended footprint, as shown in case 403A outline dimensions spec.

### ELECTRICAL CHARACTERISTICS ( $T_L = 30^\circ\text{C}$ unless otherwise noted.) ( $V_F = 1.5$ Volts Max @ $I_F = 200$ mAdc for all types.)

Device*	Nominal Zener Voltage $V_Z$ @ $I_{ZT}$ Volts (Note 1)	Test Current $I_{ZT}$ mA	Max Zener Impedance (Note 2)			Max Reverse Leakage Current		Maximum DC Zener Current $I_{ZM}$ mAdc	Device Marking
			$Z_{ZT}$ @ $I_{ZT}$ Ohms	$Z_{ZK}$ Ohms @	$I_{ZK}$ mA	$I_R$ @ $V_R$ $\mu\text{A}$ Volts			
1SMB5913BT3	3.3	113.6	10	500	1	100	1	454	913B
1SMB5914BT3	3.6	104.2	9	500	1	75	1	416	914B
<b>1SMB5915BT3</b>	<b>3.9</b>	<b>96.1</b>	<b>7.5</b>	<b>500</b>	<b>1</b>	<b>25</b>	<b>1</b>	<b>384</b>	<b>915B</b>
<b>1SMB5916BT3</b>	<b>4.3</b>	<b>87.2</b>	<b>6</b>	<b>500</b>	<b>1</b>	<b>5</b>	<b>1</b>	<b>348</b>	<b>916B</b>
<b>1SMB5917BT3</b>	<b>4.7</b>	<b>79.8</b>	<b>5</b>	<b>500</b>	<b>1</b>	<b>5</b>	<b>1.5</b>	<b>319</b>	<b>917B</b>
<b>1SMB5918BT3</b>	<b>5.1</b>	<b>73.5</b>	<b>4</b>	<b>350</b>	<b>1</b>	<b>5</b>	<b>2</b>	<b>294</b>	<b>918B</b>
<b>1SMB5919BT3</b>	<b>5.6</b>	<b>66.9</b>	<b>2</b>	<b>250</b>	<b>1</b>	<b>5</b>	<b>3</b>	<b>267</b>	<b>919B</b>
<b>1SMB5920BT3</b>	<b>6.2</b>	<b>60.5</b>	<b>2</b>	<b>200</b>	<b>1</b>	<b>5</b>	<b>4</b>	<b>241</b>	<b>920B</b>
1SMB5921BT3	6.8	55.1	2.5	200	1	5	5.2	220	921B
1SMB5922BT3	7.5	50	3	400	0.5	5	6.8	200	922B
<b>1SMB5923BT3</b>	<b>8.2</b>	<b>45.7</b>	<b>3.5</b>	<b>400</b>	<b>0.5</b>	<b>5</b>	<b>6.5</b>	<b>182</b>	<b>923B</b>
1SMB5924BT3	9.1	41.2	4	500	0.5	5	7	164	924B
<b>1SMB5925BT3</b>	<b>10</b>	<b>37.5</b>	<b>4.5</b>	<b>500</b>	<b>0.25</b>	<b>5</b>	<b>8</b>	<b>150</b>	<b>925B</b>
<b>1SMB5926BT3</b>	<b>11</b>	<b>34.1</b>	<b>5.5</b>	<b>550</b>	<b>0.25</b>	<b>1</b>	<b>8.4</b>	<b>136</b>	<b>926B</b>
<b>1SMB5927BT3</b>	<b>12</b>	<b>31.2</b>	<b>6.5</b>	<b>550</b>	<b>0.25</b>	<b>1</b>	<b>9.1</b>	<b>125</b>	<b>927B</b>
1SMB5928BT3	13	28.8	7	550	0.25	1	9.9	115	928B

(continued)

\*TOLERANCE AND VOLTAGE DESIGNATION Tolerance designation — The type numbers listed indicate a tolerance of  $\pm 5\%$ .

Devices listed in bold, italic are Motorola preferred devices.



# 1SMB5913BT3 Series

**ELECTRICAL CHARACTERISTICS — continued** ( $T_L = 30^\circ\text{C}$  unless otherwise noted.) ( $V_F = 1.5$  Volts Max @  $I_F = 200$  mAdc for all types.)

Device*	Nominal Zener Voltage $V_Z$ @ $I_{ZT}$ Volts (Note 1)	Test Current $I_{ZT}$ mA	Max Zener Impedance (Note 2)			Max Reverse Leakage Current		Maximum DC Zener Current $I_{ZM}$ mAdc	Device Marking
			$Z_{ZT}$ @ $I_{ZT}$ Ohms	$Z_{ZK}$ Ohms @	$I_{ZK}$ mA	$I_R$ @ $V_R$ $\mu\text{A}$ Volts			
<b>1SMB5929BT3</b>	<b>15</b>	<b>25</b>	<b>9</b>	<b>600</b>	<b>0.25</b>	<b>1</b>	<b>11.4</b>	<b>100</b>	<b>929B</b>
1SMB5930BT3	16	23.4	10	600	0.25	1	12.2	93	930B
<b>1SMB5931BT3</b>	<b>18</b>	<b>20.8</b>	<b>12</b>	<b>650</b>	<b>0.25</b>	<b>1</b>	<b>13.7</b>	<b>83</b>	<b>931B</b>
1SMB5932BT3	20	18.7	14	650	0.25	1	15.2	75	932B
1SMB5933BT3	22	17	17.5	650	0.25	1	16.7	68	933B
<b>1SMB5934BT3</b>	<b>24</b>	<b>15.6</b>	<b>19</b>	<b>700</b>	<b>0.25</b>	<b>1</b>	<b>18.2</b>	<b>62</b>	<b>934B</b>
<b>1SMB5935BT3</b>	<b>27</b>	<b>13.9</b>	<b>23</b>	<b>700</b>	<b>0.25</b>	<b>1</b>	<b>20.6</b>	<b>55</b>	<b>935B</b>
<b>1SMB5936BT3</b>	<b>30</b>	<b>12.5</b>	<b>26</b>	<b>750</b>	<b>0.25</b>	<b>1</b>	<b>22.8</b>	<b>50</b>	<b>936B</b>
1SMB5937BT3	33	11.4	33	800	0.25	1	25.1	45	937B
<b>1SMB5938BT3</b>	<b>36</b>	<b>10.4</b>	<b>38</b>	<b>850</b>	<b>0.25</b>	<b>1</b>	<b>27.4</b>	<b>41</b>	<b>938B</b>
1SMB5939BT3	39	9.6	45	900	0.25	1	29.7	38	939B
1SMB5940BT3	43	8.7	53	950	0.25	1	32.7	34	940B
1SMB5941BT3	47	8	67	1000	0.25	1	35.8	31	941B
1SMB5942BT3	51	7.3	70	1100	0.25	1	38.8	29	942B
1SMB5943BT3	56	6.7	86	1300	0.25	1	42.6	26	943B
1SMB5944BT3	62	6	100	1500	0.25	1	47.1	24	944B
1SMB5945BT3	68	5.5	120	1700	0.25	1	51.7	22	945B
1SMB5946BT3	75	5	140	2000	0.25	1	56	20	946B
1SMB5947BT3	82	4.6	160	2500	0.25	1	62.2	18	947B
1SMB5948BT3	91	4.1	200	3000	0.25	1	69.2	16	948B
<b>1SMB5949BT3</b>	<b>100</b>	<b>3.7</b>	<b>250</b>	<b>3100</b>	<b>0.25</b>	<b>1</b>	<b>76</b>	<b>15</b>	<b>949B</b>
1SMB5950BT3	110	3.4	300	4000	0.25	1	83.6	13	950B
1SMB5951BT3	120	3.1	380	4500	0.25	1	91.2	12	951B
1SMB5952BT3	130	2.9	450	5000	0.25	1	98.8	11	952B
1SMB5953BT3	150	2.5	600	6000	0.25	1	114	10	953B
1SMB5954BT3	160	2.3	700	6500	0.25	1	121.6	9	954B
1SMB5955BT3	180	2.1	900	7000	0.25	1	136.8	8	955B
1SMB5956BT3	200	1.9	1200	8000	0.25	1	152	7	956B

\*TOLERANCE AND VOLTAGE DESIGNATION Tolerance designation — The type numbers listed indicate a tolerance of  $\pm 5\%$ .

Devices listed in bold, italic are Motorola preferred devices.

# 1SMB5913BT3 Series

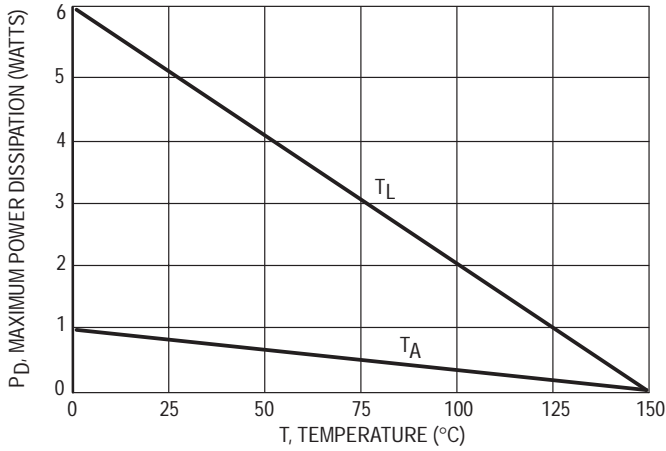


Figure 1. Steady State Power Derating

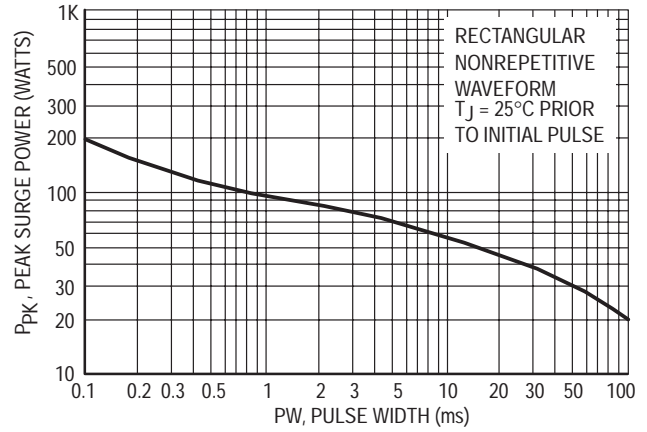


Figure 2. Maximum Surge Power

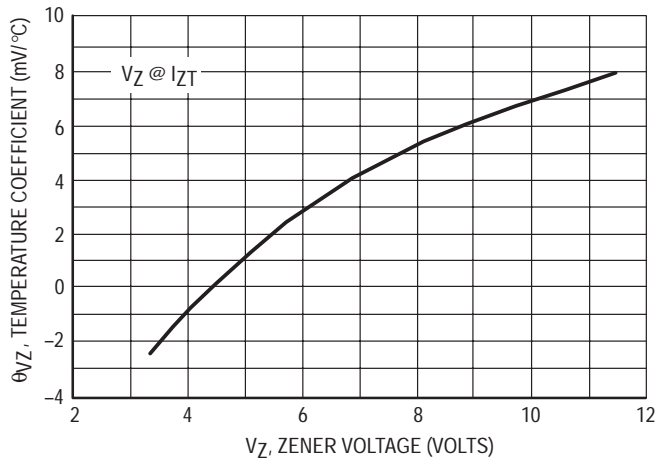


Figure 3. Zener Voltage — To 12 Volts

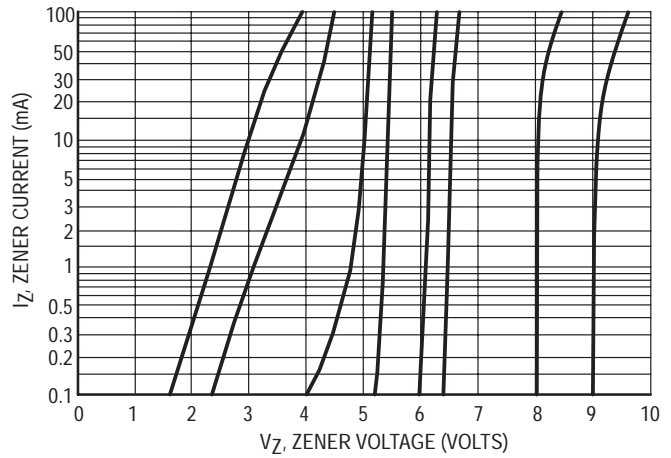


Figure 4. V<sub>Z</sub> = 3.3 thru 10 Volts

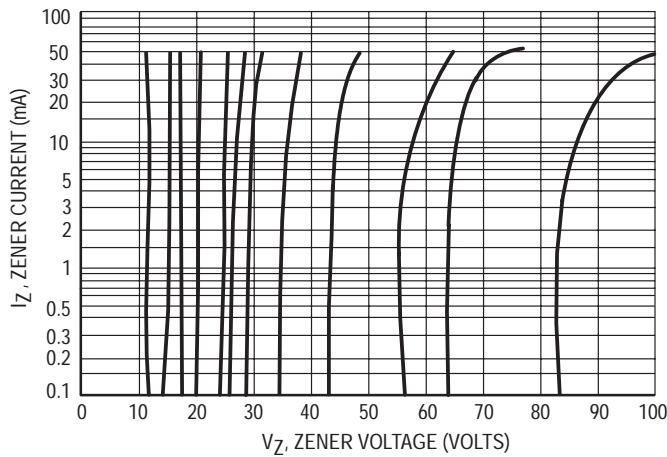


Figure 5. V<sub>Z</sub> = 12 thru 82 Volts

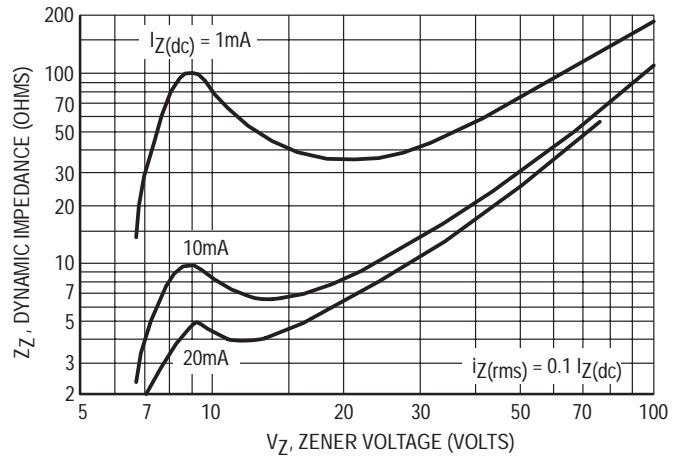


Figure 6. Effect of Zener Voltage

# 1SMB5913BT3 Series

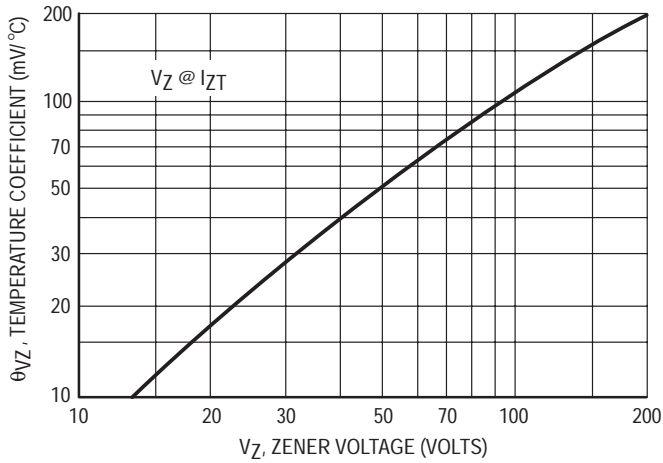


Figure 7. Zener Voltage — 14 To 200 Volts

**NOTE 1. ZENER VOLTAGE ( $V_Z$ ) MEASUREMENT**

Nominal zener voltage is measured with the device junction in thermal equilibrium with ambient temperature at 25°C.

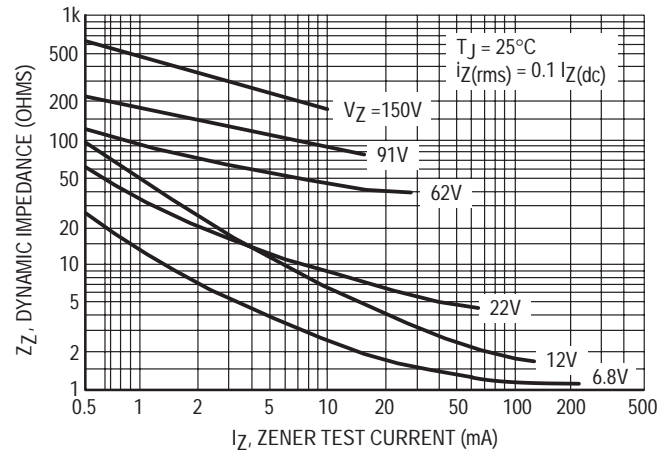


Figure 8. Effect of Zener Current

**NOTE 2. ZENER IMPEDANCE ( $Z_Z$ ) DERIVATION**

$Z_{ZT}$  and  $Z_{ZK}$  are measured by dividing the ac voltage drop across the device by the ac current applied. The specified limits are for  $I_Z(ac) = 0.1 I_Z(dc)$  with the ac frequency = 60 Hz.

# Zener Voltage Regulator Diodes — Surface Mounted

## 3 Watt DC Power

NOTES:

1. DIMENSIONING AND TOLERANCING PER ANSI Y14.5M, 1982.
2. CONTROLLING DIMENSION: INCH.
3. D DIMENSION SHALL BE MEASURED WITHIN DIMENSION P.

DIM	INCHES		MILLIMETERS	
	MIN	MAX	MIN	MAX
A	0.160	0.180	4.06	4.57
B	0.130	0.150	3.30	3.81
C	0.075	0.095	1.90	2.41
D	0.077	0.083	1.96	2.11
H	0.0020	0.0060	0.051	0.152
J	0.006	0.012	0.15	0.30
K	0.030	0.050	0.76	1.27
P	0.020 REF		0.51 REF	
S	0.205	0.220	5.21	5.59

**SMB Footprint**

(inches / mm)

**CASE 403A-03 PLASTIC**

(Refer to Section 10 for Surface Mount, Thermal Data and Footprint Information.)

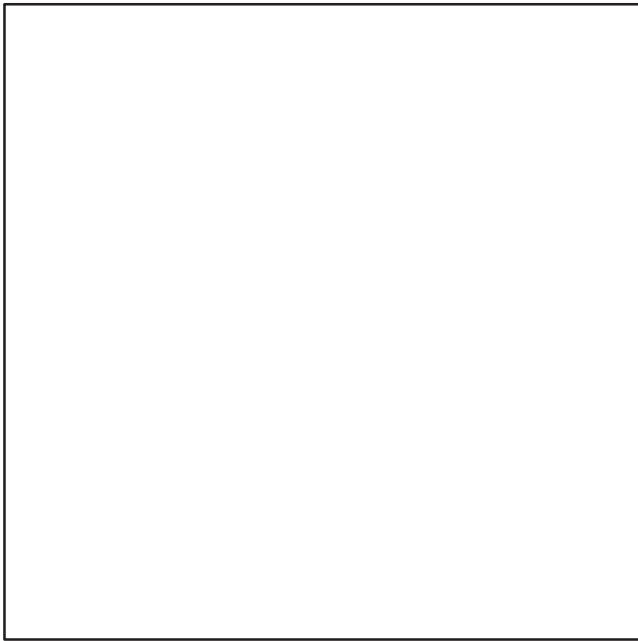
### MULTIPLE PACKAGE QUANTITY (MPQ) REQUIREMENTS

Package Option	Type No. Suffix	MPQ (Units)
Tape and Reel	T3 (13 inch)	2.5K

(Refer to Section 10 for more information on Packaging Specifications.)



# Section Eight



## Zener Voltage Reference Diodes Data Sheets

### 6.2 Volt OTC 400 mW DO-35

1N821,A 1N823,A 1N825,A

1N827,A 1N829,A ..... 8-2

# Temperature-Compensated Zener Reference Diodes

Temperature-compensated zener reference diodes utilizing a single chip oxide passivated junction for long-term voltage stability. A rugged, glass-enclosed, hermetically sealed structure.

**Mechanical Characteristics:**

**CASE:** Hermetically sealed, all-glass

**DIMENSIONS:** See outline drawing.

**FINISH:** All external surfaces are corrosion resistant and leads are readily solderable.

**POLARITY:** Cathode indicated by polarity band.

**WEIGHT:** 0.2 Gram (approx.)

**MOUNTING POSITION:** Any

**Maximum Ratings**

Junction Temperature: - 55 to +175°C

Storage Temperature: - 65 to +175°C

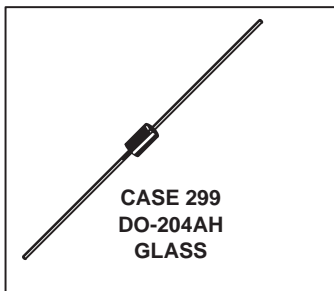
DC Power Dissipation: 400 mW @ T<sub>A</sub> = 50°C

**WAFER FAB LOCATION:** Phoenix, Arizona

**ASSEMBLY/TEST LOCATION:** Phoenix, Arizona

**1N821,A 1N823,A**  
**1N825,A 1N827,A**  
**1N829,A**

**TEMPERATURE-  
 COMPENSATED  
 SILICON ZENER  
 REFERENCE DIODES**  
**6.2 V, 400 mW**



**ELECTRICAL CHARACTERISTICS** (T<sub>A</sub> = 25°C unless otherwise noted. V<sub>Z</sub> = 6.2 V ± 5%\* @ I<sub>ZT</sub> = 7.5 mA) (Note 5)

JEDEC Type No.	Maximum Voltage Change ΔV <sub>Z</sub> (Volts) (Note 1)	Ambient Test Temperature °C ±1°C	Temperature Coefficient For Reference Only %/°C (Note 1)	Maximum Dynamic Impedance Z <sub>ZT</sub> Ohms (Note 2)
<b>1N821</b>	<b>0.096</b>	- 55, 0, +25, +75, +100	<b>0.01</b>	<b>15</b>
<b>1N823</b>	<b>0.048</b>		<b>0.005</b>	
<b>1N825</b>	<b>0.019</b>		<b>0.002</b>	
1N827	0.009		0.001	
1N829	0.005		0.0005	
<b>1N821A</b>	<b>0.096</b>		<b>0.01</b>	<b>10</b>
<b>1N823A</b>	<b>0.048</b>		<b>0.005</b>	
<b>1N825A</b>	<b>0.019</b>		<b>0.002</b>	
1N827A	0.009		0.001	
1N829A	0.005		0.0005	

\*Tighter-tolerance units available on special request.

Devices listed in bold, italic are Motorola preferred devices.

# 1N821,A 1N823,A 1N825,A 1N827,A 1N829,A

## MAXIMUM VOLTAGE CHANGE versus AMBIENT TEMPERATURE

(with  $I_{ZT} = 7.5 \text{ mA} \pm 0.01 \text{ mA}$ ) (See Note 3)

1N821 through 1N829

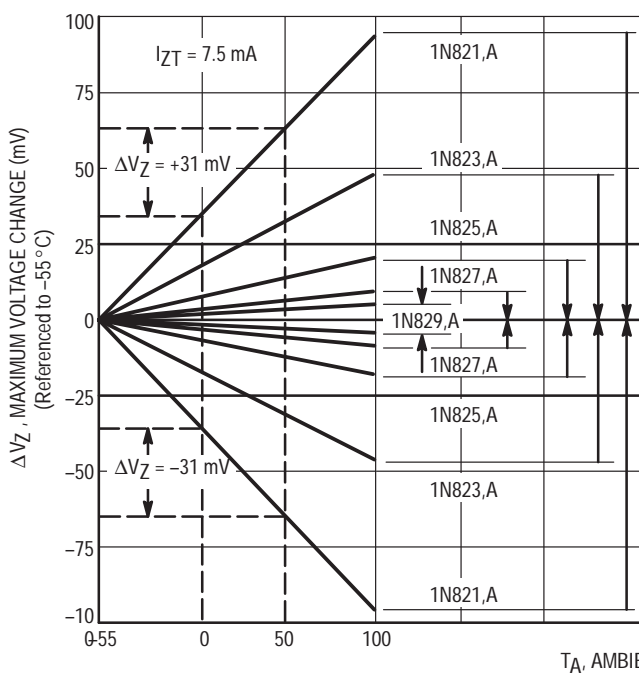


Figure 1a

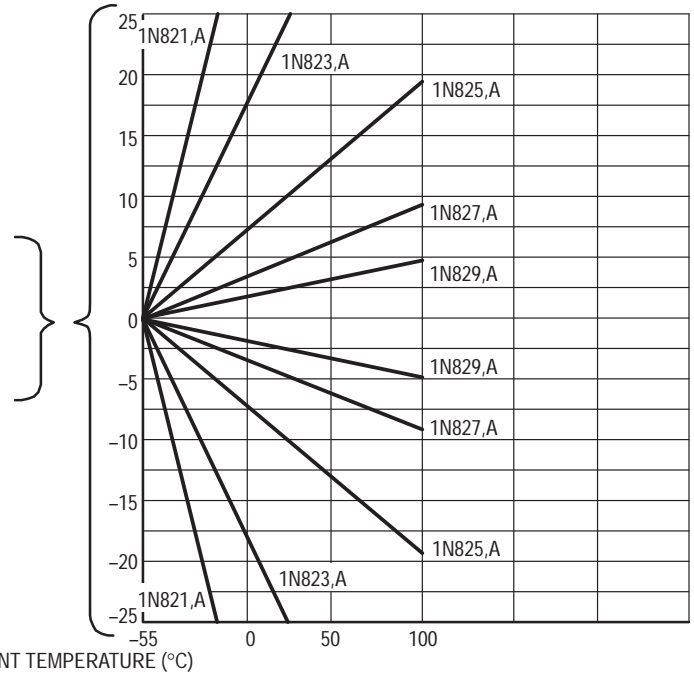


Figure 1b

## ZENER CURRENT versus MAXIMUM VOLTAGE CHANGE

(At Specified Temperatures)

(See Note 4)

MORE THAN 95% OF THE UNITS ARE IN THE RANGES INDICATED BY THE CURVES.

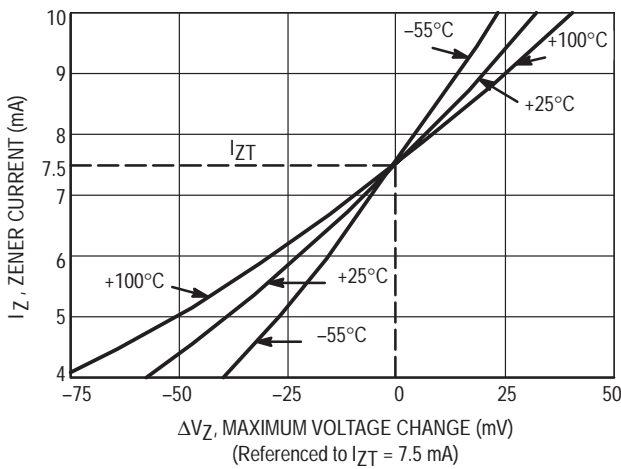


Figure 2. 1N821 Series

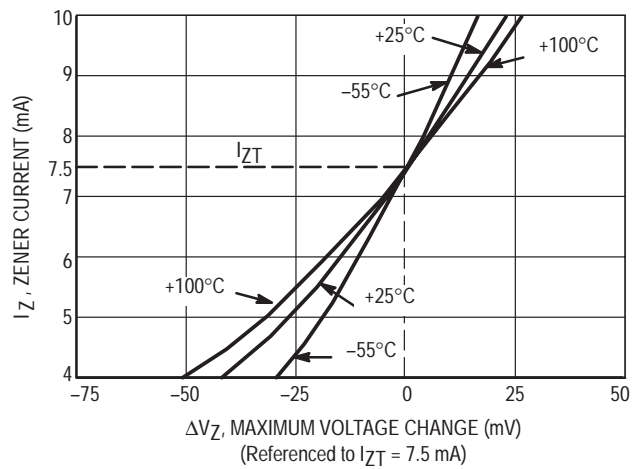


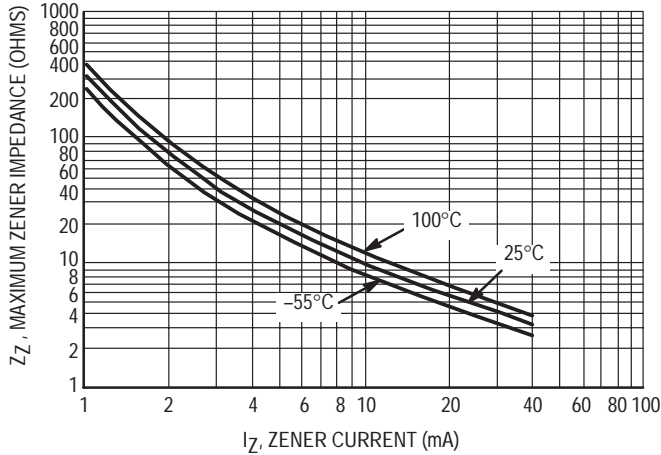
Figure 3. 1N821A Series



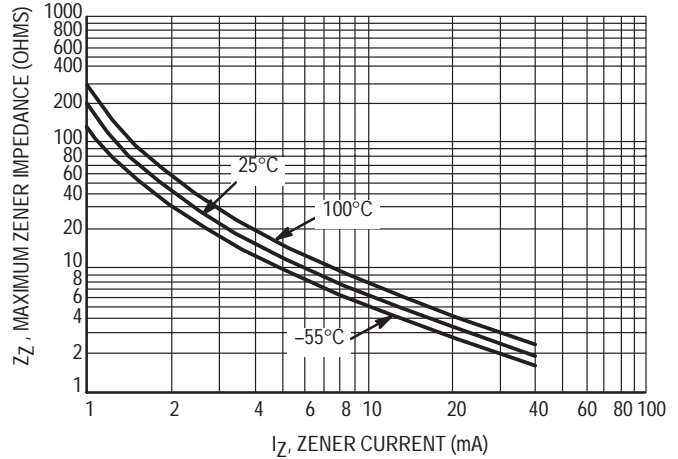
**MAXIMUM ZENER IMPEDANCE versus ZENER CURRENT**

(See Note 2)

MORE THAN 95% OF THE UNITS ARE IN THE RANGES INDICATED BY THE CURVES.



**Figure 4. 1N821 Series**



**Figure 5. 1N821A Series**

**NOTE 1. VOLTAGE VARIATION ( $\Delta V_Z$ ) AND TEMPERATURE COEFFICIENT**

All reference diodes are characterized by the "box method." This guarantees a maximum voltage variation ( $\Delta V_Z$ ) over the specified temperature range, at the specified test current ( $I_{ZT}$ ), verified by tests at indicated temperature points within the range.  $V_Z$  is measured and recorded at each temperature specified. The  $\Delta V_Z$  between the highest and lowest values must not exceed the maximum  $\Delta V_Z$  given. This method of indicating voltage stability is now used for JEDEC registration as well as for military qualification. The former method of indicating voltage stability — by means of temperature coefficient accurately reflects the voltage deviation at the temperature extremes, but is not necessarily accurate within the temperature range because reference diodes have a nonlinear temperature relationship. The temperature coefficient, therefore, is given only as a reference.

**NOTE 2.**

The dynamic zener impedance,  $Z_{ZT}$ , is derived from the 60 Hz ac voltage drop which results when an ac current with an rms value equal to 10% of the dc zener current,  $I_{ZT}$ , is superimposed on  $I_{ZT}$ . Curves showing the variation of zener impedance with zener current for each series are given in Figures 4 and 5.

**NOTE 3.**

These graphs can be used to determine the maximum voltage change of any device in the series over any specific temperature range. For example, a temperature change from 0 to +50°C will cause a voltage change no greater than +31 mV or - 31 mV for 1N821 or 1N821A, as illustrated by the dashed lines in Figure 1. The boundaries given are maximum values. For greater resolution, an expanded view of the center area in Figure 1a is shown in Figure 1b.

**NOTE 4.**

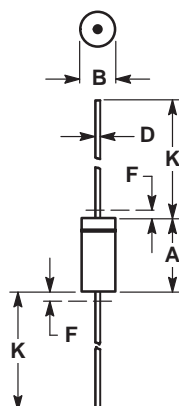
The maximum voltage change,  $\Delta V_Z$ , Figures 2 and 3 is due entirely to the impedance of the device. If both temperature and  $I_{ZT}$  are varied, then the total voltage change may be obtained by graphically adding  $\Delta V_Z$  in Figure 2 or 3 to the  $\Delta V_Z$  in Figure 1 for the device under consideration. If the device is to be operated at some stable current other than the specified test current, a new set of characteristics may be plotted by superimposing the data in Figure 2 or 3 on Figure 1. For a more detailed explanation see application note in later section.

**NOTE 5.**

Zener voltage limits at 25°C measured with the test current ( $I_{ZT}$ ) applied with the device junction in thermal equilibrium at an ambient temperature of 25°C.

# Zener Voltage Reference Diodes

## 6.2 Volt OTC 400 mW DO-35



- NOTES:
1. PACKAGE CONTOUR OPTIONAL WITHIN A AND B HEAT SLUGS, IF ANY, SHALL BE INCLUDED WITHIN THIS CYLINDER, BUT NOT SUBJECT TO THE MINIMUM LIMIT OF B.
  2. LEAD DIAMETER NOT CONTROLLED IN ZONE F TO ALLOW FOR FLASH, LEAD FINISH BUILDUP AND MINOR IRREGULARITIES OTHER THAN HEAT SLUGS.
  3. POLARITY DENOTED BY CATHODE BAND.
  4. DIMENSIONING AND TOLERANCING PER ANSI Y14.5M, 1982.

DIM	MILLIMETERS		INCHES	
	MIN	MAX	MIN	MAX
A	3.05	5.08	0.120	0.200
B	1.52	2.29	0.060	0.090
D	0.46	0.56	0.018	0.022
F	—	1.27	—	0.050
K	25.40	38.10	1.000	1.500

All JEDEC dimensions and notes apply.

**CASE 299-02  
DO-204AH  
GLASS**

(Refer to Section 10 for Surface Mount, Thermal Data and Footprint Information.)

### MULTIPLE PACKAGE QUANTITY (MPQ) REQUIREMENTS

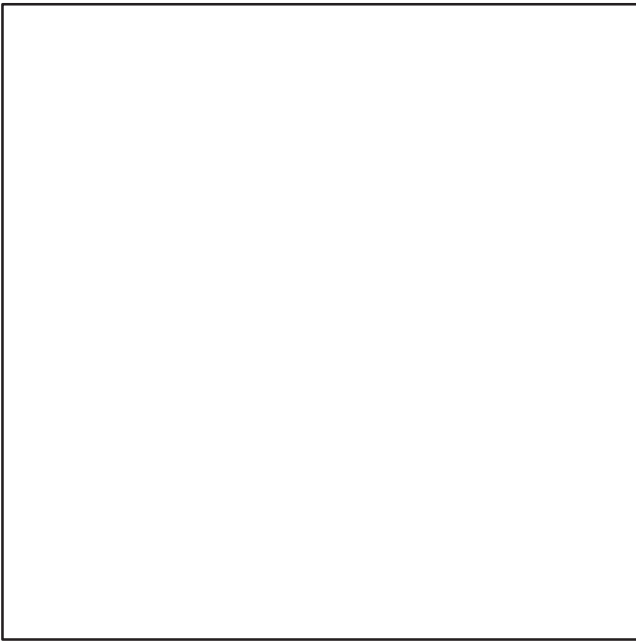
Package Option	Type No. Suffix	MPQ (Units)
Tape and Reel	RL, RL2 <sup>(1)</sup>	5K
Tape and Ammo	TA, TA2 <sup>(1)</sup>	5K

NOTE: 1. The "2" suffix designates 26 mm tape spacing.

(Refer to Section 10 for more information on Packaging Specifications.)



# Section Nine



## Current Regulator Diodes — Axial Leaded Data Sheets

### 1.5 Watt DC Power

General Data .....	9-2
1N5283 through 1N5314 .....	9-2

## Current Regulator Diodes

Field-effect current regulator diodes are circuit elements that provide a current essentially independent of voltage. These diodes are especially designed for maximum impedance over the operating range. These devices may be used in parallel to obtain higher currents.

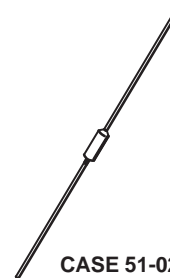
**Manufacturing Locations:**

**WAFER FAB:** Phoenix, Arizona

**ASSEMBLY/TEST:** Phoenix, Arizona

**1N5283**  
**through**  
**1N5314**

**CURRENT**  
**REGULATOR**  
**DIODES**



**MAXIMUM RATINGS**

Rating	Symbol	Value	Unit
Peak Operating Voltage ( $T_J = -55^{\circ}\text{C}$ to $+200^{\circ}\text{C}$ )	POV	100	Volts
Steady State Power Dissipation @ $T_L = 75^{\circ}\text{C}$ Derate above $T_L = 75^{\circ}\text{C}$ Lead Length = 3/8" (Forward or Reverse Bias)	$P_D$	600 4.8	mW mW/ $^{\circ}\text{C}$
Operating and Storage Junction Temperature Range	$T_J, T_{stg}$	-55 to +200	$^{\circ}\text{C}$

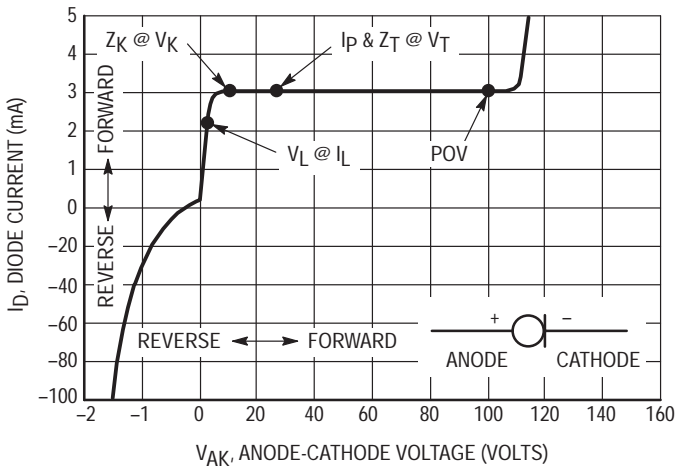
# 1N5283 through 1N5314

## ELECTRICAL CHARACTERISTICS ( $T_A = 25^\circ\text{C}$ unless otherwise noted)

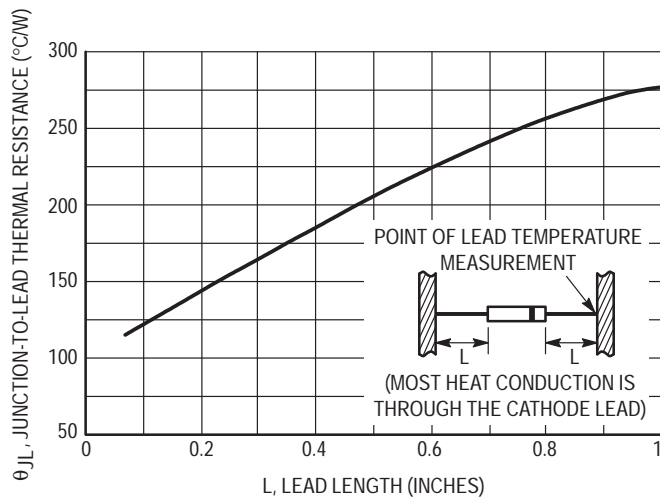
Type No.	Regulator Current $I_P$ (mA) @ $V_T = 25$ V			Minimum Dynamic Impedance @ $V_T = 25$ V $Z_T$ (M $\Omega$ )	Minimum Knee Impedance @ $V_K = 6.0$ V $Z_K$ (M $\Omega$ )	Maximum Limiting Voltage @ $I_L = 0.8 I_P$ (min) $V_L$ (Volts)
	Nom	Min	Max			
<b>1N5283</b>	0.22	0.198	0.242	25.0	2.75	1.00
1N5284	0.24	0.216	0.264	19.0	2.35	1.00
1N5285	0.27	0.243	0.297	14.0	1.95	1.00
1N5286	0.30	0.270	0.330	9.00	1.60	1.00
<b>1N5287</b>	0.33	0.297	0.363	6.60	1.35	1.00
1N5288	0.39	0.351	0.429	4.10	1.00	1.05
1N5289	0.43	0.387	0.473	3.30	0.870	1.05
<b>1N5290</b>	0.47	0.423	0.517	2.70	0.750	1.05
<b>1N5291</b>	0.56	0.504	0.616	1.90	0.560	1.10
1N5292	0.62	0.558	0.682	1.55	0.470	1.13
1N5293	0.68	0.612	0.748	1.35	0.400	1.15
1N5294	0.75	0.675	0.825	1.15	0.335	1.20
1N5295	0.82	0.738	0.902	1.00	0.290	1.25
1N5296	0.91	0.819	1.001	0.880	0.240	1.29
<b>1N5297</b>	1.00	0.900	1.100	0.800	0.205	1.35
<b>1N5298</b>	1.10	0.990	1.21	0.700	0.180	1.40
<b>1N5299</b>	1.20	1.08	1.32	0.640	0.155	1.45
1N5300	1.30	1.17	1.43	0.580	0.135	1.50
1N5301	1.40	1.26	1.54	0.540	0.115	1.55
<b>1N5302</b>	1.50	1.35	1.65	0.510	0.105	1.60
1N5303	1.60	1.44	1.76	0.475	0.092	1.65
1N5304	1.80	1.62	1.98	0.420	0.074	1.75
<b>1N5305</b>	2.00	1.80	2.20	0.395	0.061	1.85
<b>1N5306</b>	2.20	1.98	2.42	0.370	0.052	1.95
<b>1N5307</b>	2.40	2.16	2.64	0.345	0.044	2.00
1N5308	2.70	2.43	2.97	0.320	0.035	2.15
<b>1N5309</b>	3.00	2.70	3.30	0.300	0.029	2.25
1N5310	3.30	2.97	3.63	0.280	0.024	2.35
1N5311	3.60	3.24	3.96	0.265	0.020	2.50
<b>1N5312</b>	3.90	3.51	4.29	0.255	0.017	2.60
<b>1N5313</b>	4.30	3.87	4.73	0.245	0.014	2.75
<b>1N5314</b>	4.70	4.23	5.17	0.235	0.012	2.90

Devices listed in bold, italic are Motorola preferred devices.

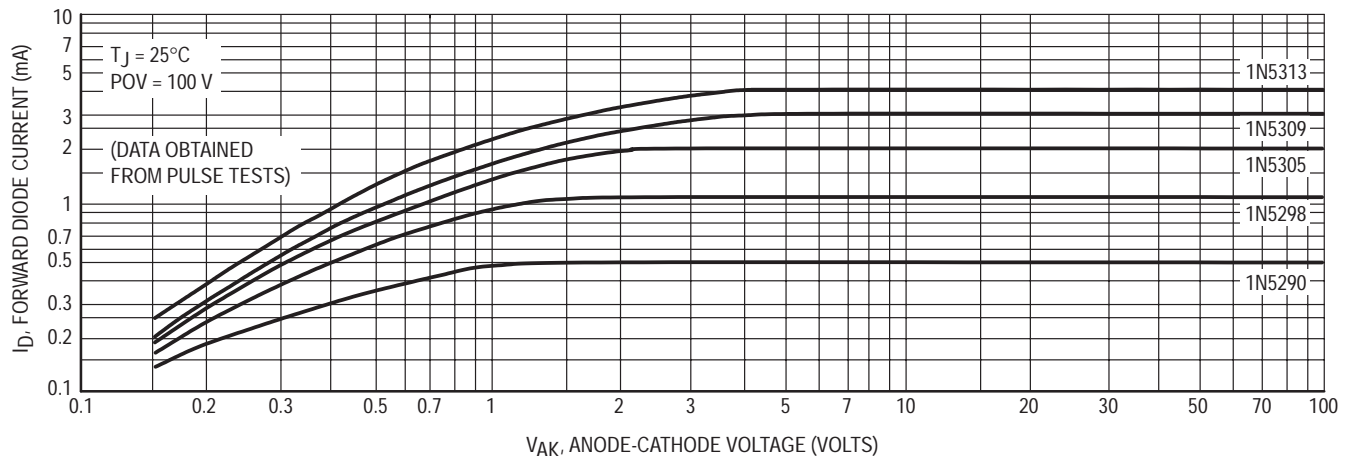
# 1N5283 through 1N5314



**Figure 1. Typical Current Regulator Characteristics**



**Figure 2. Typical Thermal Resistance**



**Figure 3. Typical Forward Characteristics**

## SYMBOLS AND DEFINITIONS

- $I_D$  — Diode Current.
- $I_L$  — Limiting Current: 80% of  $I_p$  minimum used to determine Limiting voltage,  $V_L$ .
- $I_p$  — Pinch-off Current: Regulator current at specified Test Voltage,  $V_T$ .
- POV — Peak Operating Voltage: Maximum voltage to be applied to device.
- $\theta_I$  — Current Temperature Coefficient.
- $V_{AK}$  — Anode-to-cathode Voltage.
- $V_K$  — Knee Impedance Test Voltage: Specified voltage used to establish Knee Impedance,  $Z_K$ .
- $V_L$  — Limiting Voltage: Measured at  $I_L$ ,  $V_L$ , together with Knee AC Impedance,  $Z_K$ , indicates the Knee characteristics of the device.
- $V_T$  — Test Voltage: Voltage at which  $I_p$  and  $Z_T$  are specified.
- $Z_K$  — Knee AC Impedance at Test Voltage: To test for  $Z_K$ , a 90 Hz signal  $V_K$  with RMS value equal to 10% of test voltage,  $V_K$ , is superimposed on  $V_K$ :  

$$Z_K = V_K / i_K$$
 where  $i_K$  is the resultant ac current due to  $V_K$ .  
 To provide the most constant current from the diode,  $Z_K$  should be as high as possible; therefore, a minimum value of  $Z_K$  is specified.
- $Z_T$  — AC Impedance at Test Voltage: Specified as a minimum value. To test for  $Z_T$ , a 90 Hz signal with RMS value equal to 10% of Test Voltage  $V_T$ , is superimposed on  $V_T$ .

## APPLICATION NOTE

As the current available from the diode is temperature dependent, it is necessary to determine junction temperature,  $T_J$ , under specific operating conditions to calculate the value of the diode current. The following procedure is recommended:

Lead Temperature,  $T_L$ , shall be determined from:

$$T_L = \theta_{LA} P_D + T_A$$

where  $\theta_{LA}$  is lead-to-ambient thermal resistance and  $P_D$  is power dissipation.

$\theta_{LA}$  is generally 30–40°C/W for the various clips and tie points in common use, and for printed circuit-board wiring.

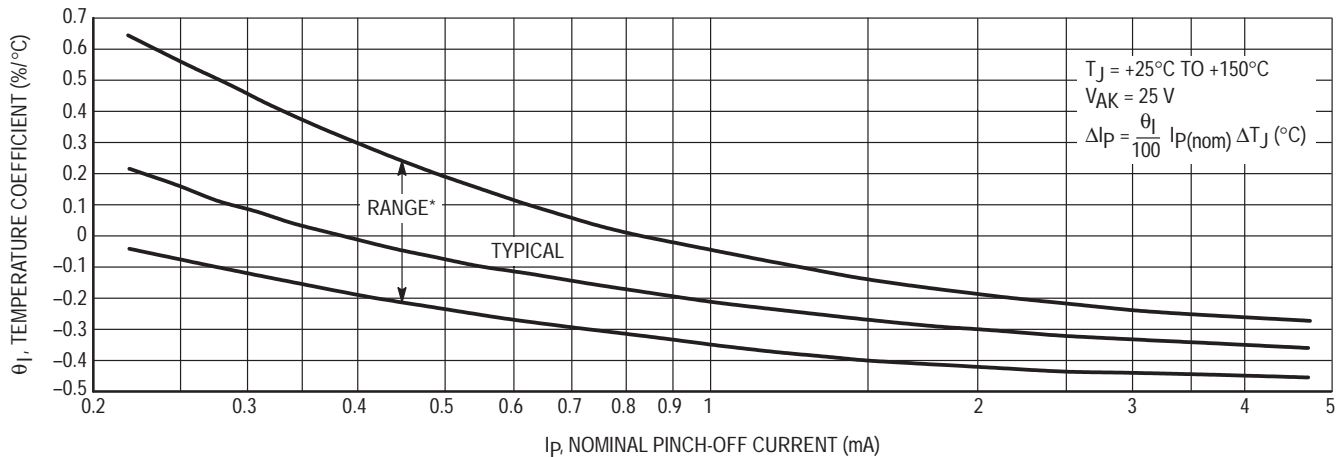
Junction Temperature,  $T_J$ , shall be calculated from:

$$T_J = T_L + \theta_{JL} P_D$$

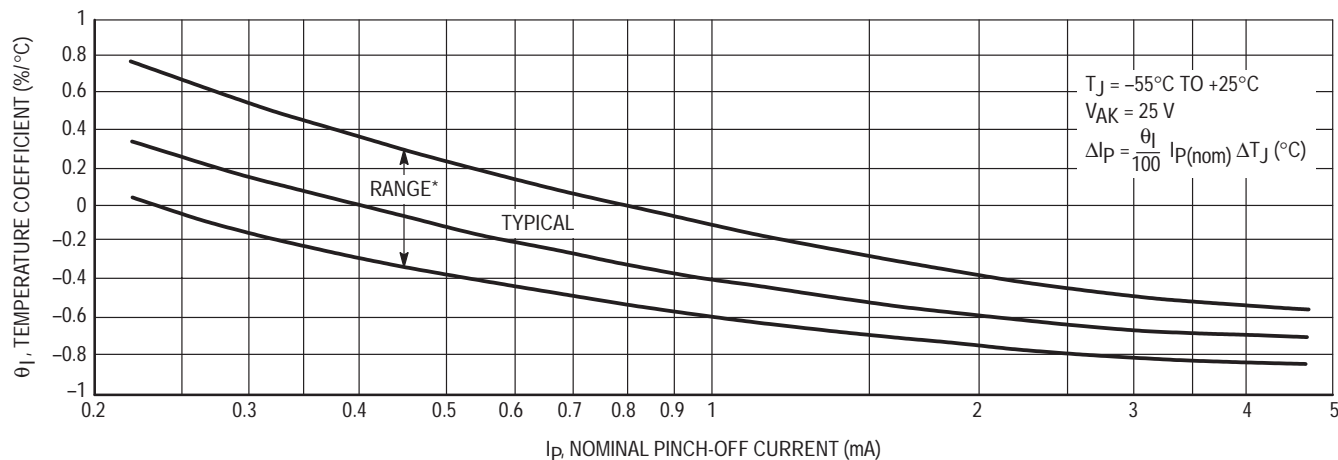
where  $\theta_{JL}$  is taken from Figure 2.

For circuit design limits of  $V_{AK}$ , limits of  $P_D$  may be estimated and extremes of  $T_J$  may be computed. Using the information on Figures 4 and 5, changes in current may be found. To improve current regulation, keep  $V_{AK}$  low to reduce  $P_D$  and keep the leads short, especially the cathode lead, to reduce  $\theta_{JL}$ .

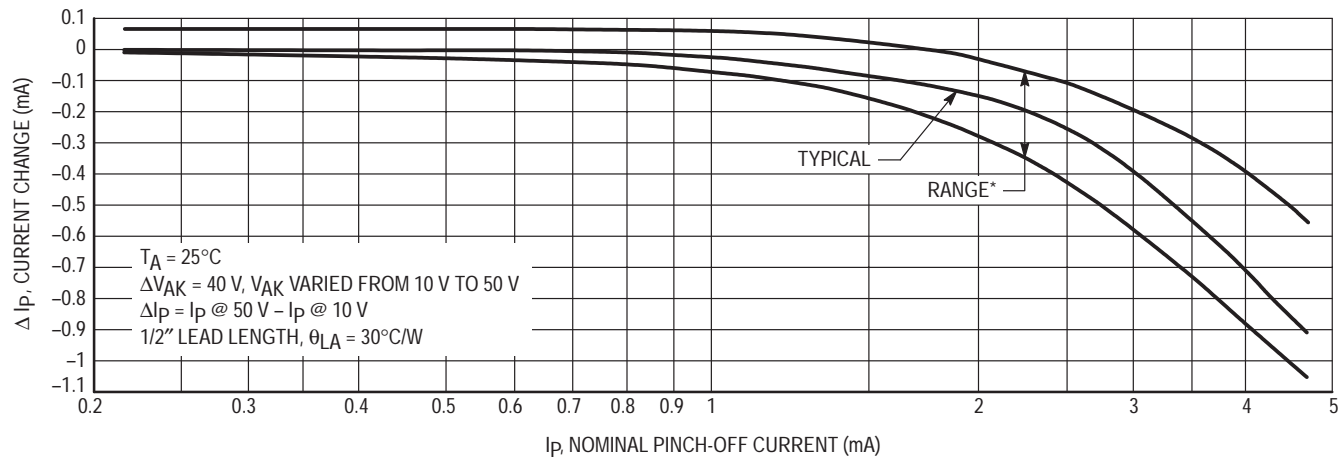
# 1N5283 through 1N5314



**Figure 4. Temperature Coefficient**



**Figure 5. Temperature Coefficient**



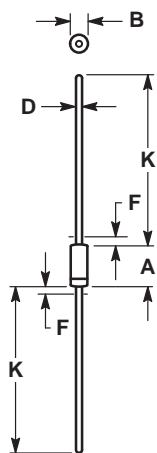
\*90% of the units will be in the ranges shown.

**Figure 6. Current Regulation Factor**



# Current Regulator Diodes — Axial Leaded

## 1.5 Watt DC Power



- NOTES:
1. PACKAGE CONTOUR OPTIONAL WITHIN DIA B AND LENGTH A. HEAT SLUGS, IF ANY, SHALL BE INCLUDED WITHIN THIS CYLINDER, BUT SHALL NOT BE SUBJECT TO THE MIN LIMIT OF DIA B.
  2. LEAD DIA NOT CONTROLLED IN ZONES F, TO ALLOW FOR FLASH, LEAD FINISH BUILDUP, AND MINOR IRREGULARITIES OTHER THAN HEAT SLUGS.

DIM	MILLIMETERS		INCHES	
	MIN	MAX	MIN	MAX
A	5.84	7.62	0.230	0.300
B	2.16	2.72	0.085	0.107
D	0.46	0.56	0.018	0.022
F	—	1.27	—	0.050
K	25.40	38.10	1.000	1.500

All JEDEC dimensions and notes apply

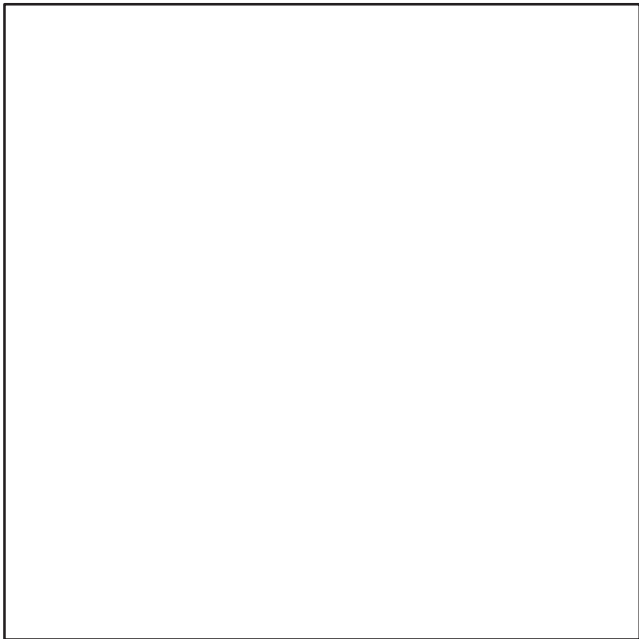
**CASE 51-02  
DO-204AA  
GLASS**

(Refer to Section 10 for Surface Mount, Thermal Data and Footprint Information.)

### MULTIPLE PACKAGE QUANTITY (MPQ) REQUIREMENTS

Package Option	Type No. Suffix	MPQ (Units)
Tape and Reel	RL	2.5K
Bulk	(None)	500

(Refer to Section 10 for more information on Packaging Specifications.)



# Section Ten

## Surface Mount Information and Packaging Specifications

<b>TVS/Zener Axial Lead</b> .....	10-2
Lead Tape Packaging Standards for Axial-Lead Components .....	10-2
<b>TVS/Zener Surface Mount</b> .....	10-4
Embossed Tape and Reel .....	10-4

# TVS/Zener Axial-Lead Lead Tape Packaging Standards for Axial-Lead Components

## 1.0 SCOPE

This section covers packaging requirements for the following axial-lead component's use in automatic testing and assembly equipment: Motorola Case 17-02, Case 41A-02, Case 51-02 (DO-7), Case 59-03 (DO-41), Case 59-04, Case 194-04 and Case 299-02 (DO-35). Packaging, as covered in this section, shall consist of axial-lead components mounted by their leads on pressure sensitive tape, wound onto a reel.

## 2.0 PURPOSE

This section establishes Motorola standard practices for lead-tape packaging of axial-lead components and meets the requirements of EIA Standard RS-296-D "Lead-taping of Components on Axial Lead Configuration for Automatic Insertion," level 1.

## 3.0 REQUIREMENTS

### 3.1 Component leads

**3.1.1** – Component leads shall not be bent beyond dimension E from their normal position. See Figure 2.

**3.1.2** – The "C" dimension shall be governed by the overall length of the reel packaged component. The distance between flanges shall be 0.059 inch to 0.315 inch greater than the overall component length. See Figures 2 and 3.

**3.1.3** – Cumulative dimension "A" tolerance shall not exceed 0.059 over 6 in consecutive components.

### 3.2 Orientation

All polarized components must be oriented in one direction. The cathode lead tape shall be blue and the anode tape shall be white. See Figure 1.

### 3.3 Reeling

**3.3.1** – Components on any reel shall not represent more than two date codes when date code identification is required.

**3.3.2** – Component's leads shall be positioned perpendicularly between pairs of 0.250 inch tape. See Figure 2.

**3.3.3** – A minimum 12 inch leader of tape shall be provided before the first and last component on the reel.

**3.3.4** – 50 lb. Kraft paper is wound between layers of components as far as necessary for component protection.

**3.3.5** – Components shall be centered between tapes such that the difference between D1 and D2 does not exceed 0.055.

**3.3.6** – Staples shall not be used for splicing. No more than four layers of tape shall be used in any splice area and no tape shall be offset from another by more than 0.031 inch noncumulative. Tape splices shall overlap at least 6 inches for butt joints and at least 3 inches for lap joints and shall not be weaker than unspliced tape.

**3.3.7** – Quantity per reel shall be as indicated in Table 1. Orders for tape and reeled product will only be processed and shipped in full reel increments. Scheduled orders must be in releases of full reel increments or multiples thereof.

**3.3.8** – A maximum of 0.25% of the components per reel quantity may be missing without consecutive missing per level 1 of RS-296-D.

**3.3.9** – The single face roll pad shall be placed around the finished reel and taped securely. Each reel shall then be placed in an appropriate container.

## 3.4 Marking

Minimum reel and carton marking shall consist of the following (see Figure 3):

Motorola part number

Quantity

Manufacturer's name

Date codes (when applicable; see note **3.3.1**)

## 4.0

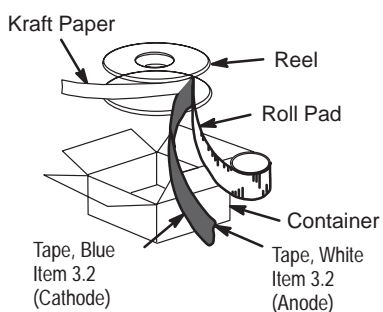
Requirements differing from this Motorola standard shall be negotiated with the factory.

The packages indicated in the following table are suitable for lead tape packaging. The table indicates the specific devices (transient voltage suppressors and/or zeners) that can be obtained from Motorola in reel packaging and provides the appropriate packaging specification.

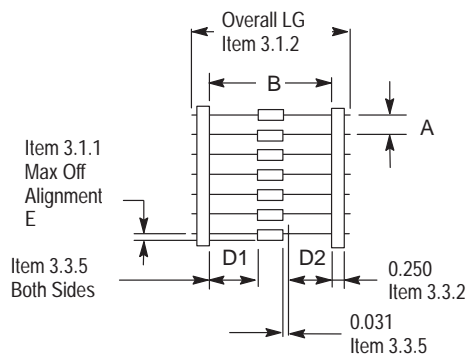
## Lead Tape Packaging Standards for Axial-Lead Components (continued)

**Table 1. Packaging Details (all dimensions in inches)**

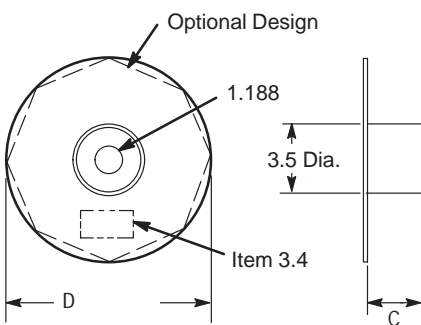
Case Type	Product Category	Device Title Suffix	MPQ Quantity Per Reel (Item 3.3.7)	Component Spacing A Dimension	Tape Spacing B Dimension	Reel Dimension C	Reel Dimension D (Max)	Max Off Alignment E
Case 17	Surmetic 40 & 600 Watt TVS	RL	4000	0.2 +/- 0.015	2.062 +/- 0.059	3	14	0.047
Case 41A	1500 Watt TVS	RL4	1500	0.4 +/- 0.02	2.062 +/- 0.059	3	14	0.047
Case 51-02	DO-7 Glass (For Reference only)	RL	3000	0.2 +/- 0.02	2.062 +/- 0.059	3	14	0.047
Case 59-03	DO-41 Glass & DO-41 Surmetic 30	RL	6000	0.2 +/- 0.015	2.062 +/- 0.059	3	14	0.047
	Rectifier							
Case 59-04	500 Watt TVS	RL	5000	0.2 +/- 0.02	2.062 +/- 0.059	3	14	0.047
	Rectifier							
Case 194-04	110 Amp TVS (Automotive)	RL	800	0.4 +/- 0.02	1.875 +/- 0.059	3	14	0.047
	Rectifier							
Case 267-02	Rectifier	RL	1500	0.4 +/- 0.02	2.062 +/- 0.059	3	14	0.047
Case 299	DO-35 Glass	RL	5000	0.2 +/- 0.02	2.062 +/- 0.059	3	14	0.047



**Figure 1. Reel Packing**



**Figure 2. Component Spacing**



**Figure 3. Reel Dimensions**

# TVS/Zener Surface Mount Embossed Tape and Reel

Embossed Tape and Reel is used to facilitate automatic pick and place equipment feed requirements. The tape is used as the shipping container for various products and requires a minimum of handling. The antistatic/conductive tape provides a secure cavity for the product when sealed with the "peel-back" cover tape.

- Used for Automatic Pick and Place Feed Systems
- Minimizes Product Handling
- EIA 481-1, 8 mm and 12 mm Taping of Surface Mount Components for Automatic Handling and EIA 481-2, 16 mm and 24 mm Embossed Carrier Taping of Surface Mount Components for Automatic Handling
- SOD-123, SOT-23 in 8 mm Tape
- SMB in 12 mm Tape
- SMC in 16 mm Tape

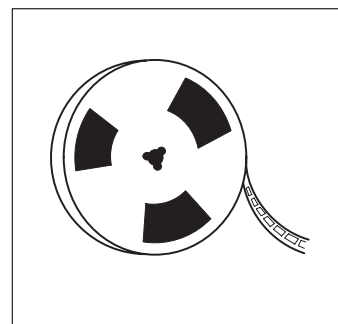
## Ordering Information

Use the standard device title and add the required suffix as listed in the option table below. Note that the individual reels have a finite number of devices depending on the type of product contained in the tape. Also note the minimum lot size is one full reel for each line item and orders are required to be in increments of the single reel quantity.

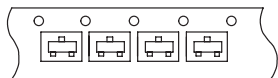
## Tape and Reel Data for TVS/Zener Surface Mount Devices

### PACKAGES

SOD-123 SOT-23  
SMB SMC



SOT-23  
8 mm



SOD-123  
8 mm



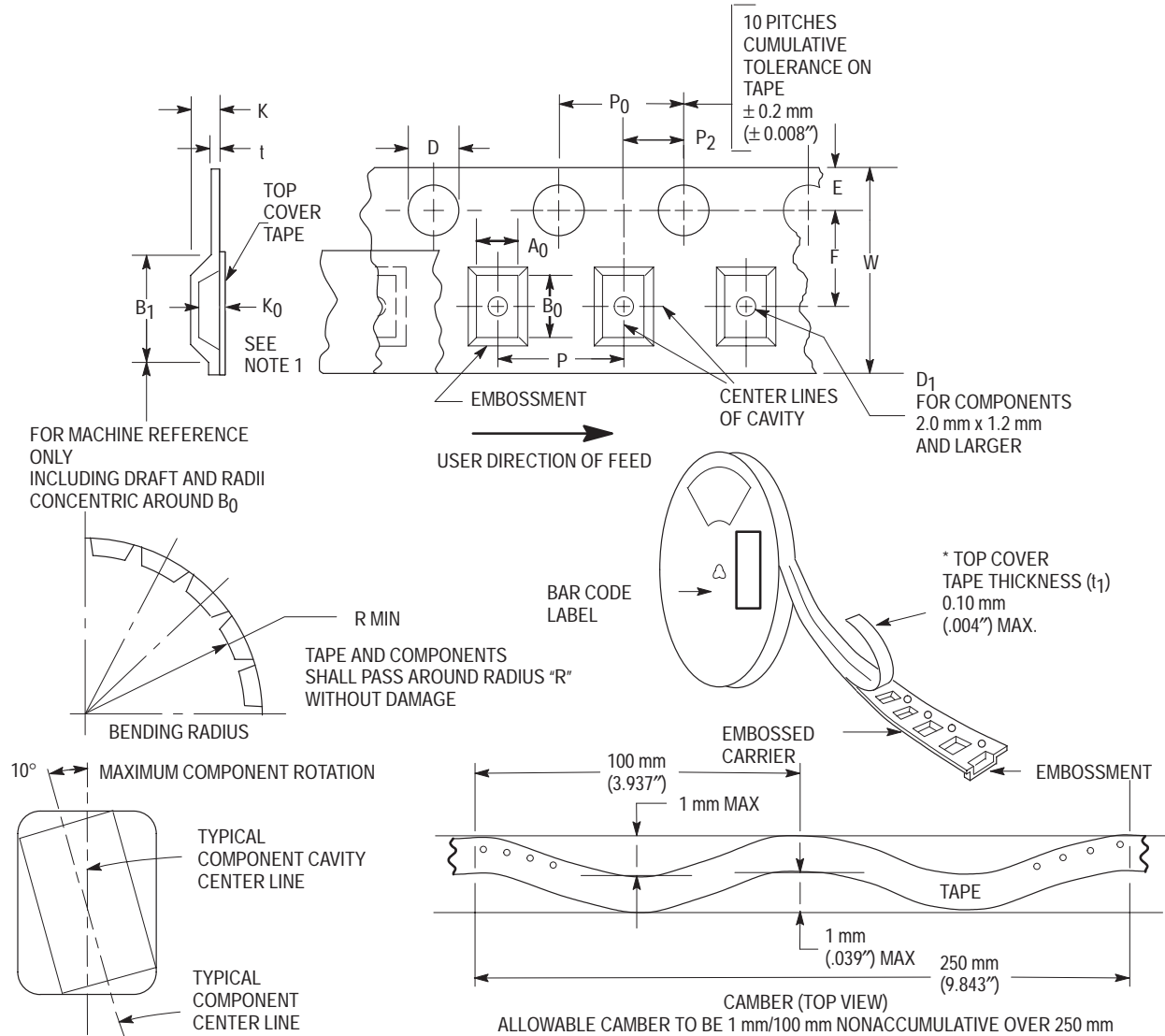
SMB, SMC  
12 mm 16 mm



Package	Case Type	Tape Width (mm)	Pitch <sup>(1)</sup>		Reel Size (inch)	Devices Per Reel and Minimum Order Quantity	Device Suffix
			(mm)	(in)			
SOD-123, SOT-23	Case 318-07	8	4.0 ± 0.1	.157 ± .004	7	3,000	T1
		8			13	10,000	T3
SMB	Case 403A	12	8.0 ± 0.1	.315 ± .004	13	2,500	T3
SMC	Case 403	16	8.0 ± 0.1	.315 ± .004	13	2,500	T3

<sup>(1)</sup> See p. 10-5.

## CARRIER TAPE SPECIFICATIONS



## DIMENSIONS

Tape Size	$B_1$ Max <sup>(2)</sup>	D	$D_1$	E	F	K	P	$P_0$	$P_2$	R Min	T Max	W Max
8 mm	4.55 mm (.179")	1.5 ± 0.1 mm -0.0 (.059 ± .004" -0.0)	1.0 Min (.039")	1.75 ± 0.1 mm (.069 ± .004")	3.5 ± 0.05 mm (.138 ± .002")	2.4 mm Max (.094")	4.0 ± 0.1 mm (.157 ± .004")	4.0 ± 0.1 mm (.157 ± .004")	2.0 ± 0.1 mm (.079 ± .002")	25 mm (.98")	0.6 mm (.024")	8.3 mm (.327")
12 mm	8.2 mm (.323")		1.5 mm Min (.060")		5.5 ± 0.05 mm (.217 ± .002")	6.4 mm Max (.252")	4.0 ± 0.1 mm (.157 ± .004") 8.0 ± 0.1 mm (.315 ± .004")			30 mm (1.18")		12 ± .30 mm (.470 ± .012")
16 mm	12.1 mm (.476")				7.5 ± 0.10 mm (.295 ± .004")	7.9 mm Max (.311")	4.0 ± 0.1 mm (.157 ± .004") 8.0 ± 0.1 mm (.315 ± .004") 12.0 ± 0.1 mm (.472 ± .004")					16.3 mm (.642")
24 mm	20.1 mm (.791")				11.5 ± 0.1 mm (.453 ± .004")	11.9 mm Max (.468")	16.0 ± 0.1 mm (.63 ± .004")					24.3 mm (.957")

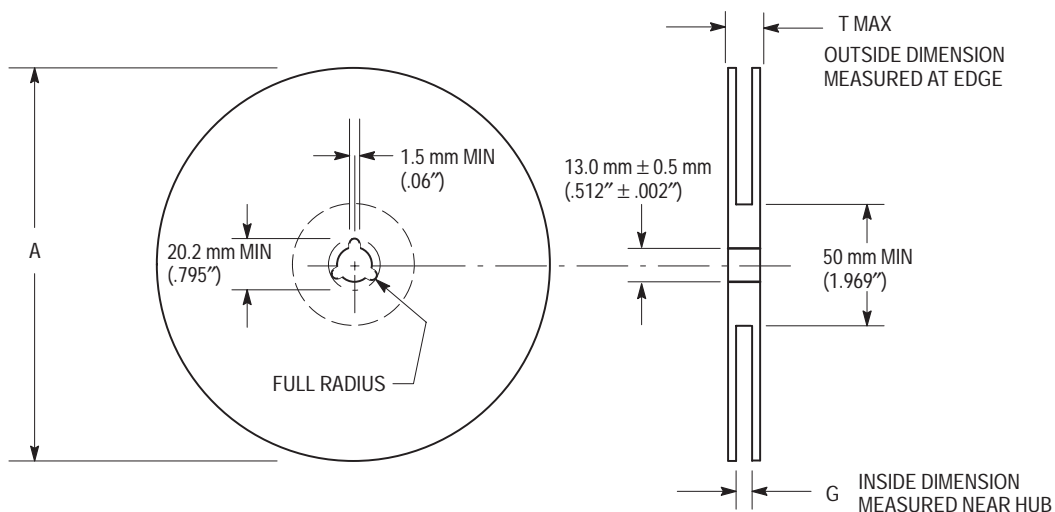
Metric dimensions govern — English are in parentheses for reference only.

NOTE 1:  $A_0$ ,  $B_0$ , and  $K_0$  are determined by component size. The clearance between the components and the cavity must be within .05 mm min. to .50 mm max., the component cannot rotate more than  $10^\circ$  within the determined cavity.

NOTE 2: If  $B_1$  exceeds 4.2 mm (.165) for 8 mm embossed tape, the tape may not feed through all tape feeders.

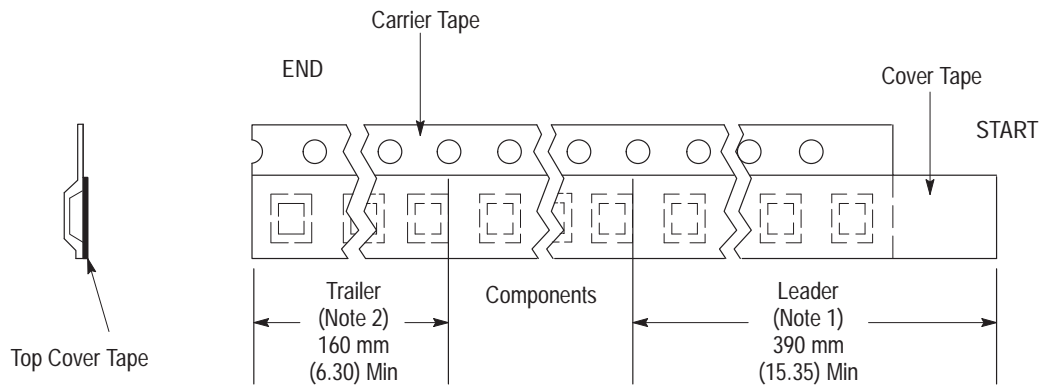
## REEL CONFIGURATION

Metric Dimensions Govern — English are in parentheses for reference only



Size	A Max	G	T Max
8 mm	330 mm (12.992")	8.4 mm + 1.5 mm, -0.0 (.33" + .059", -0.00)	14.4 mm (.56")
12 mm	330 mm (12.992")	12.4 mm + 2.0 mm, -0.0 (.49" + .079", -0.00)	18.4 mm (.72")
16 mm	360 mm (14.173")	16.4 mm + 2.0 mm, -0.0 (.646" + .078", -0.00)	22.4 mm (.882")
24 mm	360 mm (14.173")	24.4 mm + 2.0 mm, -0.0 (.961" + .070", -0.00)	30.4 mm (1.197")

## TAPE LEADER AND TRAILER DIMENSIONS



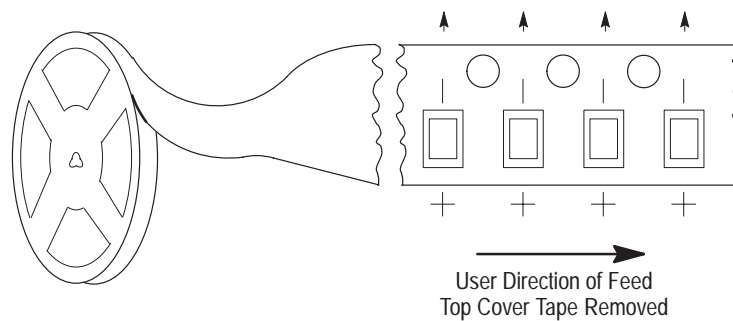
Metric dimensions govern

### NOTES

1. There shall be a leader of 230 mm (9.05) minimum which may consist of carrier and/or cover tape followed by a minimum of 160 mm (6.30) of empty carrier tape sealed with cover tape.
2. There shall be a trailer of 160 mm (6.30) minimum of empty carrier tape sealed with cover tape. The entire carrier tape must release from the reel hub as the last portion of the tape unwinds from the reel without damage to the carrier tape and the remaining components in the cavities.

## ELECTRICAL POLARIZATION

### TWO TERMINATION DEVICES



Metric dimensions govern

### NOTES

1. All polarized components must be oriented in one direction. For components with two terminations the cathode shall be adjacent to the sprocket hole side.





# Section Eleven

## Technical Information, Application Notes and Articles

<b>CHAPTER 1</b>	
Zener Diode Theory .....	11-2
<b>CHAPTER 2</b>	
Zener Diode Fabrication Techniques .....	11-7
<b>CHAPTER 3</b>	
Reliability .....	11-11
<b>CHAPTER 4</b>	
Zener Diode Characteristics .....	11-17
<b>CHAPTER 5</b>	
Temperature Compensated Zeners .....	11-29
<b>CHAPTER 6</b>	
Basic Voltage Regulation Using Zener Diodes .....	11-33
<b>CHAPTER 7</b>	
Zener Protective Circuits and Techniques: Basic Design Considerations .....	11-43
<b>CHAPTER 8</b>	
Zener Voltage Sensing Circuits and Applications .....	11-53
<b>CHAPTER 9</b>	
Miscellaneous Applications of Zener Type Devices .....	11-60
<b>CHAPTER 10</b>	
Transient Voltage Suppression .....	11-62
<b>CHAPTER 11</b>	
Application Notes .....	11-81
AN784 — Transient Power Capability of Zener Diodes .....	11-81
AN843 — A Review of Transients and Their Means of Suppression .....	11-83
Design Considerations and Performance of Motorola Temperature-Compensated Zener (Reference) Diodes .....	11-96
<b>CHAPTER 12</b>	
Articles .....	11-101
Some Straight Talk About Mosorbs Transient Voltage Suppressors .....	11-101
AR450 — Characterizing Overvoltage Transient Suppressors .....	11-105
Measurement of Zener Voltage to Thermal Equilibrium with Pulsed Test Circuit .....	11-118

# Chapter 1

## ZENER DIODE THEORY

### INTRODUCTION

The zener diode is a semiconductor device unique in its mode of operation and completely unreplaceable by any other electronic device. Because of its unusual properties it fills a long-standing need in electronic circuitry. It provides, among other useful functions, a constant voltage reference or voltage control element available over a wide spectrum of voltage and power levels.

The zener diode is unique among the semiconductor family of devices because its electrical properties are derived from a rectifying junction which operates in the reverse breakdown region. In the sections that follow, the reverse biased rectifying junction, some of the terms associated with it, and properties derived from it will be discussed fully.

The zener diode is fabricated from the element silicon. Special techniques are applied in the fabrication of zener diodes to create the required properties.

This manual was prepared to acquaint the engineer, the equipment designer and manufacturer, and the experimenter with the fundamental principles, design characteristics, applications and advantages of this important semiconductor device.

### SEMICONDUCTOR THEORY

The active portion of a zener diode is a semiconductor PN junction. PN junctions are formed in various kinds of semiconductor devices by several techniques. Among these are the widely used techniques known as alloying and diffusion which are utilized in fabricating zener PN junctions to provide excellent control over zener breakdown voltage.

At the present time, zener diodes use silicon as the basic material in the formation of their PN junction. Silicon is in Group IV of the periodic table (tetravalent) and is classed as a "semiconductor" due to the fact that it is a poor conductor in a pure state. When controlled amounts of certain "impurities" are added to a semiconductor it becomes a better conductor of electricity. Depending on the type of impurity added to the basic semiconductor, its conductivity may take two different forms, called P- and N-type respectively.

N-type conductivity in a semiconductor is much like the conductivity due to the drift of free electrons in a metal. In pure silicon at room temperature there are too few free electrons to conduct current. However, there are ways of introducing free electrons into the crystal lattice as we shall now see. Silicon is a tetravalent element, one with four

valence electrons in the outer shell; all are virtually locked into place by the covalent bonds of the crystal lattice structure, as shown schematically in Figure 1a. When controlled amounts of donor impurities (Group V elements) such as phosphorus are added, the pentavalent phosphorus atoms entering the lattice structure provide extra electrons not required by the covalent bonds. These impurities are called donor impurities since they "donate" a free electron to the lattice. These donated electrons are free to drift from negative to positive across the crystal when a field is applied, as shown in Figure 1b. The "N" nomenclature for this kind of conductivity implies "negative" charge carriers.

In P-type conductivity, the charges that carry electric current across the crystal act as if they were positive charges. We know that electricity is always carried by drifting electrons in any material, and that there are no mobile positively charged carriers in a solid. Positive charge carriers can exist in gases and liquids in the form of positive ions but not in solids. The positive character of the current flow in the semiconductor crystal may be thought of as the movement of vacancies (called holes) in the covalent lattice. These holes drift from positive toward negative in an electric field, behaving as if they were positive carriers.

P-type conductivity in semiconductors result from adding acceptor impurities (Group III elements) such as boron to silicon to the semiconductor crystal. In this case, boron atoms, with three valence electrons, enter the tetravalent silicon lattice. Since the covalent bonds cannot be satisfied by only three electrons, each acceptor atom leaves a hole in the lattice which is deficient by one electron. These holes readily accept electrons introduced by external sources or created by radiation or heat, as shown in Figure 1c. Hence the name acceptor ion or acceptor impurity. When an external circuit is connected, electrons from the current source "fill up" these holes from the negative end and jump from hole to hole across the crystal or one may think of this process in a slightly different but equivalent way, that is as the displacement of positive holes toward the negative terminal. It is this drift of the positively charged holes which accounts for the term P-type conductivity.

When semiconductor regions of N- and P-type conductivities are formed in a semiconductor crystal adjacent to each other, this structure is called a PN junction. Such a junction is responsible for the action of both zener diodes and rectifier devices, and will be discussed in the next section.

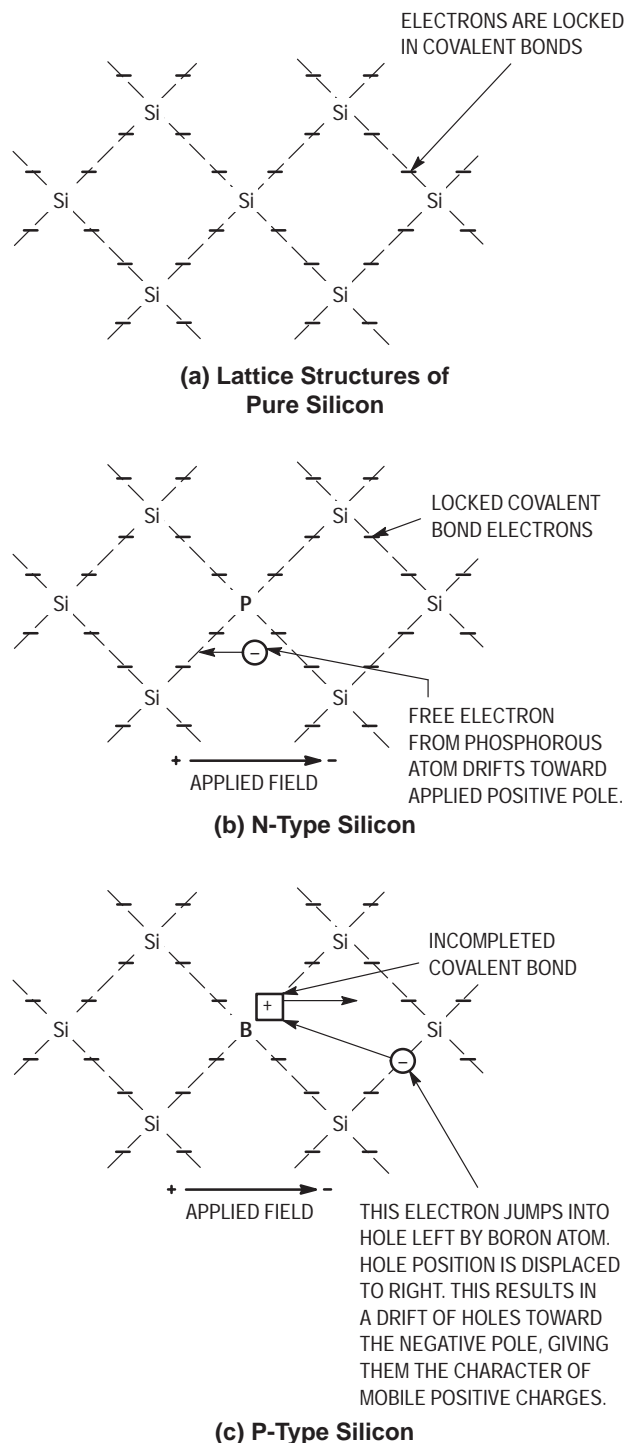


Figure 1. Semiconductor Structure

## THE SEMICONDUCTOR DIODE

In the forward-biased PN junction, Figure 2a, the P region is made more positive than the N region by an external circuit. Under these conditions there is a very low resistance to current flow in the circuit. This is because the holes in the positive P-type material are very readily attracted across the junction interface toward the negative N-type side.

Conversely, electrons in the N-type are readily attracted by the positive polarity in the other direction.

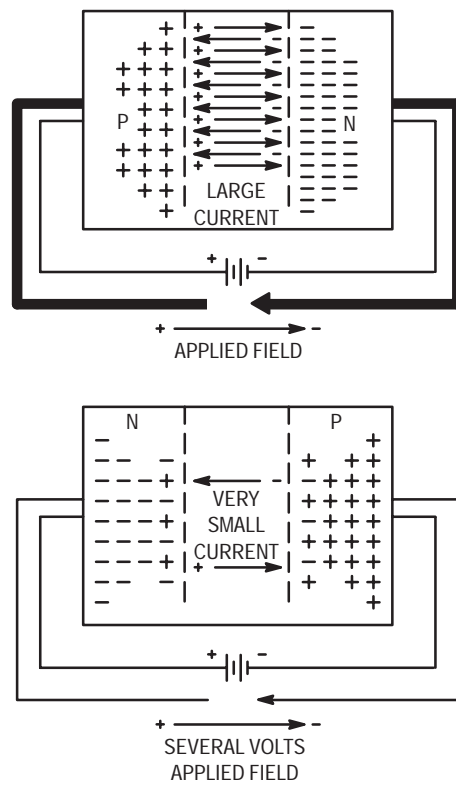
When a PN junction is reverse biased, the P-type side is made more negative than the N-type side. (See Figure 2b.) At voltages below the breakdown of the junction, there is very little current flow across the junction interface. At first thought one would expect no reverse current under reverse bias conditions, but several effects are responsible for this small current.

Under this condition the positive holes in the P-type semiconductor are repelled from the junction interface by the positive polarity applied to the N side, and conversely, the electrons in the N material are repelled from the interface by the negative polarity of the P side. This creates a region extending from the junction interface into both P- and N-type materials which is completely free of charge carriers, that is, the region is depleted of its charge carriers. Hence, this region is usually called the depletion region.

Although the region is free of charge *carriers*, the P-side of the depletion region will have an excess negative charge due to the presence of acceptor ions which are, of course, fixed in the lattice; while the N-side of the depletion region has an excess positive charge due to the presence of donor ions. These opposing regions of charged ions create a strong electric field across the PN junction responsible for the creation of reverse current.

The semiconductor regions are never perfect; there are always a few free electrons in P material and few holes in N material. A more significant factor, however, is the fact that great magnitudes of electron-hole pairs may be thermally generated at room temperatures in the semiconductor. When these electron-hole pairs are created within the depletion region, then the intense electric field mentioned in the above paragraph will cause a small current to flow. This small current is called the reverse saturation current, and tends to maintain a relatively constant value for a fixed temperature at all voltages. The reverse saturation current is usually negligible compared with the current flow when the junction is forward biased. Hence, we see that the PN junction, when not reverse biased beyond breakdown voltage, will conduct heavily in only one direction. When this property is utilized in a circuit we are employing the PN junction as a rectifier. Let us see how we can employ its reverse breakdown characteristics to an advantage.

As the reverse voltage is increased to a point called the voltage breakdown point and beyond, current conduction across the junction interface increases rapidly. The break from a low value of the reverse saturation current to heavy conductance is very sharp and well defined in most PN junctions. It is called the zener knee. When reverse voltages greater than the voltage breakdown point are applied to the PN junction, the voltage drop across the PN junction remains essentially constant at the value of the breakdown voltage for a relatively wide range of currents. This region beyond the voltage breakdown point is called the zener control region.



CHARGES FROM BOTH P AND N REGIONS DRIFT ACROSS JUNCTION AT VERY LOW APPLIED VOLTAGES.

**(a) Forward-Biased PN Junction**

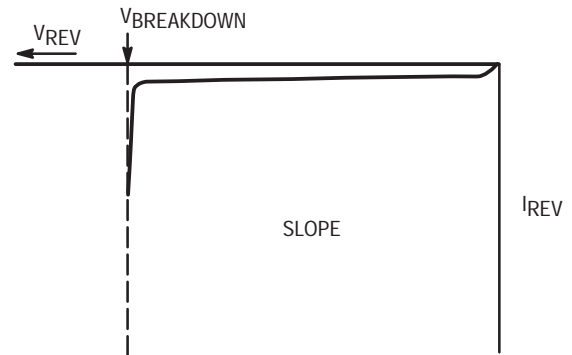
AT APPLIED VOLTAGES BELOW THE CRITICAL BREAKDOWN LEVEL ONLY A FEW CHARGES DRIFT ACROSS THE INTERFACE.

**(b) Reverse-Biased PN Junction**

**Figure 2. Effects of Junction Bias**

**ZENER CONTROL REGION: VOLTAGE BREAKDOWN MECHANISMS**

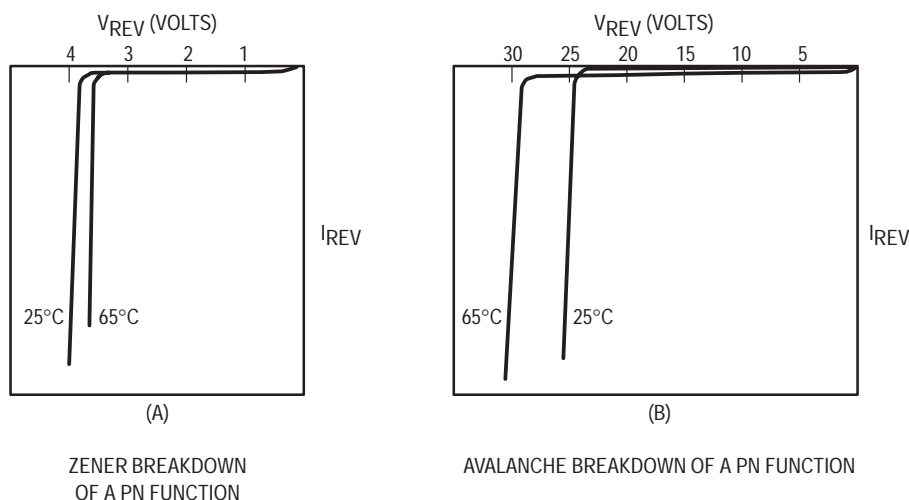
Figure 3 depicts the extension of reverse biasing to the point where voltage breakdown occurs. Although all PN junctions exhibit a voltage breakdown, it is important to know that there are two distinct voltage breakdown mechanisms. One is called *zener breakdown* and the other is called *avalanche breakdown*. In zener breakdown the value of breakdown voltage decreases as the PN junction temperature increases; while in avalanche breakdown the value of the breakdown voltage increases as the PN junction temperature increases. Typical diode breakdown characteristics of each category are shown in Figure 4. The factor determining which of the two breakdown mechanisms occurs is the relative concentrations of the impurities in the materials which comprise the junction. If two different resistivity P-type materials are placed against two separate but equally doped low-resistivity pieces of N-type materials, the depletion region spread in the low resistivity P-type material will be smaller than the depletion region spread in the high resistivity P-type material. Moreover, in both situations little of the resultant depletion width lies in the N material if its resistivity is low compared to the P-type material. In other words, the depletion region always spreads principally into the material having the highest resistivity. Also, the electric field (voltage per unit length) in the less resistive material is greater than the electric field in the material of greater resistivity due to the presence of more



**Figure 3. Reverse Characteristic Extended to Show Breakdown Effect**

ions/unit volume in the less resistive material. A junction that results in a narrow depletion region will therefore develop a high field intensity and breakdown by the zener mechanism. A junction that results in a wider depletion region and, thus, a lower field intensity will break down by the avalanche mechanism before a zener breakdown condition can be reached.

The zener mechanism can be described qualitatively as follows: because the depletion width is very small, the application of low reverse bias (5 volts or less) will cause a field across the depletion region on the order of  $3 \times 10^5 \text{V/cm}$ . A field of such high magnitude exerts a large force



**Figure 4. Typical Breakdown Diode Characteristics. Note Effects of Temperature for Each Mechanism**

on the valence electrons of a silicon atom, tending to separate them from their respective nuclei. Actual rupture of the covalent bonds occurs when the field approaches  $3 \times 10^5 \text{V/cm}$ . Thus, electron-hole pairs are generated in large numbers and a sudden increase of current is observed. Although we speak of a rupture of the atomic structure, it should be understood that this generation of electron-hole pairs may be carried on continuously as long as an external source supplies additional electrons. If a limiting resistance in the circuit external to the diode junction does not prevent the current from increasing to high values, the device may be destroyed due to overheating. The actual critical value of field causing zener breakdown is believed to be approximately  $3 \times 10^5 \text{V/cm}$ . On most commercially available silicon diodes, the maximum value of voltage breakdown by the zener mechanism is 8 volts. In order to fabricate devices with higher voltage breakdown characteristics, materials with higher resistivity, and consequently, wider depletion regions are required. These wide depletion regions hold the field strength down below the zener breakdown value ( $3 \times 10^5 \text{V/cm}$ ). Consequently, for devices with breakdown voltage lower than 5 volts the zener mechanism predominates, between 5 and 8 volts both zener and an avalanche mechanism are involved, while above 8 volts the avalanche mechanism alone takes over.

The decrease of zener breakdown voltage as junction temperature increases can be explained in terms of the energies of the valence electrons. An increase of temperature increases the energies of the valence electrons. This weakens the bonds holding the electrons and consequently, less applied voltage is necessary to pull the valence electrons from their position around the nuclei. Thus, the breakdown voltage decreases as the temperature increases.

The dependence on temperature of the avalanche breakdown mechanism is quite different. Here the depletion region is of sufficient width that the carriers (electrons or holes) can suffer collisions before traveling the region

completely i.e., the depletion region is wider than one mean-free path (the average distance a carrier can travel before combining with a carrier of opposite conductivity). Therefore, when temperature is increased, the increased lattice vibration shortens the distance a carrier travels before colliding and thus requires a higher voltage to get it across the depletion region.

As established earlier, the applied reverse bias causes a small movement of intrinsic electrons from the P material to the potentially positive N material and intrinsic holes from the N material to the potentially negative P material (leakage current). As the applied voltage becomes larger, these electrons and holes increasingly accelerate. There are also collisions between these intrinsic particles and bound electrons as the intrinsic particles move through the depletion region. If the applied voltage is such that the intrinsic electrons do not have high velocity, then the collisions take some energy from the intrinsic particles, altering their velocity. If the applied voltage is increased, collision with a valence electron will give considerable energy to the electron and it will break free of its covalent bond. Thus, one electron by collision, has created an electron-hole pair. These secondary particles will also be accelerated and participate in collisions which generate new electron-hole pairs. This phenomenon is called carrier multiplication. Electron-hole pairs are generated so quickly and in such large numbers that there is an apparent avalanche or self-sustained multiplication process (depicted graphically in Figure 5). The junction is said to be in breakdown and the current is limited only by resistance external to the junction. Zener diodes above 7 to 8 volts exhibit avalanche breakdown.

As junction temperature increases, the voltage breakdown point for the avalanche mechanism increases. This effect can be explained by considering the vibration displacement of atoms in their lattice increases, and this increased displacement corresponds to an increase in the probability that intrinsic particles in the depletion region will collide with the lattice atoms. If the probability of an intrinsic particle-atom

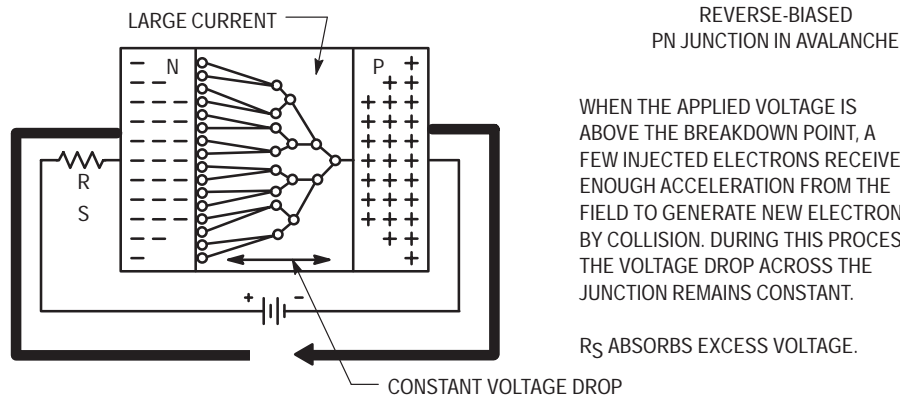


Figure 5. PN Junction in Avalanche Breakdown

collision increases, then the probability that a given intrinsic particle will obtain high momentum decreases, and it follows that the low momentum intrinsic particles are less likely to ionize the lattice atoms. Naturally, increased voltage increases the acceleration of the intrinsic particles, providing higher mean momentum and more electron-hole pairs production. If the voltage is raised sufficiently, the mean momentum becomes great enough to create electron-hole pairs and carrier multiplication results. Hence, for increasing temperature, the value of the avalanche breakdown voltage increases.

**VOLT-AMPERE CHARACTERISTICS**

The zener volt-ampere characteristics for a typical 30 volt zener diode is illustrated in Figure 6. It shows that the zener diode conducts current in both directions; the forward current  $I_F$  being a function of forward voltage  $V_F$ . Note that  $I_F$  is small until  $V_F \approx 0.65$  V; then  $I_F$  increases very rapidly. For  $V_F > 0.65$  V  $I_F$  is limited primarily by the circuit resistance external to the diode.

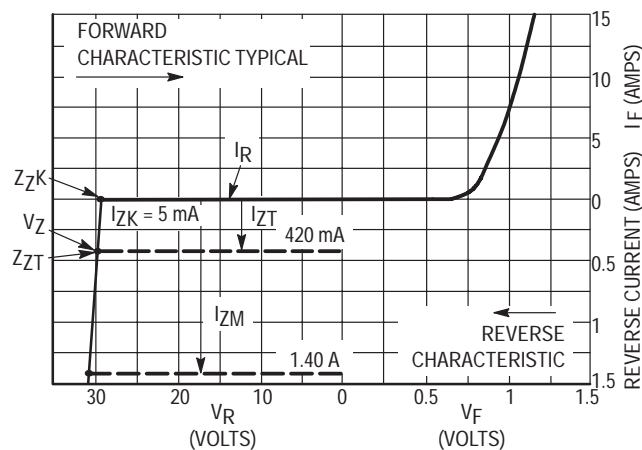


Figure 6. Zener Diode Characteristics

The reverse current is a function of the reverse voltage  $V_R$  but for most practical purposes is zero until the reverse voltage approaches  $V_Z$ , the PN junction breakdown voltage, at which time the reverse current increases very

rapidly. Since the reverse current is small for  $V_R < V_Z$ , but great for  $V_R > V_Z$  each of the current regions is specified by a different symbol. For the leakage current region, i.e. non-conducting region, between 0 volts and  $V_Z$ , the reverse current is denoted by the symbol  $I_R$ ; but for the zener control region,  $V_R \geq V_Z$ , the reverse current is denoted by the symbol  $I_Z$ .  $I_R$  is usually specified at a reverse voltage  $V_R \approx 0.8 V_Z$ .

The PN junction breakdown voltage,  $V_Z$ , is usually called the zener voltage, regardless whether the diode is of the zener or avalanche breakdown type. Commercial zener diodes are available with zener voltages from about 1.8 V – 400 V. For most applications the zener diode is operated well into the breakdown region ( $I_{ZT}$  to  $I_{ZM}$ ). Most manufacturers give an additional specification of  $I_{ZK}$  (= 5 mA in Figure 6) to indicate a minimum operating current to assure reasonable regulation.

This minimum current  $I_{ZK}$  varies in the various types of zener diodes and, consequently, is given on the data sheets. The maximum zener current  $I_{ZM}$  should be considered the maximum reverse current recommended by the manufacturer. Values of  $I_{ZM}$  are usually given in the data sheets.

Between the limits of  $I_{ZK}$  and  $I_{ZM}$ , which are 5 mA and 1400 mA (1.4 Amperes) in the example of Figure 6, the voltage across the diode is essentially constant, and  $\approx V_Z$ . This plateau region has, however, a large positive slope such that the precise value of reverse voltage will change slightly as a function of  $I_Z$ . For any point on this plateau region one may calculate an impedance using the incremental magnitudes of the voltage and current. This impedance is usually called the zener impedance  $Z_Z$ , and is specified for most zener diodes. Most manufacturers measure the maximum zener impedance at two test points on the plateau region. The first is usually near the knee of the zener plateau,  $Z_{ZK}$ , and the latter point near the midrange of the usable zener current excursion. Two such points are illustrated in Figure 6.

This section was intended to introduce the reader to a few of the major terms used with zener diodes. A complete description of these terms may be found in chapter four. In chapter four a full discussion of zener leakage, DC breakdown, zener impedance, temperature coefficients and many other topics may be found.

## Chapter 2

# ZENER DIODE FABRICATION TECHNIQUES

### INTRODUCTION

A brief exposure to the techniques used in the fabrication of zener diodes can provide the engineer with additional insight using zeners in their applications. That is, an understanding of zener fabrication makes the capabilities and limitations of the zener diode more meaningful. This chapter discusses the basic steps in the fabrication of the zener from crystal growing through final testing.

### ZENER DIODE WAFER FABRICATION

The major steps in the manufacture of zeners are provided in the process flow in Figure 1. It is important to point out that the manufacturing steps vary somewhat from manufacturer to manufacturer, and also vary with the type of zener diode produced. This is driven by the type of package required as well as the electrical characteristics desired. For example, alloy diffused devices provide excellent low voltage reference with low leakage

characteristics but do not have the same surge carrying capability as diffused diodes. The manufacturing process begins with the growing of high quality silicon crystals.

Crystals for Motorola zener diodes are grown using the Czochralski technique, a widely used process which begins with ultra-pure polycrystalline silicon. The polycrystalline silicon is first melted in a nonreactive crucible held at a temperature just above the melting point. A carefully controlled quantity of the desired dopant impurity, such as phosphorus or boron is added. A high quality seed crystal of the desired crystalline orientation is then lowered into the melt while rotating. A portion of this seed crystal is allowed to melt into the molten silicon. The seed is then slowly pulled and continues to rotate as it is raised from the melt. As the seed is raised, cooling takes place and material from the melt adheres to it, thus forming a single crystal ingot. With this technique, ingots with diameters of several inches can be fabricated.

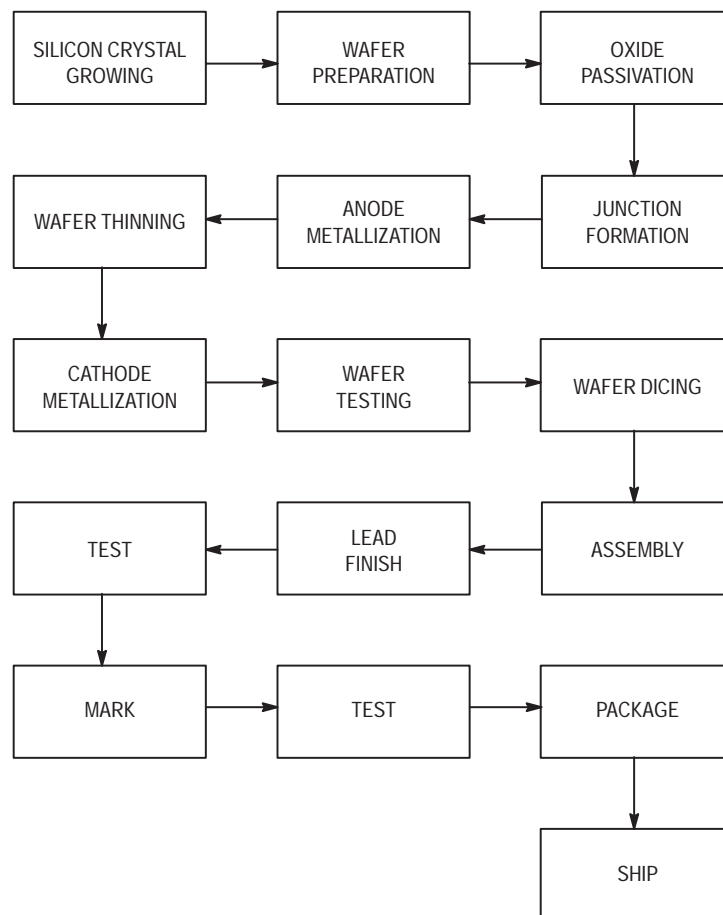
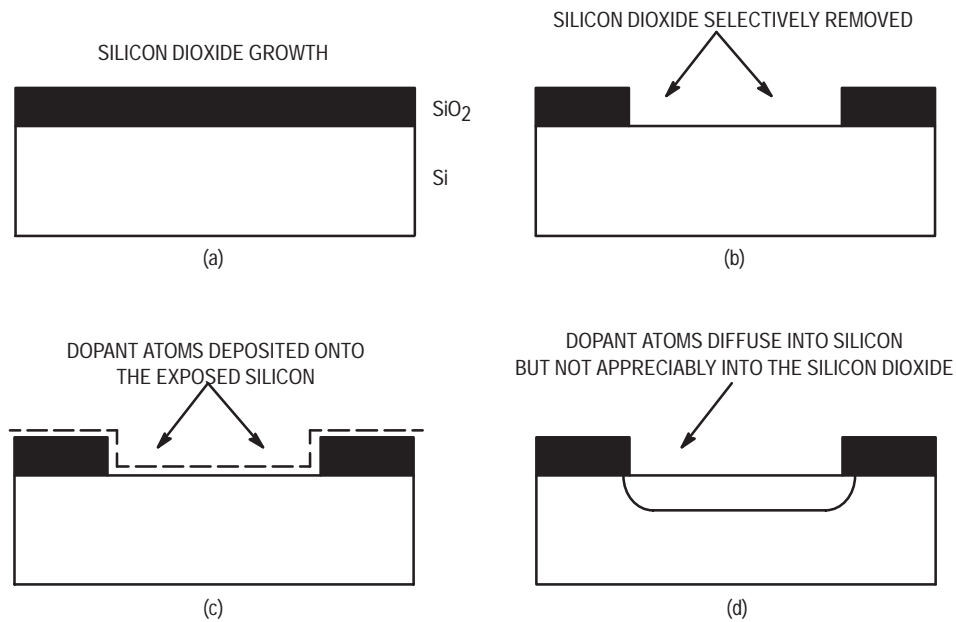


Figure 1. General Flow of the Zener Diode Process





**Figure 2. Basic Fabrication Steps in the Silicon Planar Process: a) oxide formation, b) selective oxide removal, c) deposition of dopant atoms, d) junction formation by diffusion of dopant atoms.**

Once the single-crystal silicon ingot is grown, it is tested for doping concentration (resistivity), undesired impurity levels, and minority carrier lifetime. The ingot is then sliced into thin, circular wafers. The wafers are then chemically etched to remove saw damage and polished in a sequence of successively finer polishing grits until a mirror-like defect free surface is obtained. The wafers are then cleaned and placed in vacuum sealed wafer carriers to prevent any contamination from getting on them. At this point, the wafers are ready to begin device fabrication.

Zener diodes can be manufactured using different processing techniques such as planar processing or mesa etched processing. The majority of Motorola zener diodes are manufactured using the planar technique as shown in Figure 2.

The planar process begins by growing an ultra-clean protective silicon dioxide passivation layer. The oxide is typically grown in the temperature range of 900 to 1200 degrees celcius. Once the protective layer of silicon dioxide has been formed, it must be selectively removed from those areas into which dopant atoms will be introduced. This is done using photolithographic techniques.

First a light sensitive solution called photo resist is spun onto the wafer. The resist is then dried and a photographic negative or mask is placed over the wafer. The resist is then exposed to ultraviolet light causing the molecules in it to cross link or polymerize becoming very rigid. Those areas of the wafer that are protected by opaque portions of the mask are not exposed and are developed away. The oxide is then etched forming the exposed regions in which the dopant will be introduced. The remaining resist is then removed and the wafers carefully cleaned for the doping steps.

Dopant is then introduced onto the wafer surface using various techniques such as aluminum alloy for low voltage devices, ion-implantation, spin-on dopants, or chemical vapor deposition. Once the dopant is deposited, the junctions are formed in a subsequent high temperature (1100 to 1250 degrees celcius are typical) drive-in. The resultant junction profile is determined by the background concentration of the starting substrate, the amount of dopant placed at the surface, and amount of time and temperature used during the dopant drive-in. This junction profile determines the electrical characteristics of the device. During the drive-in cycle, additional passivation oxide is grown providing additional protection for the devices.

After junction formation, the wafers are then processed through what is called a getter process. The getter step utilizes high temperature and slight stress provided by a highly doped phosphosilicate glass layer introduced into the backside of the wafers. This causes any contaminants in the area of the junction to diffuse away from the region. This serves to improve the reverse leakage characteristic and the stability of the device. Following the getter process, a second photo resist step opens the contact area in which the anode metallization is deposited.

Metal systems for Motorola's zener diodes are determined by the requirements of the package. The metal systems are deposited in ultra-clean vacuum chambers utilizing electron-beam evaporation techniques. Once the metal is deposited, photo resist processing is utilized to form the desired patterns. The wafers are then lapped to their final thickness and the cathode metallization deposited using the same e-beam process.

The quality of the wafers is closely monitored throughout the process by using statistical process control techniques

and careful microscopic inspections at critical steps. Special wafer handling equipment is used throughout the manufacturing process to minimize contamination and to avoid damaging the wafers in any way. This further enhances the quality and stability of the devices.

Upon completion of the fabrication steps, the wafers are electrically probed, inspected, and packaged for shipment to the assembly operations. All Motorola zener diode product is sawn using 100% saw-through techniques stringently developed to provide high quality silicon die.

**ZENER DIODE ASSEMBLY**

**Surmetic 30, 40 and MOSORB**

The plastic packages (Surmetic 30, 40 and MOSORBs) are assembled using oxygen free high conductivity copper leads for efficient heat transfer from the die and allowing maximum power dissipation with a minimum of external heatsinking. Figure 3 shows typical assembly. The leads are of nail head construction, soldered directly to the die, which further enhances the heat dissipating capabilities of the package.

The Surmetic 30s, 40s and MOSORBs are basically assembled in the same manner; the only difference being the MOSORBs are soldered together using a solder disc between the lead and die whereas the Surmetic 30s and Surmetic 40s utilize pre-soldered leads.

Assembly is started on the Surmetic 30 and 40 by loading the leads into assembly boats and pre-soldering the nail heads. After pre-soldering, one die is then placed into each cavity of one assembly boat and another assembly boat is then mated to it. Since the MOSORBs do not use pre-soldered leads, the leads are put into the assembly boat, a solder disc is placed into each cavity and then a die is

put in on top. A solder disc is put in on top of the die. Another assembly boat containing only leads is mated to the boat containing the leads, die, and two solder discs. The boats are passed through the assembly furnace; this operation requires only one pass through the furnace.

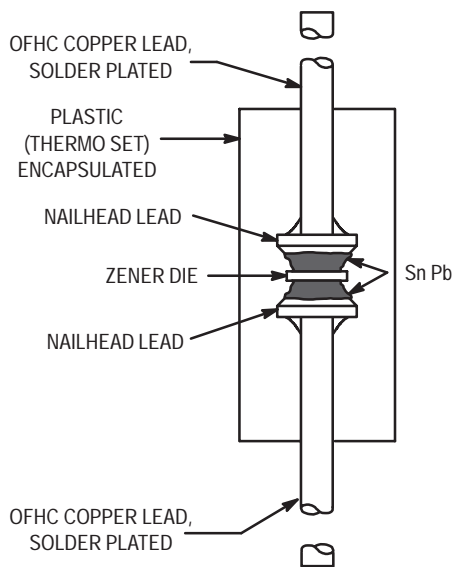
After assembly, the leads on the Surmetic 30s, 40s and MOSORBs are plated with a tin-lead alloy making them readily solderable and corrosion resistant.

**Double Slug (DO-35 and DO-41)**

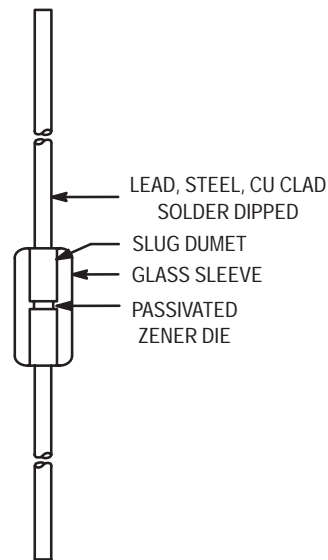
Double slugs receive their name from the dumet slugs, one attached to one end of each lead. These slugs sandwich the pre-tinned die between them and are hermetically sealed to the glass envelope or body during assembly. Figure 4 shows typical assembly.

The assembly begins with the copper clad steel leads being loaded into assembly "boats." Every other boat load of leads has a glass body set over the slug. A pre-tinned die is placed into each glass body and the other boat load of leads is mated to the boat holding the leads, body and die. These mated boats are then placed into the assembly furnace where the total mass is heated. Each glass body melts; and as the boat proceeds through the cooling portion of the furnace chamber, the tin which has wetted to each slug solidifies forming a bond between the die and both slugs. The glass hardens, attaching itself to the sides of the two slugs forming the hermetic seal. The above illustrates how the diodes are completely assembled using a single furnace pass minimizing assembly problems.

The encapsulated devices are then processed through lead finish. This consists of dipping the leads in molten tin/lead solder alloy. The solder dipped leads produce an external finish which is tarnish-resistant and very solderable.



**Figure 3. Double-Slug Plastic Zener Construction**



**Figure 4. Double Slug Glass Zener Construction**

## ZENER DIODE TEST, MARK AND PACKAGING

### Double Slug, Surmetic 30, 40 and MOSORB

After lead finish, all products are final tested, whether they are double slug or of Surmetic construction, all are 100 percent final tested for zener voltage, leakage current, impedance and forward voltage drop.

Process average testing is used which is based upon the averages of the previous lots for a given voltage line and package type. Histograms are generated for the various

parameters as the units are being tested to ensure that the lot is testing well to the process average and compared against other lots of the same voltage.

After testing, the units are marked as required by the specification. The markers are equipped to polarity orient the devices as well as perform 100% redundant test prior to packaging.

After marking, the units are packaged either in "bulk" form or taped and reeled or taped and ammo packed to accommodate automatic insertion.

# Chapter 3 RELIABILITY

## INTRODUCTION

Motorola's Quality System maintains "continuous product improvement" goals in all phases of the operation. Statistical process control (SPC), quality control sampling, reliability audits and accelerated stress testing techniques monitor the quality and reliability of its products. Management and engineering skills are continuously upgraded through training programs. This maintains a unified focus on Six Sigma quality and reliability from the inception of the product to final customer use.

## STATISTICAL PROCESS CONTROL

Motorola's Discrete Group is continually pursuing new ways to improve product quality. Initial design improvement is one method that can be used to produce a superior product. Equally important to outgoing product quality is the ability to produce product that consistently conforms to specification. Process variability is the basic enemy of semiconductor manufacturing since it leads to product variability. Used in all phases of Motorola's product manufacturing, STATISTICAL PROCESS CONTROL (SPC) replaces variability with predictability. The traditional philosophy in the semiconductor industry has been adherence to the data sheet specification. Using SPC methods assures the product will meet specific process requirements throughout the manufacturing cycle. The emphasis is on defect prevention, not detection. Predictability through SPC methods requires the manufacturing culture to focus on constant and permanent improvements. Usually these improvements cannot be bought with state-of-the-art equipment or automated factories. With quality in design, process and material selection, coupled with manufacturing predictability, Motorola can produce world class products.

The immediate effect of SPC manufacturing is predictability through process controls. Product centered and distributed well within the product specification benefits Motorola with fewer rejects, improved yields and lower cost. The direct benefit to Motorola's customers includes better incoming quality levels, less inspection time and ship-to-stock capability. Circuit performance is often dependent on the cumulative effect of component variability. Tightly controlled component distributions give the customer greater circuit predictability. Many customers are also converting to just-in-time (JIT) delivery programs. These programs require improvements in cycle time and yield predictability achievable only through SPC techniques. The benefit derived from SPC helps the manufacturer meet the customer's expectations of higher quality and lower cost product.

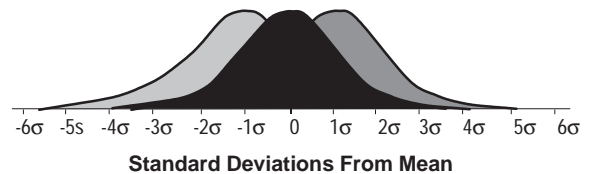
Ultimately, Motorola will have Six Sigma capability on all products. This means parametric distributions will be

centered within the specification limits with a product distribution of plus or minus Six Sigma about mean. Six Sigma capability, shown graphically in Figure 1, details the benefit in terms of yield and outgoing quality levels. This compares a centered distribution versus a 1.5 sigma worst case distribution shift.

New product development at Motorola requires more robust design features that make them less sensitive to minor variations in processing. These features make the implementation of SPC much easier.

A complete commitment to SPC is present throughout Motorola. All managers, engineers, production operators, supervisors and maintenance personnel have received multiple training courses on SPC techniques. Manufacturing has identified 22 wafer processing and 8 assembly steps considered critical to the processing of zener products. Processes, controlled by SPC methods, that have shown significant improvement are in the diffusion, photolithography and metallization areas.

To better understand SPC principles, brief explanations have been provided. These cover process capability, implementation and use.



Distribution Centered	Distribution Shifted $\pm 1.5$
At $\pm 3 \sigma$ 2700 ppm defective 99.73% yield	66810 ppm defective 93.32% yield
At $\pm 4 \sigma$ 63 ppm defective 99.9937% yield	6210 ppm defective 99.379% yield
At $\pm 5 \sigma$ 0.57 ppm defective 99.999943% yield	233 ppm defective 99.9767% yield
At $\pm 6 \sigma$ 0.002 ppm defective 99.9999998% yield	3.4 ppm defective 99.99966% yield

Figure 1. AOQL and Yield from a Normal Distribution of Product With  $6\sigma$  Capability

## PROCESS CAPABILITY

One goal of SPC is to ensure a process is **CAPABLE**. Process capability is the measurement of a process to produce products consistently to specification requirements. The purpose of a process capability study is to separate the inherent **RANDOM VARIABILITY** from **ASSIGNABLE CAUSES**. Once completed, steps are taken to identify and eliminate the most significant assignable causes. Random variability is generally present in the system and does not fluctuate. Sometimes, these are considered basic limitations associated with the machinery, materials, personnel skills or manufacturing methods. Assignable cause inconsistencies relate to time variations in yield, performance or reliability.

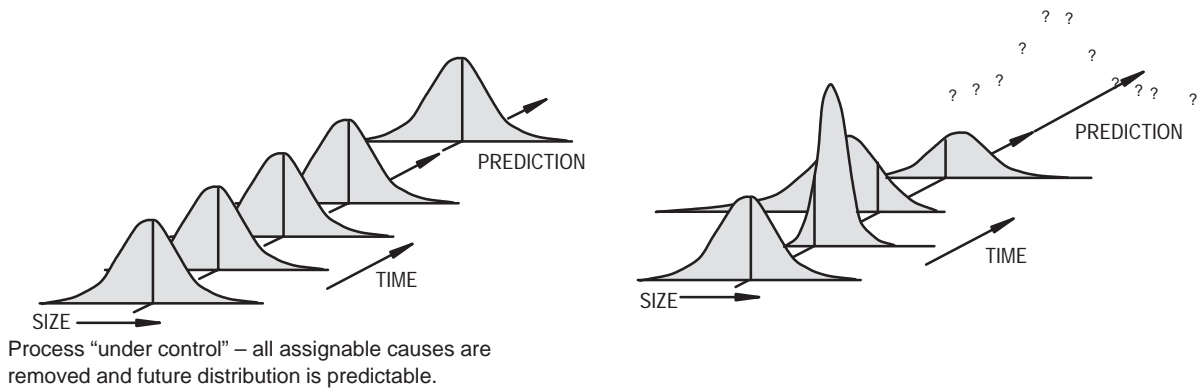


Figure 2. Impact of Assignable Causes on Process Predictable

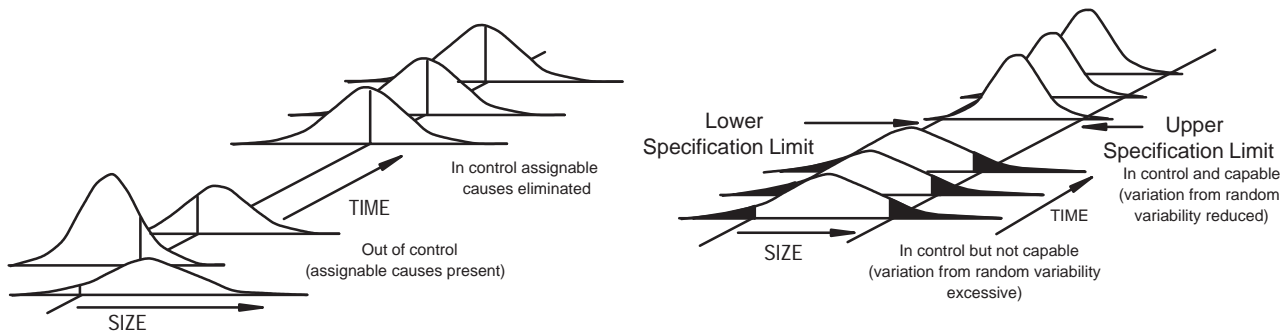


Figure 3. Difference Between Process Control and Process Capability

Traditionally, assignable causes appear to be random due to the lack of close examination or analysis. Figure 2 shows the impact on predictability that assignable cause can have. Figure 3 shows the difference between process control and process capability.

A process capability study involves taking periodic samples from the process under controlled conditions. The performance characteristics of these samples are charted against time. In time, assignable causes can be identified and engineered out. Careful documentation of the process is key to accurate diagnosis and successful removal of the assignable causes. Sometimes, the assignable causes will remain unclear requiring prolonged experimentation.

Elements which measure process variation control and capability are Cp and Cpk respectively. Cp is the specification width divided by the process width or  $Cp = (\text{specification width}) / 6\sigma$ . Cpk is the absolute value of the closest specification value to the mean, minus the mean, divided by half the process width or  $Cpk = |\text{closest specification} - \bar{X}| / 3\sigma$ .

At Motorola, for critical parameters, the process capability is acceptable with a  $Cpk = 1.33$ . The desired process capability is a  $Cpk = 2$  and the ideal is a  $Cpk = 5$ . Cpk, by definition, shows where the current production process fits with relationship to the specification limits. Off center distributions or excessive process variability will result in less than optimum conditions.

### SPC IMPLEMENTATION AND USE

The Discrete Group uses many parameters that show conformance to specification. Some parameters are sensitive to process variations while others remain constant for a given product line. Often, specific parameters are influenced when changes to other parameters occur. It is both impractical and unnecessary to monitor all parameters using SPC methods. Only critical parameters that are sensitive to process variability are chosen for SPC monitoring. The process steps affecting these critical parameters must be identified also. It is equally important to find a measurement in these process steps that correlates with product performance. This is called a critical process parameter.

Once the critical process parameters are selected, a sample plan must be determined. The samples used for measurement are organized into **RATIONAL SUBGROUPS** of approximately 2 to 5 pieces. The subgroup size should be such that variation among the samples within the subgroup remain small. All samples must come from the same source e.g., the same mold press operator, etc.. Subgroup data should be collected at appropriate time intervals to detect variations in the process. As the process begins to show improved stability, the interval may be increased. The data collected must be carefully documented and maintained for later correlation. Examples of common documentation entries would include operator, machine, time, settings, product type, etc..

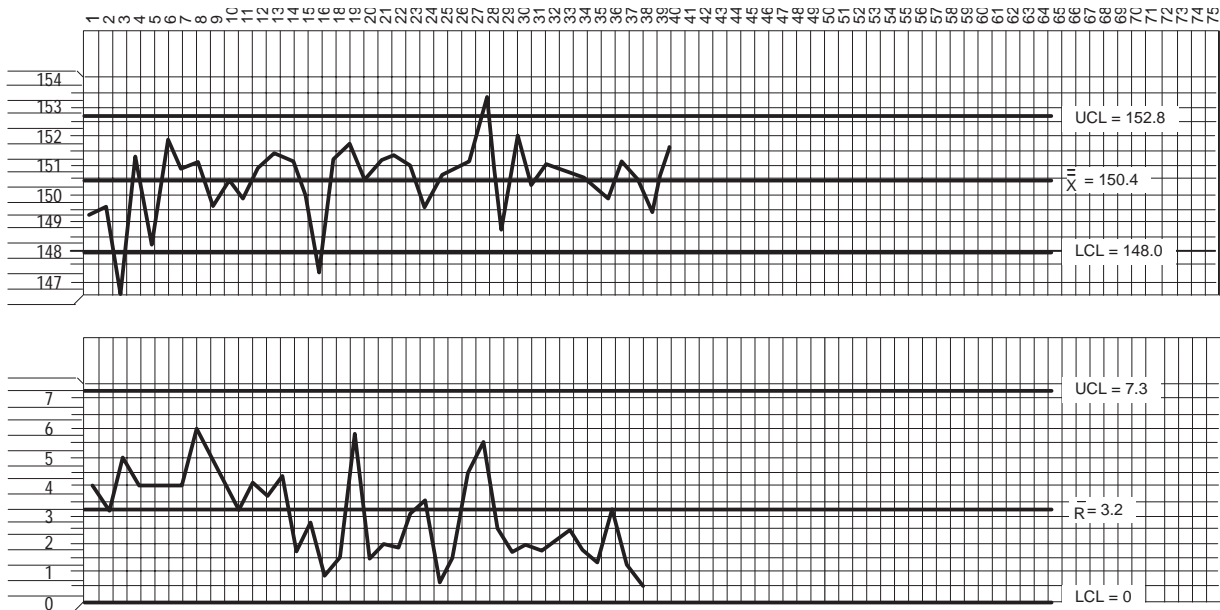


Figure 4. Example of Process Control Chart Showing Oven Temperature Data

Once the plan is established, data collection may begin. The data collected will generate  $\bar{X}$  and  $R$  values that are plotted with respect to time.  $\bar{X}$  refers to the mean of the values within a given subgroup, while  $R$  is the range or greatest value minus least value. When approximately 20 or more  $\bar{X}$  and  $R$  values have been generated, the average of these values is computed as follows:

$$\bar{\bar{X}} = (\bar{X}_1 + \bar{X}_2 + \bar{X}_3 + \dots) / K$$

$$\bar{R} = (R_1 + R_2 + R_3 + \dots) / K$$

where  $K$  = the number of subgroups measured.

The values of  $\bar{\bar{X}}$  and  $\bar{R}$  are used to create the process control chart. Control charts are the primary SPC tool used to signal a problem. Shown in Figure 4, process control charts show  $\bar{X}$  and  $R$  values with respect to time and concerning reference to upper and lower control limit values. Control limits are computed as follows:

$$R \text{ upper control limit} = UCL_R = \bar{D}_4 \bar{R}$$

$$R \text{ lower control limit} = LCL_R = \bar{D}_3 \bar{R}$$

$$\bar{X} \text{ upper control limit} = UCL_{\bar{X}} = \bar{\bar{X}} + A_2 \bar{R}$$

$$\bar{X} \text{ lower control limit} = LCL_{\bar{X}} = \bar{\bar{X}} - A_2 \bar{R}$$

Where  $D_4$ ,  $D_3$  and  $A_2$  are constants varying by sample size, with values for sample sizes from 2 to 10 shown in the following partial table:

n	2	3	4	5	6	7	8	9	10
$D_4$	3.27	2.57	2.28	2.11	2.00	1.92	1.86	1.82	1.78
$D_3$	*	*	*	*	*	0.08	0.14	0.18	0.22
$A_2$	1.88	1.02	0.73	0.58	0.48	0.42	0.37	0.34	0.31

\* For sample sizes below 7, the  $LCL_R$  would technically be a negative number; in those cases there is no lower control limit; this means that for a subgroup size 6, six "identical" measurements would not be unreasonable.

Control charts are used to monitor the variability of critical process parameters. The  $R$  chart shows basic problems with piece to piece variability related to the process. The  $\bar{X}$  chart can often identify changes in people, machines, methods, etc. The source of the variability can be difficult to find and may require experimental design techniques to identify assignable causes.

Some general rules have been established to help determine when a process is **OUT-OF-CONTROL**. Figure 5a shows a control chart subdivided into zones A, B, and C corresponding to 3 sigma, 2 sigma, and 1 sigma limits respectively. In Figure 5b through Figure 5e four of the tests that can be used to identify excessive variability and the presence of assignable causes are shown. As familiarity with a given process increases, more subtle tests may be employed successfully.

Once the variability is identified, the cause of the variability must be determined. Normally, only a few factors have a significant impact on the total variability of the process. The importance of correctly identifying these factors is stressed in the following example. Suppose a process variability depends on the variance of five factors A, B, C, D and E. Each has a variance of 5, 3, 2, 1 and 0.4 respectively. Since:

$$\sigma_{tot} = \sqrt{\sigma_A^2 + \sigma_B^2 + \sigma_C^2 + \sigma_D^2 + \sigma_E^2}$$

$$\sigma_{tot} = \sqrt{5^2 + 3^2 + 2^2 + 1^2 + (0.4)^2} = 6.3$$

Now if only D is identified and eliminated then;

$$s_{tot} = \sqrt{5^2 + 3^2 + 2^2 + (0.4)^2} = 6.2$$

This results in less than 2% total variability improvement.

If B, C and D were eliminated, then;

$$\sigma_{tot} = \sqrt{5^2 + (0.4)^2} = 5.02$$

This gives a considerably better improvement of 23%. If only A is identified and reduced from 5 to 2, then;

$$\sigma_{tot} = \sqrt{2^2 + 3^2 + 2^2 + 1^2 + (0.4)^2} = 4.3$$

Identifying and improving the variability from 5 to 2 gives us a total variability improvement of nearly 40%.

Most techniques may be employed to identify the primary assignable cause(s). Out-of-control conditions may be correlated to documented process changes. The product may be analyzed in detail using best versus worst part comparisons or Product Analysis Lab equipment. Multi-variance analysis can be used to determine the family of variation (positional, critical or temporal). Lastly, experiments may be run to test theoretical or factorial analysis. Whatever method is used, assignable causes must

be identified and eliminated in the most expeditious manner possible.

After assignable causes have been eliminated, new control limits are calculated to provide a more challenging variability criteria for the process. As yields and variability improve, it may become more difficult to detect improvements because they become much smaller. When all assignable causes have been eliminated and the points remain within control limits for 25 groups, the process is said to be in a state of control.

### SUMMARY

Motorola is committed to the use of STATISTICAL PROCESS CONTROLS. These principles, used throughout manufacturing, have already resulted in many significant improvements to the processes. Continued dedication to the SPC culture will allow Motorola to reach the Six Sigma and zero defect capability goals. SPC will further enhance the commitment to **TOTAL CUSTOMER SATISFACTION.**

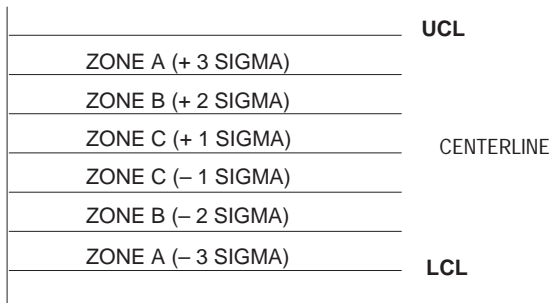


Figure 5a. Control Chart Zones

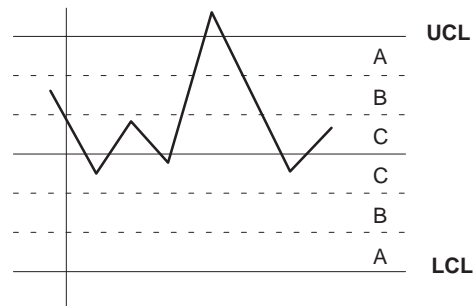


Figure 5b. One Point Outside Control Limit Indicating Excessive Variability

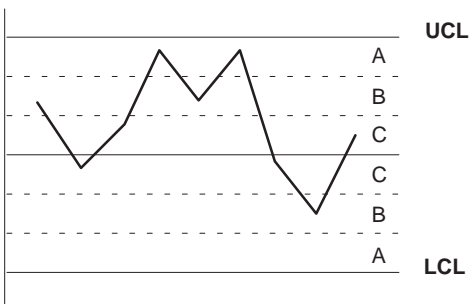


Figure 5c. Two Out of Three Points in Zone A or Beyond Indicating Excessive Variability

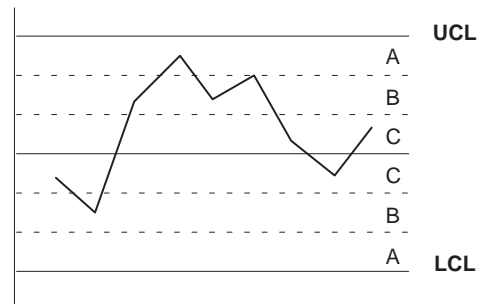


Figure 5d. Four Out of Five Points in Zone B or Beyond Indicating Excessive Variability

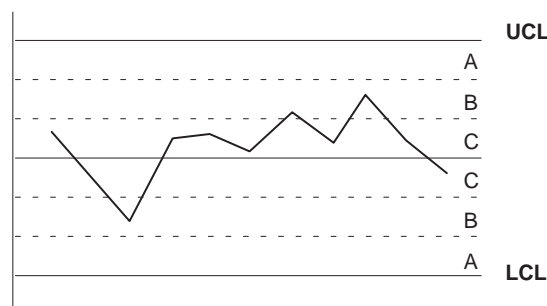


Figure 5e. Seven Out of Eight Points in Zone C or Beyond Indicating Excessive Variability

## RELIABILITY STRESS TESTS

The following gives brief descriptions of the reliability tests commonly used in the reliability monitoring program. Not all of the tests listed are performed on each product. Other tests may be performed when appropriate. In addition some form of preconditioning may be used in conjunction with the following tests.

### AUTOCLAVE (aka, PRESSURE COOKER)

Autoclave is an environmental test which measures device resistance to moisture penetration and the resultant effects of galvanic corrosion. Autoclave is a highly accelerated and destructive test.

**Typical Test Conditions:**  $T_A = 121^\circ\text{C}$ ,  $rh = 100\%$ ,  $p = 1$  atmosphere (15 psig),  $t = 24$  to 96 hours

**Common Failure Modes:** Parametric shifts, high leakage and/or catastrophic

**Common Failure Mechanisms:** Die corrosion or contaminants such as foreign material on or within the package materials. Poor package sealing

### HIGH HUMIDITY HIGH TEMPERATURE BIAS (H3TB or H3TRB)

This is an environmental test designed to measure the moisture resistance of plastic encapsulated devices. A bias is applied to create an electrolytic cell necessary to accelerate corrosion of the die metallization. With time, this is a catastrophically destructive test.

**Typical Test Conditions:**  $T_A = 85^\circ\text{C}$  to  $95^\circ\text{C}$ ,  $rh = 85\%$  to  $95\%$ , Bias = 80% to 100% of Data Book max. rating,  $t = 96$  to 1750 hours

**Common Failure Modes:** Parametric shifts, high leakage and/or catastrophic

**Common Failure Mechanisms:** Die corrosion or contaminants such as foreign material on or within the package materials. Poor package sealing

**Military Reference:** MIL-STD-750, Method 1042

### HIGH TEMPERATURE REVERSE BIAS (HTRB)

The purpose of this test is to align mobile ions by means of temperature and voltage stress to form a high-current leakage path between two or more junctions.

**Typical Test Conditions:**  $T_A = 85^\circ\text{C}$  to  $150^\circ\text{C}$ , Bias = 80% to 100% of Data Book max. rating,  $t = 120$  to 1000 hours

**Common Failure Modes:** Parametric shifts in leakage

**Common Failure Mechanisms:** Ionic contamination on the surface or under the metallization of the die

**Military Reference:** MIL-STD-750, Method 1039

### HIGH TEMPERATURE STORAGE LIFE (HTSL)

High temperature storage life testing is performed to accelerate failure mechanisms which are thermally activated through the application of extreme temperatures.

**Typical Test Conditions:**  $T_A = 70^\circ\text{C}$  to  $200^\circ\text{C}$ , no bias,  $t = 24$  to 2500 hours

**Common Failure Modes:** Parametric shifts in leakage

**Common Failure Mechanisms:** Bulk die and diffusion defects

**Military Reference:** MIL-STD-750, Method 1032

### INTERMITTENT OPERATING LIFE (IOL)

The purpose of this test is the same as SSOL in addition to checking the integrity of both wire and die bonds by means of thermal stressing.

**Typical Test Conditions:**  $T_A = 25^\circ\text{C}$ ,  $P_d =$  Data Book maximum rating,  $T_{\text{On}} = T_{\text{Off}} = \Delta$  of  $50^\circ\text{C}$  to  $100^\circ\text{C}$ ,  $t = 42$  to 30000 cycles

**Common Failure Modes:** Parametric shifts and catastrophic

**Common Failure Mechanisms:** Foreign material, crack and bulk die defects, metallization, wire and die bond defects

**Military Reference:** MIL-STD-750, Method 1037

### MECHANICAL SHOCK

This test is used to determine the ability of the device to withstand a sudden change in mechanical stress due to abrupt changes in motion as seen in handling, transportation, or actual use.

**Typical Test Conditions:** Acceleration = 1500 g's, Orientation =  $X_1, Y_1, Y_2$  plane,  $t = 0.5$  msec, Blows = 5

**Common Failure Modes:** Open, short, excessive leakage, mechanical failure

**Common Failure Mechanisms:** Die and wire bonds, cracked die, package defects

**Military Reference:** MIL-STD-750, Method 2015

### MOISTURE RESISTANCE

The purpose of this test is to evaluate the moisture resistance of components under temperature/humidity conditions typical of tropical environments.

**Typical Test Conditions:**  $T_A = -10^\circ\text{C}$  to  $65^\circ\text{C}$ ,  $rh = 80\%$  to  $98\%$ ,  $t = 24$  hours/cycle, cycle = 10

**Common Failure Modes:** Parametric shifts in leakage and mechanical failure

**Common Failure Mechanisms:** Corrosion or contaminants on or within the package materials. Poor package sealing

**Military Reference:** MIL-STD-750, Method 1021

### SOLDERABILITY

The purpose of this test is to measure the ability of device leads/terminals to be soldered after an extended period of storage (shelf life).

**Typical Test Conditions:** Steam aging = 8 hours, Flux = R, Solder = Sn60, Sn63

**Common Failure Modes:** Pin holes, dewetting, non-wetting

**Common Failure Mechanisms:** Poor plating, contaminated leads

**Military Reference:** MIL-STD-750, Method 2026



**SOLDER HEAT**

This test is used to measure the ability of a device to withstand the temperatures as may be seen in wave soldering operations. Electrical testing is the endpoint criterion for this stress.

**Typical Test Conditions:** Solder Temperature = 260°C, t = 10 seconds

**Common Failure Modes:** Parameter shifts, mechanical failure

**Common Failure Mechanisms:** Poor package design

**Military Reference:** MIL-STD-750, Method 2031

**STEADY STATE OPERATING LIFE (SSOL)**

The purpose of this test is to evaluate the bulk stability of the die and to generate defects resulting from manufacturing aberrations that are manifested as time and stress-dependent failures.

**Typical Test Conditions:**  $T_A = 25^\circ\text{C}$ ,  $P_D =$  Data Book maximum rating, t = 16 to 1000 hours

**Common Failure Modes:** Parametric shifts and catastrophic

**Common Failure Mechanisms:** Foreign material, crack die, bulk die, metallization, wire and die bond defects

**Military Reference:** MIL-STD-750, Method 1026

**TEMPERATURE CYCLING (AIR TO AIR)**

The purpose of this test is to evaluate the ability of the device to withstand both exposure to extreme temperatures and transitions between temperature extremes. This testing will also expose excessive thermal mismatch between materials.

**Typical Test Conditions:**  $T_A = -65^\circ\text{C}$  to  $200^\circ\text{C}$ , cycle = 10 to 1000

**Common Failure Modes:** Parametric shifts and catastrophic

**Common Failure Mechanisms:** Wire bond, cracked or lifted die and package failure

**Military Reference:** MIL-STD-750, Method 1051

**THERMAL SHOCK (LIQUID TO LIQUID)**

The purpose of this test is to evaluate the ability of the device to withstand both exposure to extreme temperatures and sudden transitions between temperature extremes. This testing will also expose excessive thermal mismatch between materials.

**Typical Test Conditions:**  $T_A = 0^\circ\text{C}$  to  $100^\circ\text{C}$ , cycles = 10 to 1000

**Common Failure Modes:** Parametric shifts and catastrophic

**Common Failure Mechanisms:** Wire bond, cracked or lifted die and package failure

**Military Reference:** MIL-STD-750, Method 1056

**VARIABLE FREQUENCY VIBRATION**

This test is used to examine the ability of the device to withstand deterioration due to mechanical resonance.

**Typical Test Conditions:** Peak acceleration = 20 g's, Frequency range = 20 Hz to 20 kHz, t = 48 minutes.

**Common Failure Modes:** Open, short, excessive leakage, mechanical failure

**Common Failure Mechanisms:** Die and wire bonds, cracked die, package defects

**Military Reference:** MIL-STD-750, Method 2056

# Chapter 4

## ZENER DIODE CHARACTERISTICS

### INTRODUCTION

At first glance the zener diode is a simple device consisting of one P-N junction with controlled breakdown voltage properties. However, when considerations are given to the variations of temperature coefficient, zener impedance, thermal time response, and capacitance, all of which are a function of the breakdown voltage (from 1.8 to 400 V), a much more complicated picture arises. In addition to the voltage spectrum, a variety of power packages are on the market with a variation of dice area inside the encapsulation.

This chapter is devoted to sorting out the important considerations in a "typical" fashion. For exact details, the data sheets must be consulted. However, much of the information contained herein is supplemental to the data sheet curves and will broaden your understanding of zener diode behavior.

Specifically, the following main subjects will be detailed:

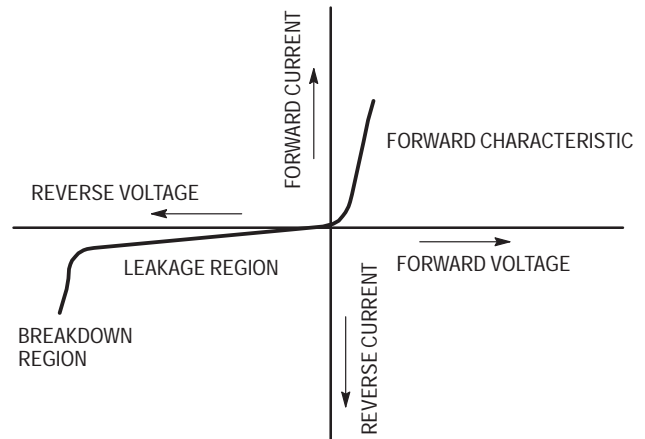
- Basic DC Volt-Ampere Characteristics
- Impedance versus Voltage and Current
- Temperature Coefficient versus Voltage and Current
- Power Derating
- Mounting
- Thermal Time Response — Effective Thermal Impedance
- Surge Capabilities
- Frequency Response — Capacitance and Switching Effects

### BASIC ZENER DIODE DC VOLT-AMPERE CHARACTERISTICS

Reverse and forward volt-ampere curves are represented in Figure 1 for a typical zener diode. The three areas — forward, leakage, and breakdown — will each be examined.

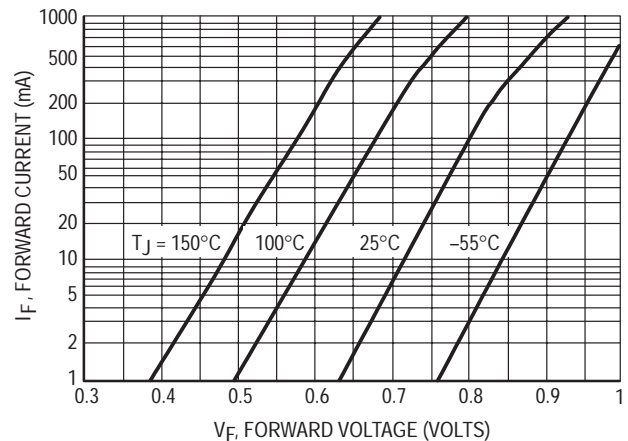
### FORWARD DC CHARACTERISTICS

The forward characteristics of a zener diode are essentially identical with an "ordinary" rectifier and is shown in Figure 2. The volt-ampere curve follows the basic diode equation of  $I_F = I_R e^{qV_F/KT}$  where  $KT/q$  equals about 0.026 volts at room temperature and  $I_R$  (reverse leakage current) is dependent upon the doping levels of the P-N junction as well as the area. The actual plot of  $V_F$  versus  $I_F$  deviates from the theoretical due to slightly "fixed" series resistance of the lead wire, bonding contacts and some bulk effects in the silicon.



**Figure 1. Typical Zener Diode DC V-I Characteristics (Not to Scale)**

While the common form of the diode equation suggests that  $I_R$  is constant, in fact  $I_R$  is itself strongly temperature dependent. The rapid increase in  $I_R$  with increasing temperature dominates the decrease contributed by the exponential term in the diode equation. As a result, the forward current increases with increasing temperature. Figure 2 shows a forward characteristic temperature dependence for a typical zener. These curves indicate that for a constant current, an increase in temperature causes a decrease in forward voltage. The voltage temperature coefficient values are typically in the range of  $-1.4$  to  $-2$  mV/°C.



**Figure 2. Typical Forward Characteristics of Zener Diodes**

## LEAKAGE DC CHARACTERISTICS

When reverse voltage less than the breakdown is applied to a zener diode, the behavior of current is similar to any back-biased silicon P-N junction. Ideally, the reverse current would reach a level at about one volt reverse voltage and remain constant until breakdown is reached. There are both theoretical and practical reasons why the typical V-I curve will have a definite slope to it as seen in Figure 3. Multiplication effects and charge generation sites are present in a zener diode which dictate that reverse current (even at low voltages) will increase with voltage. In addition, surface charges are ever present across P-N junctions which appear to be resistive in nature.

The leakage currents are generally less than one microampere at 150°C except with some large area devices. Quite often a leakage specification at 80% or so of breakdown voltage is used to assure low reverse currents.

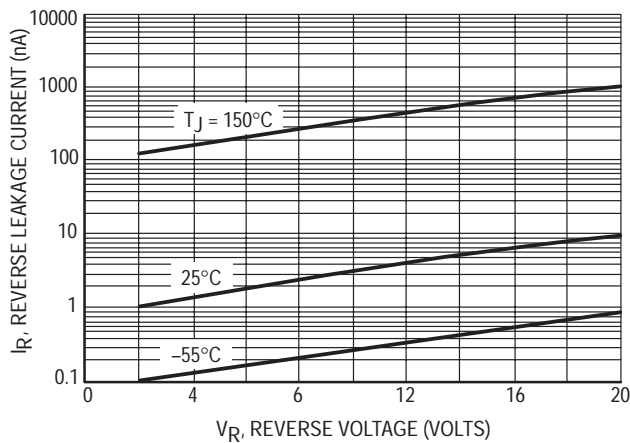


Figure 3. Typical Leakage Current versus Voltage

## VOLTAGE BREAKDOWN

At some definite reverse voltage, depending on the doping levels (resistivity) of the P-N junction, the current will begin to avalanche. This is the so-called “zener” or “breakdown” area and is where the device is usually biased during use. A typical family of breakdown curves showing the effect of temperature is illustrated in Figure 4.

Between the minimum currents shown in Figure 4 and the leakage currents, there is the “knee” region. The avalanche mechanism may not occur simultaneously across the entire area of the P-N junction, but first at one microscopic site, then at an increasing number of sites as further voltage is applied. This action can be accounted for by the “microplasma discharge” theory and correlates with several breakdown characteristics.

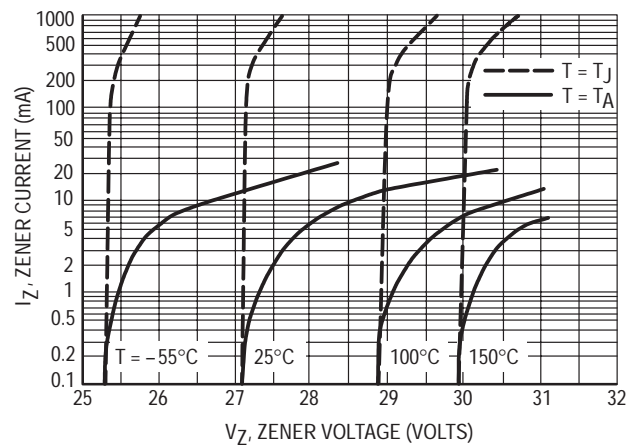


Figure 4. Typical Zener Characteristic Variation with Temperature

An exaggerated view of the knee region is shown in Figure 5. As can be seen, the breakdown or avalanche current does not increase suddenly, but consists of a series of smoothly rising current versus voltage increments each with a sudden break point.

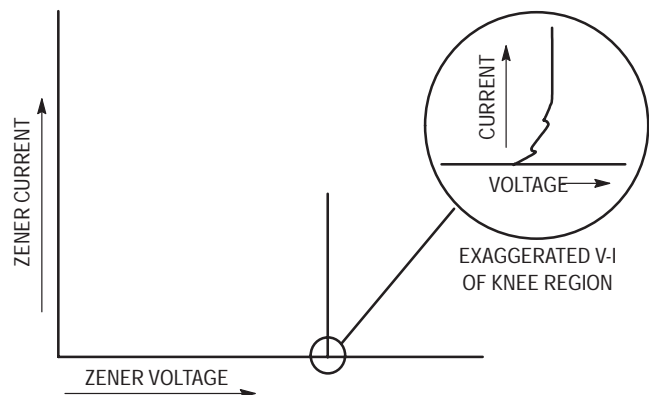


Figure 5. Exaggerated V-I Characteristics of the Knee Region

At the lowest point, the zener resistance (slope of the curve) would test high, but as current continues to climb, the resistance decreases. It is as though each discharge site has high resistance with each succeeding site being in parallel until the total resistance is very small.

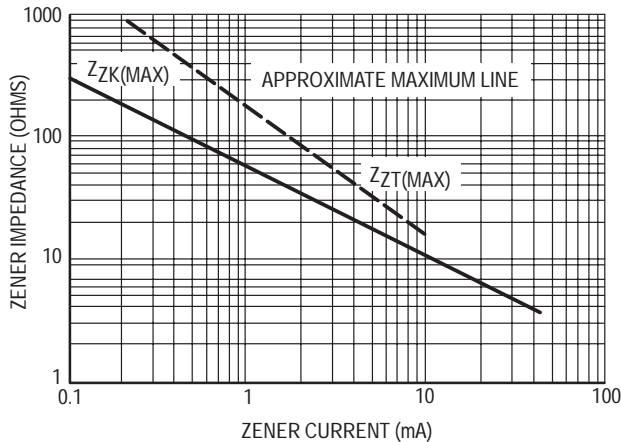
In addition to the resistive effects, the micro plasmas may act as noise generators. The exact process of manufacturing affects how high the noise will be, but in any event there will be some noise at the knee, and it will diminish considerably as current is allowed to increase.

Since the zener impedance and the temperature coefficient are of prime importance when using the zener diode as a reference device, the next two sections will expand on these points.

**ZENER IMPEDANCE**

The slope of the  $V_Z - I_Z$  curve (in breakdown) is defined as zener impedance or resistance. The measurement is generally done with a 60 Hz (on modern, computerized equipment this test is being done at 1 kHz) current variation whose value is 10% in rms of the dc value of the current. (That is,  $\Delta I_Z$  peak to peak = 0.282  $I_Z$ .) This is really not a small signal measurement but is convenient to use and gives repeatable results.

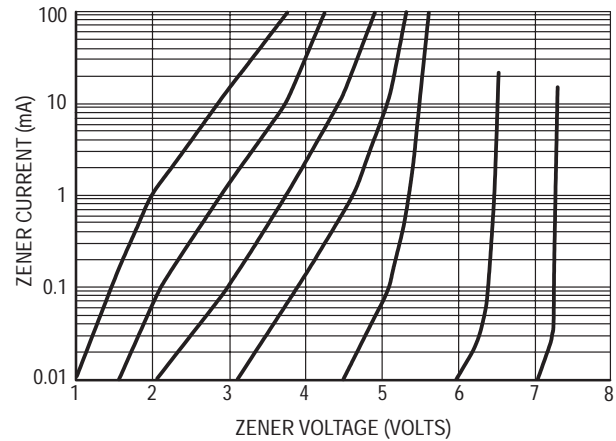
The zener impedance always decreases as current increases, although at very high currents (usually beyond  $I_Z$  max) the impedance will approach a constant. In contrast, the zener impedance decreases very rapidly with increasing current in the knee region. Motorola specifies most zener diode impedances at two points:  $I_{ZT}$  and  $I_{ZK}$ . The term  $I_{ZT}$  usually is at the quarter power point, and  $I_{ZK}$  is an arbitrary low value in the knee region. Between these two points a plot of impedance versus current on a log-log scale is close to a straight line. Figure 6 shows a typical plot of  $Z_Z$  versus  $I_Z$  for a 20 volt–500 mW zener. The worst case impedance between  $I_{ZT}$  and  $I_{ZK}$  could be approximated by assuming a straight line function on a log-log plot; however, at currents above  $I_{ZT}$  or below  $I_{ZK}$  a projection of this line may give erroneous values.



**Figure 6. Zener Impedance versus Zener Current**

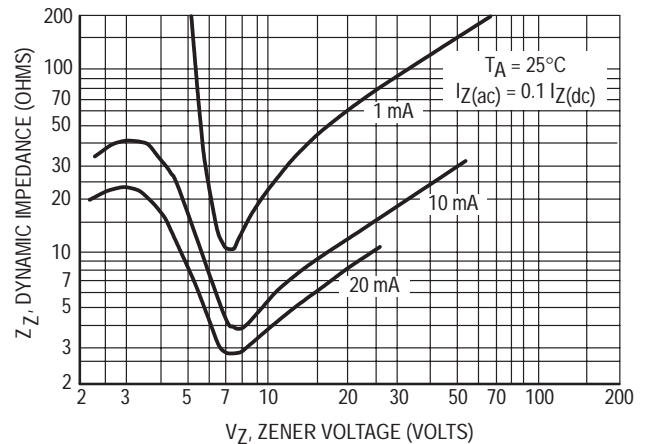
The impedance variation with voltage is much more complex. First of all, zeners below 6 volts or so exhibit “field emission” breakdown converting to “avalanche” at higher currents. The two breakdowns behave somewhat differently with “field emission” associated with high impedance and negative temperature coefficients and “avalanche” with lower impedance and positive temperature coefficients.

A V-I plot of several low voltage 500 mW zener diodes is shown in Figure 7. It is seen that at some given current (higher for the lower voltage types) there is a fairly sudden decrease in the slope of  $\Delta V/\Delta I$ . Apparently, this current is the transition from one type of breakdown to the other. Above 6 volts the curves would show a gradual decrease of  $\Delta V/\Delta I$  rather than an abrupt change, as current is increased.



**Figure 7. Zener Current versus Zener Voltage (Low Voltage Region)**

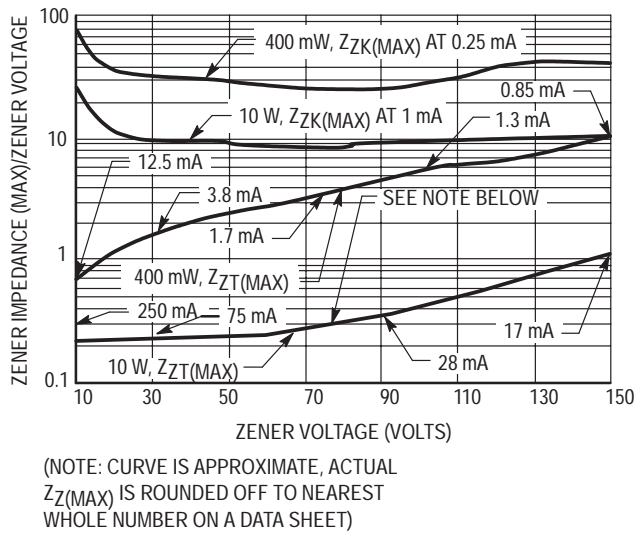
Possibly the plots shown in Figure 8 of zener impedance versus voltage at several constant  $I_Z$ 's more clearly points out this effect. It is obvious that zener diodes whose breakdowns are about 7 volts will have remarkably low impedance.



**Figure 8. Dynamic Zener Impedance (Typical) versus Zener Voltage**

However, this is not the whole picture. A zener diode figure of merit as a regulator could be  $Z_Z/V_Z$ . This would give some idea of what percentage change of voltage could be expected for some given change in current. Of course, a low  $Z_Z/V_Z$  is desirable. Generally zener current must be decreased as voltage is increased to prevent excessive power dissipation; hence zener impedance will rise even higher and the “figure of merit” will become higher as voltage increases. This is the case with  $I_{ZT}$  taken as the test point. However, if  $I_{ZK}$  is used as a comparison level in those devices which keep a constant  $I_{ZK}$  over a large range of voltage, the “figure of merit” will exhibit a bowl-shaped curve — first decreasing and then increasing as voltage is increased. Typical plots are shown in Figure 9. The conclusion can be reached that for uses where wide swings of current may occur and the quiescent bias current must be high, the lower voltage zener will provide best regulation,

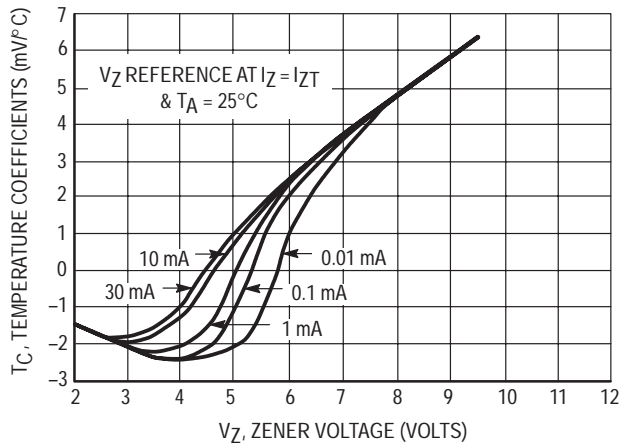
but for low power applications, the best performance could be obtained between 50 and 100 volts.



**Figure 9. Figure of Merit:  $Z_Z(MAX)/V_Z$  versus  $V_Z$  (400 mW & 10 W Zeners)**

**TEMPERATURE COEFFICIENT**

Below three volts and above eight volts the zener voltage change due to temperature is nearly a straight line function and is almost independent of current (disregarding self-heating effects). However, between three and eight volts the temperature coefficients are not a simple affair. A typical plot of  $T_C$  versus  $V_Z$  is shown in Figure 10.

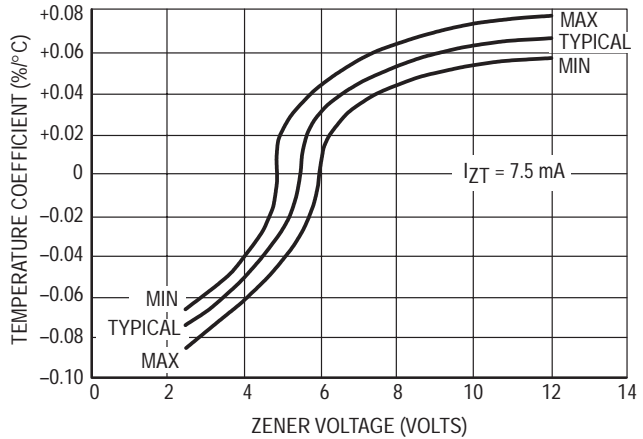


**Figure 10. Temperature Coefficient versus Zener Voltage at 25°C Conditions Typical**

Any attempt to predict voltage changes as temperature changes would be very difficult on a "typical" basis. (This, of course, is true to a lesser degree below three volts and above eight volts since the curve shown is a typical one and slight deviations will exist with a particular zener diode.) For example, a zener which is 5 volts at 25°C could be from 4.9 to 5.05 volts at 75°C depending on the current level. Whereas, a zener which is 9 volts at 25°C would be close

to 9.3 volts at 75°C for all useful current levels (disregarding impedance effects).

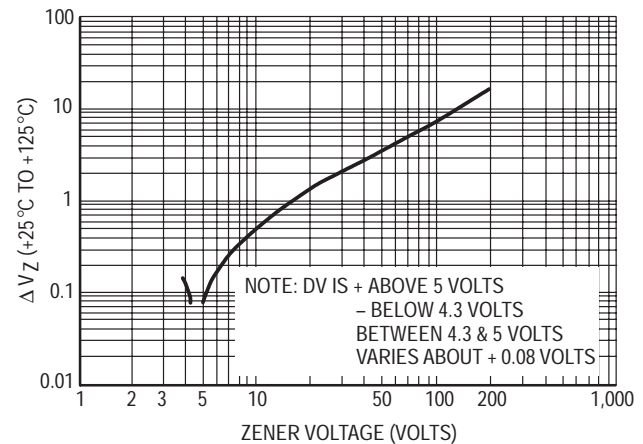
As was mentioned, the situation is further complicated by the normal deviation of  $T_C$  at a given current. For example, for 7.5 mA the normal spread of  $T_C$  (expressed in %/°C) is shown in Figure 11. This is based on limited samples and in no manner implies that all Motorola zeners between 2 and 12 volts will exhibit this behavior. At other current levels similar deviations would occur.



**Figure 11. Temperature Coefficient Spread versus Zener Voltage**

Obviously, all of these factors make it very difficult to attempt any calculation of precise voltage shift due to temperature. Except in devices with specified maximum T.C., no "worse case" design is possible. Information concerning the Motorola temperature compensated or reference diodes is given in Chapter 5.

Typical temperature characteristics for a broad range of voltages is illustrated in Figure 12. This graphically shows the significant change in voltage for high voltage devices (about a 20 volt increase for a 100°C increase on a 200 volt device).



**Figure 12. Typical Temperature Characteristics**

**POWER DERATING AND MOUNTING**

The zener diode like any other semiconductor has a maximum junction temperature. This limit is somewhat arbitrary and is set from a reliability viewpoint. Most semiconductors exhibit an increasing failure rate as temperature increases. At some temperature, the solder will melt or soften and the failure rate soars. The 175°C to 200°C junction temperature rating is quite safe from solder failures and still has a very low failure rate.

In order that power dissipated in the device will never cause the junction to rise beyond 175°C or 200°C (depending on the device), the relation between temperature rise and power must be known. Of course, the thermal resistance ( $R_{\theta JA}$  or  $R_{\theta JL}$ ) is the factor which relates power and temperature in the well known "Thermal Ohm's Law" relation:

$$\Delta T = T_J - T_A = R_{\theta JA} P_Z \tag{1}$$

and

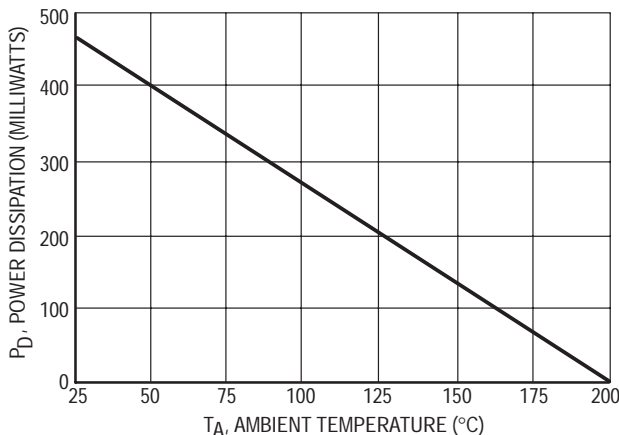
$$\Delta T = T_J - T_L = R_{\theta JL} P_Z \tag{2}$$

where

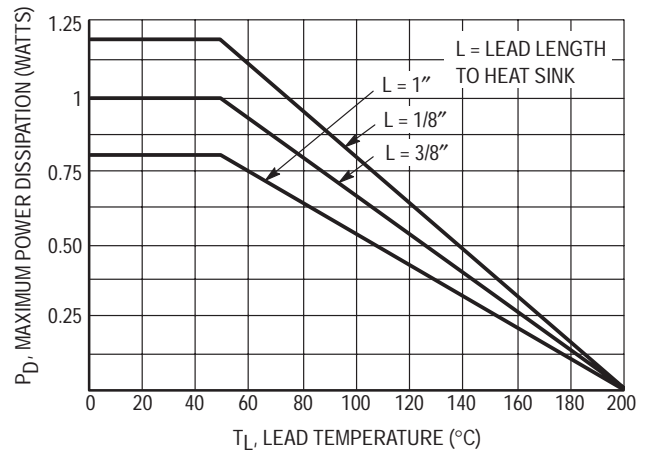
- $T_J$  = Junction temperature
- $T_A$  = Ambient temperature
- $T_L$  = Lead temperature
- $R_{\theta JA}$  = Thermal resistance junction to ambient
- $R_{\theta JL}$  = Thermal resistance junction to lead
- $P_Z$  = Zener power dissipation

Obviously, if ambient or lead temperature is known and the appropriate thermal resistance for a given device is known, the junction temperature could be precisely calculated by simply measuring the zener dc current and voltage ( $P_Z = I_Z V_Z$ ). This would be helpful to calculate voltage change versus temperature. However, only maximum and typical values of thermal resistance are given for a family of zener diodes. So only "worst case" or typical information could be obtained as to voltage changes.

The relations of equations 1 and 2 are usually expressed as a graphical derating of power versus the appropriate temperature. Maximum thermal resistance is used to generate the slope of the curve. An example of a 400 milliwatt device derated to the ambient temperature and a 1 watt device derated to the lead temperature are shown in Figures 13 and 14.



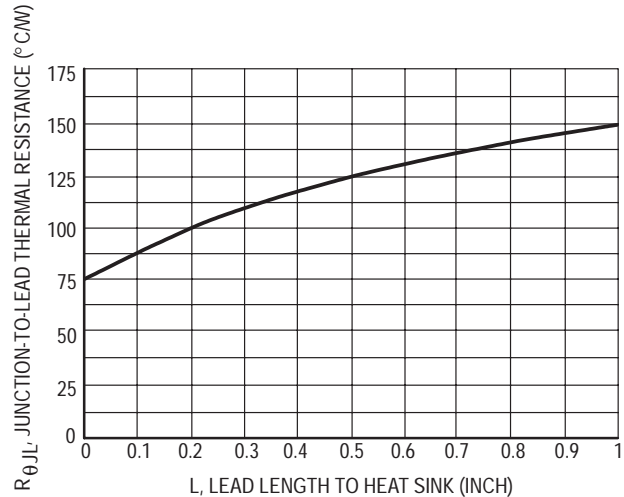
**Figure 13. 400 mW Power Temperature Derating Curve**



**Figure 14. Power Temperature Derating Curve**

A lead mounted device can have its power rating increased by shortening the lead length and "heatsinking" the ends of the leads. This effect is shown in Figure 15, for the 1N4728, 1 watt zener diode.

Each zener has a derating curve on its data sheet and steady state power can be set properly. However, temperature increases due to pulse use are not so easily calculated. The use of "Transient Thermal Resistance" would be required. The next section expounds upon transient thermal behavior as a function of time and surge power.



**Figure 15. Typical 1N4728 Thermal Resistance versus Lead Length**

**THERMAL TIME RESPONSE**

Early studies of zener diodes indicated that a "thermal time constant" existed which allowed calculation of temperature rise as a function of power pulse height, width, and duty cycle. More precise measurements have shown that temperature response as a function of time cannot be represented as a simple time constant. Although as shown in the preceding section, the steady state conditions are analogous in every way to an electrical resistance; a simple "thermal capacitance" placed across the resistor is not the true equivalent circuit. Probably a series of parallel R-C

networks or lumped constants representing a thermal transmission line would be more accurate.

Fortunately a concept has developed in the industry wherein the exact thermal equivalent circuit need not be found. If one simply accepts the concept of a thermal resistance which varies with time in a predictable manner, the situation becomes very practical. For each family of zener diodes, a "worst case" transient thermal resistance curve may be generated.

The main use of this transient  $R_{\theta JL}$  curve is when the zener is used as a clipper or a protective device. First of all, the power wave shape must be constructed. (Note, even though the power-transient thermal resistance indicates reasonable junction temperatures, the device still may fail if the peak current exceeds certain values. Apparently a current crowding effect occurs which causes the zener to short. This is discussed further in this section.)

**TRANSIENT POWER-TEMPERATURE EFFECTS**

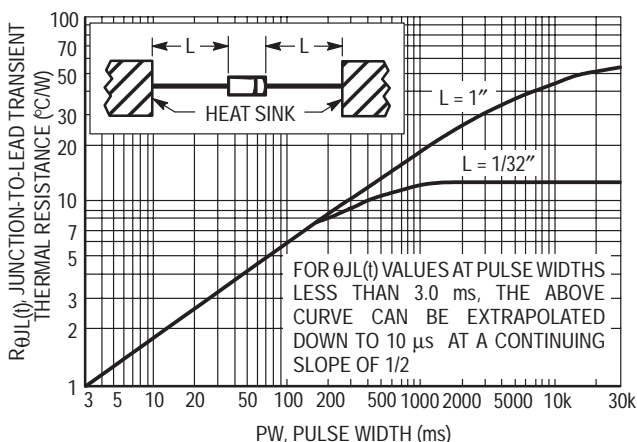
A typical transient thermal resistance curve is shown in Figure 16. This is for a lead mounted device and shows the effect of lead length to an essentially infinite heatsink.

To calculate the temperature rise, the power surge wave shape must be approximated by its rectangular equivalent as shown in Figure 17. In case of an essentially non-recurrent pulse, there would be just one pulse, and  $\Delta T = R_{\theta T1} P_p$ . In the general case, it can be shown that

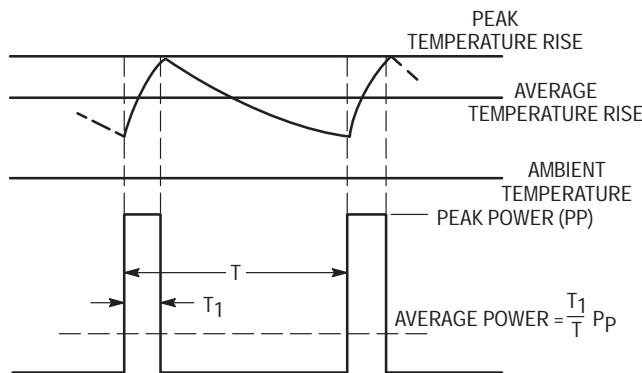
$$\Delta T = [DR_{\theta JA} (ss) + (1 - D) R_{\theta T1} + T + R_{\theta T1} - R_{\theta T}] P_p$$

where

- D = Duty cycle in percent
- $R_{\theta T1}$  = Transient thermal resistance at the time equal to the pulse width
- $R_{\theta T}$  = Transient thermal resistance at the time equal to pulse interval
- $R_{\theta T1} + T$  = Transient thermal resistance at the time equal to the pulse interval plus one more pulse width.
- $R_{\theta JA}(ss)$  or  $R_{\theta JL}(ss)$  = Steady state value of thermal resistance



**Figure 16. Typical Transient Thermal Resistance (For Axial Lead Zener)**



**Figure 17. Relation of Junction Temperature to Power Pulses**

This method will predict the temperature rise at the end of the power pulse after the chain of pulses has reached equilibrium. In other words, the average power will have caused an average temperature rise which has stabilized, but a temperature "ripple" is present.

Example: (Use curve in Figure 16)

- $P_p = 5$  watt (Lead length 1/32")
- $D = 0.1$
- $T_1 = 10$  ms
- $T = 100$  ms
- $R_{\theta JA}(ss) = 12^\circ C/W$  (for 1/32" lead length)

Then

- $R_{\theta T1} = 1.8^\circ C/W$
- $R_{\theta T} = 5.8^\circ C/W$
- $R_{\theta T1} + T = 6^\circ C/W$

And

$$\Delta T = [0.1 \times 12 + (1 - 0.1) 6 + 1.8 - 5.8] 5$$

$$\Delta T = 13^\circ C$$

Or at  $T_A = 25^\circ$ ,  $T_J = 38^\circ C$  peak

**SURGE FAILURES**

If no other considerations were present, it would be a simple matter to specify a maximum junction temperature no matter what pulses are present. However, as has been noted, apparently other fault conditions prevail. The same group of devices for which the transient thermal curves were generated were tested by subjecting them to single shot power pulses. A failure was defined as a significant shift of leakage or zener voltage, or of course opens or shorts. Each device was measured before and after the applied pulse. Most failures were shifts in zener voltage. The results are shown in Figure 18.

Attempts to correlate this to the transient thermal resistance work quite well on a typical basis. For example, assuming a value for 1 ms of 90 watts and 35 watts at 10 ms, the predicted temperature rise would be 180°C and 190°C. But on a worst case basis, the temperature rises would be about one half these values or junction temperatures, on the order of 85°C to 105°C, which are obviously low. Apparently at very high power levels a current restriction occurs causing hot spots. There was no apparent correlation of zener voltage or current on the failure points since each group of failures contained a mixture of voltages.

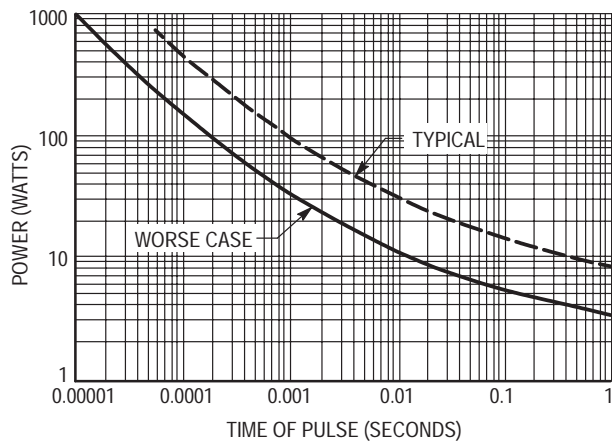


Figure 18. One Shot Power Failure Axial Lead Zener Diode

### VOLTAGE VERSUS TIME

Quite often the junction temperature is only of academic interest, and the designer is more concerned with the voltage behavior versus time. By using the transient thermal resistance, the power, and the temperature coefficient, the designer could generate  $V_Z$  versus time curves. The Motorola zener diode test group has observed device voltages versus time until the thermal equilibrium was reached. A typical curve is shown for a lead mounted low wattage device in Figure 19 where the ambient temperature was maintained constant. It is seen that voltage stabilizes in about 100 seconds for 1 inch leads.

Since information contained in this section may not be found on data sheets it is necessary for the designer to contact the factory when using a zener diode as a surge suppressor. Additional information on transient suppression application is presented elsewhere in this book.

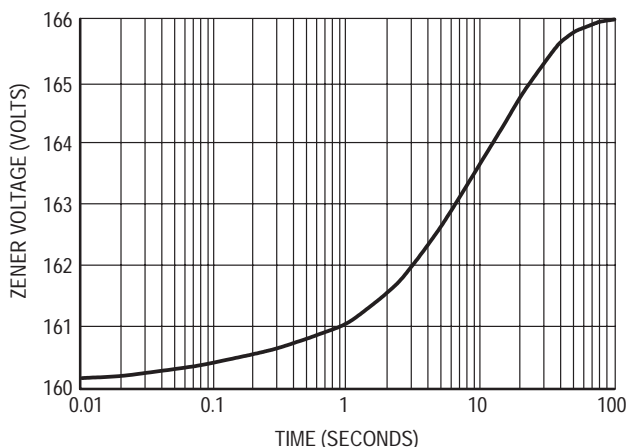


Figure 19. Zener Voltage (Typical) versus Time for Step Power Pulses (500 mW Lead Mounted Devices)

### FREQUENCY AND PULSE CHARACTERISTICS

The zener diode may be used in applications which require a knowledge of the frequency response of the device. Of main concern are the zener resistance (usually specified as "impedance") and the junction capacitance. The capacitance curves shown in this section are typical.

### ZENER CAPACITANCE

Since zener diodes are basically PN junctions operated in the reverse direction, they display a capacitance that decreases with increasing reverse voltage. This is so because the effective width of the PN junction is increased by the removal of charges (holes and electrons) as reverse voltage is increased. This decrease in capacitance continues until the zener breakdown region is entered; very little further capacitance change takes place, owing to the now fixed voltage across the junction. The value of this capacitance is a function of the material resistivity,  $\rho$ , (amount of doping — which determines  $V_Z$  nominal), the diameter,  $D$ , of junction or dice size (determines amount of power dissipation), the voltage across the junction  $V_C$ , and some constant,  $K$ . This relationship can be expressed as:

$$C_C = n \sqrt{\frac{KD^4}{\rho V_C}}$$

After the junction enters the zener region, capacitance remains relatively fixed and the AC resistance then decreases with increasing zener current.

**TEST CIRCUIT CONSIDERATIONS:** A capacitive bridge was used to measure junction capacitance. In this method the zener is used as one leg of a bridge that is balanced for both DC at a given reverse voltage and for AC (the test frequency 1 MHz). After balancing, the variable capacitor used for balancing is removed and its value measured on a test instrument. The value thus indicated is the zener capacitance at reverse voltage for which bridge balance was obtained. Figure 20 shows capacitance test circuit.

Figure 21 is a plot of junction capacitance for diffused zener diode units versus their nominal operating voltage. Capacitance is the value obtained with reverse bias set at one-half the nominal  $V_Z$ . The plot of the voltage range from 6.8 V to 200 V, for three dice sizes, covers most Motorola diffused-junction zeners. Consult specific data sheets for capacitance values.

Figures 22, 23, and 24 show plots of capacitance versus reverse voltage for units of various voltage ratings in each of the three dice sizes. Junction capacitance decreases as reverse voltage increases to the zener region. This change in capacitance can be expressed as a ratio which follows a one-third law, and  $C_1/C_2 = (V_2/V_1)^{1/3}$ . This law holds only from the zener voltage down to about 1 volt, where the curve begins to flatten out. Figure 25 shows this for a group of low wattage units.



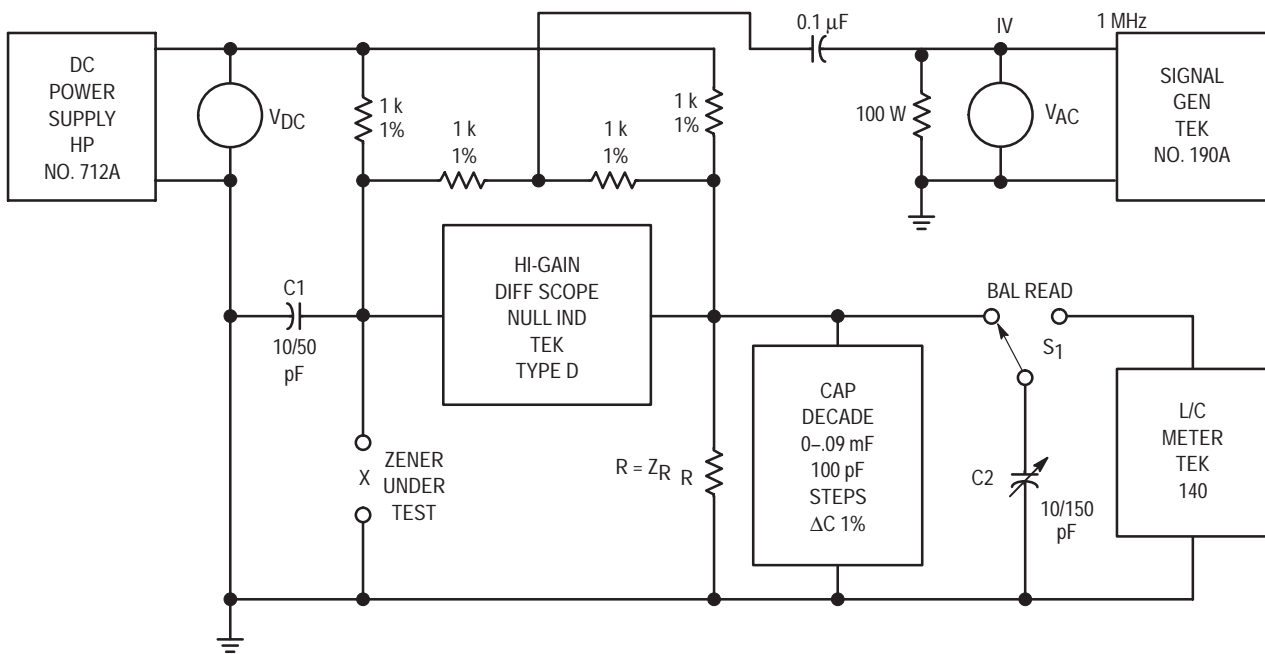


Figure 20. Capacitance Test Circuit

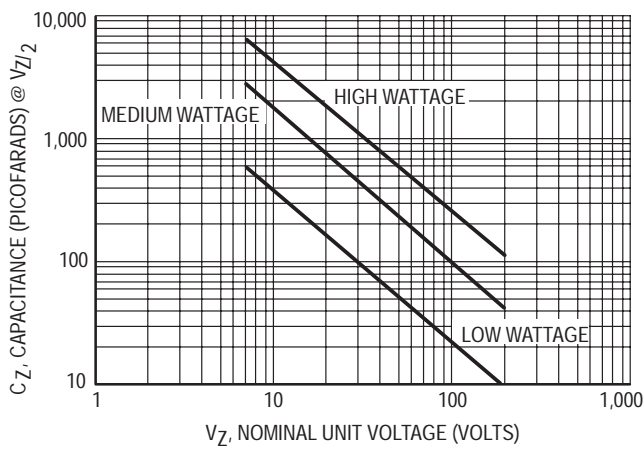


Figure 21. Capacitance versus Voltage

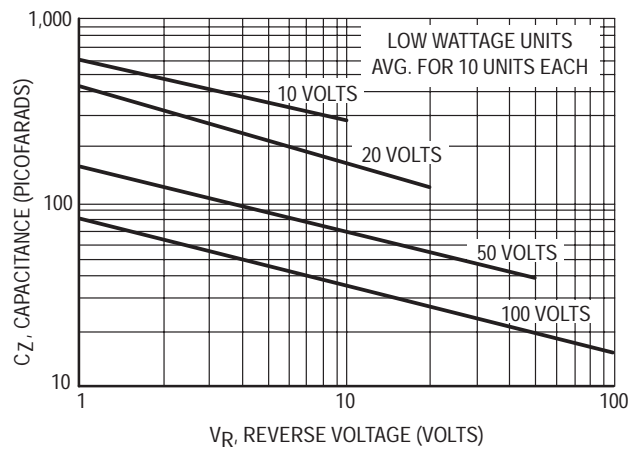


Figure 22. Capacitance versus Reverse Voltage

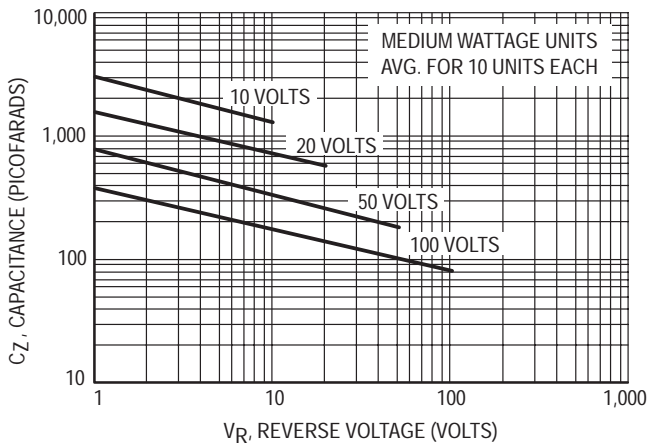


Figure 23. Capacitance versus Reverse Voltage

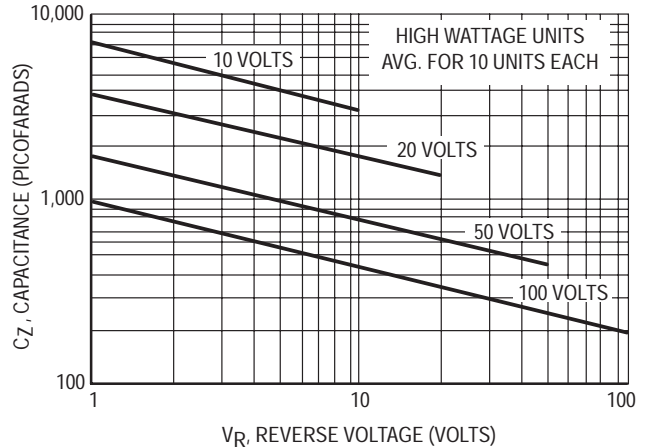


Figure 24. Capacitance versus Reverse Voltage

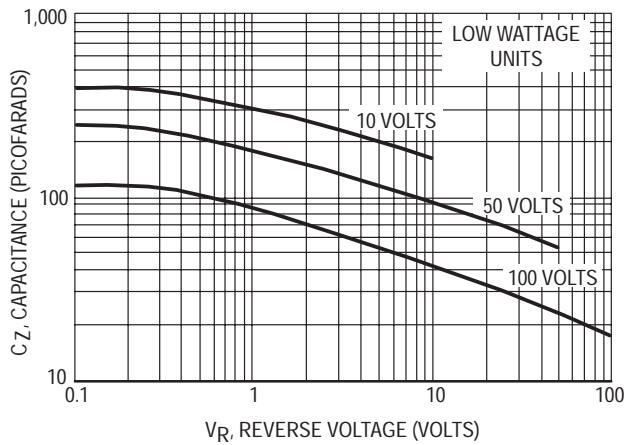


Figure 25. Flattening of Capacitance Curve at Low Voltages

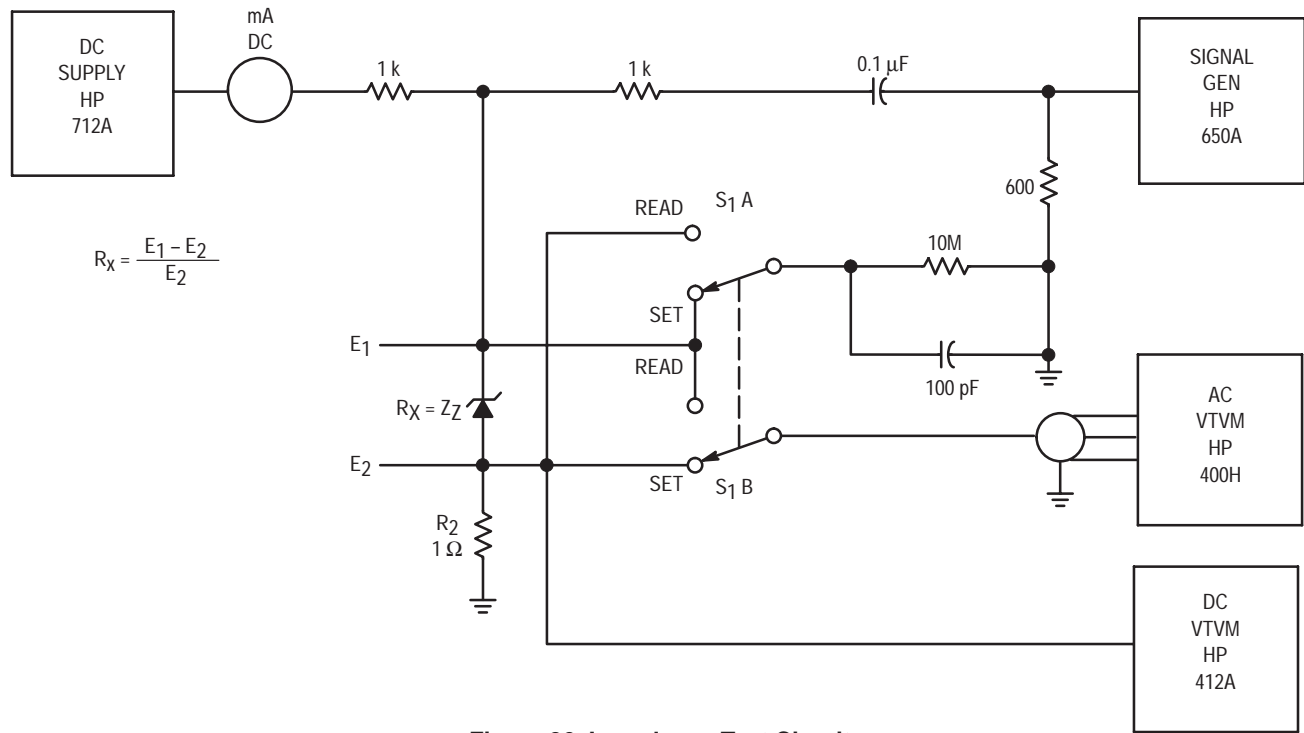


Figure 26. Impedance Test Circuit

**ZENER IMPEDANCE**

Zener impedance appears primarily as composed of a current-dependent resistance shunted by a voltage-dependent capacitor. Figure 26 shows the test circuit used to gather impedance data. This is a voltage-impedance ratio method of determining the unknown zener impedance. The operation is as follows:

- (1) Adjust for desired zener  $I_{ZDC}$  by observing IR drop across the 1-ohm current-viewing resistor  $R_2$ .
- (2) Adjust  $I_{ZAC}$  to 100  $\mu A$  by observing AC IR drop across  $R_2$ .
- (3) Measure the voltage across the entire network by switching  $S_1$ . The ratio of these two AC voltages is then

a measure of the impedance ratio. This can be expressed simply as  $R_X = [(E_1 - E_2)/E_2] R_2$ .

Section A of  $S_1$  provides a dummy load consisting of a 10-M resistor and a 100 pF capacitor. This network is required to simulate the input impedance of the AC VTVM while it is being used to measure the AC IR drop across  $R_2$ .

This method has been found accurate up to about three megahertz; above this frequency, lead inductances and strap capacitance become the dominant factors.

Figure 27 shows typical impedance versus frequency relationships of 6.8 volt 500 mW zener diodes at various DC zener currents. Before the zener breakdown region is entered, the impedance is almost all reactive, being provided by a voltage-dependent capacitor shunted by a very high resistance. When the zener breakdown region is entered,

the capacitance is fixed and now is shunted by current-dependent resistance. For comparison, Figure 27 also shows the plot for a 680 pF capacitor  $X_C$ , a 1K 1% nonreactive resistor, R, and the parallel combination of these two passive elements,  $Z_T$ .

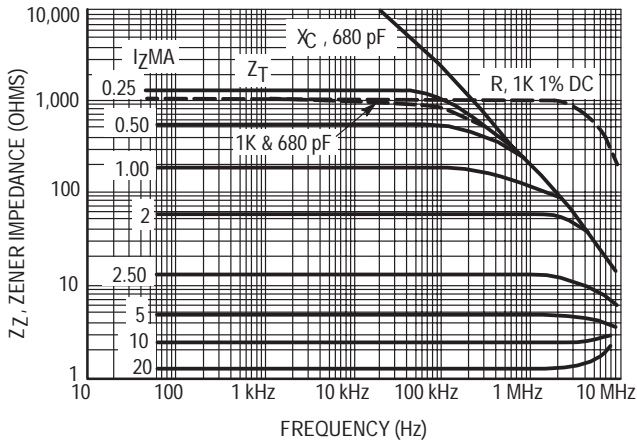


Figure 27. Zener Impedance versus Frequency

### HIGH FREQUENCY AND SWITCHING CONSIDERATIONS

At frequencies about 100 kHz or so and switching speeds above 10 microseconds, shunt capacitance of zener diodes begins to seriously effect their usefulness. The upper photo of Figure 28 shows the output waveform of a symmetrical peak limiter using two zener diodes back-to-back. The capacitive effects are obvious here. In any application where the signal is recurrent, the shunt capacitance limitations can be overcome, as lower photo of Figure 28 shows. This is done by operating fast diodes in series with the zener. Upon application of a signal, the fast diode conducts in the forward direction charging the shunt zener capacitance to the level where the zener conducts and limits the peak. When the signal swings the opposite direction, the fast diode becomes back-biased and prevents fast discharge of shunt capacitance. The fast diode remains back-biased when the signal reverses again to the forward direction and remains off until the input signal rises and exceeds the charge level of the capacitor. When the signal exceeds this level, the fast diode conducts as does the zener. Thus, between successive cycles or pulses the charge in the shunt capacitor holds off the fast diode, preventing capacitive loading of the signal until zener breakdown is reached. Figures 29 and 30 show this method applied to fast-pulse peak limiting.

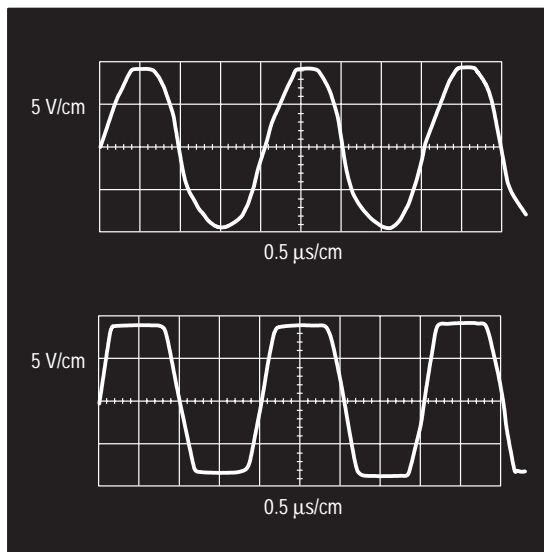
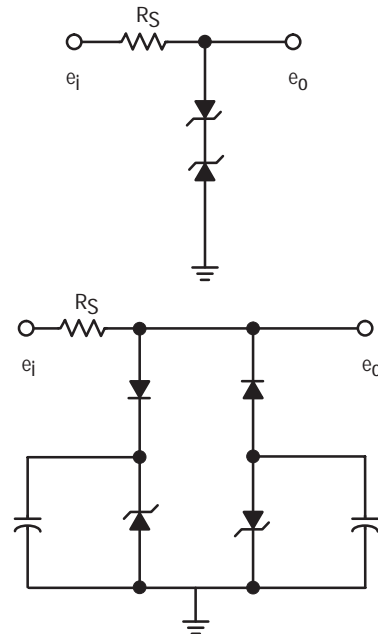


Figure 28. Symmetrical Peak Limiter



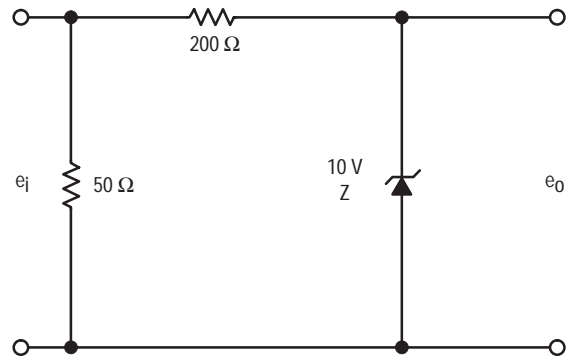
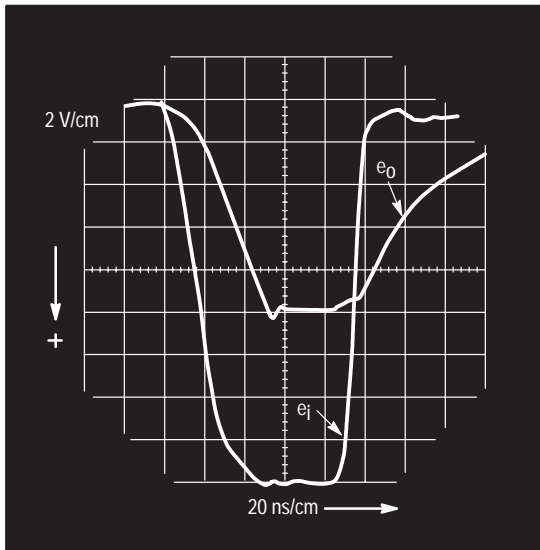


Figure 29. Shunt Clipper

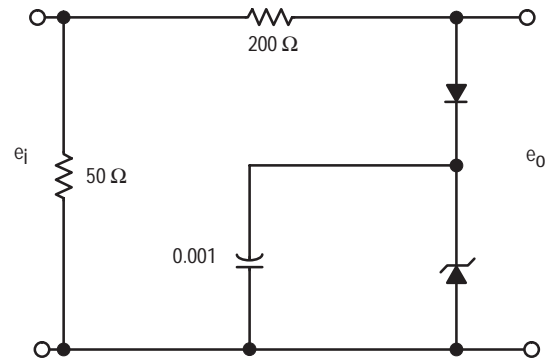
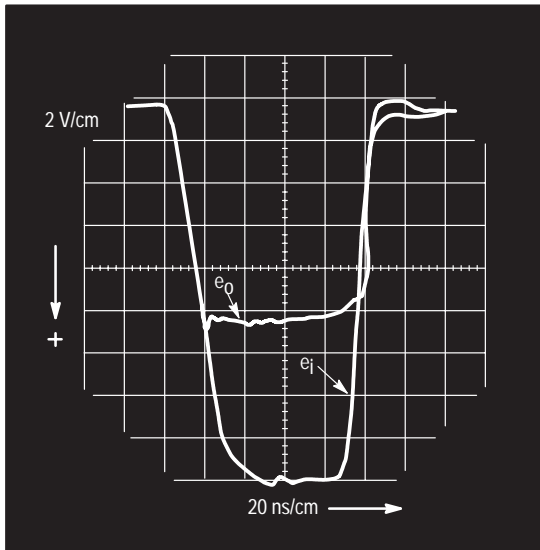


Figure 30. Shunt Clipper with Clamping Network

Figure 31 is a photo of input-output pulse waveforms using a zener alone as a series peak clipper. The smaller output waveform shows the capacitive spike on the leading edge.

Figure 32 clearly points out the advantage of the clamping network.

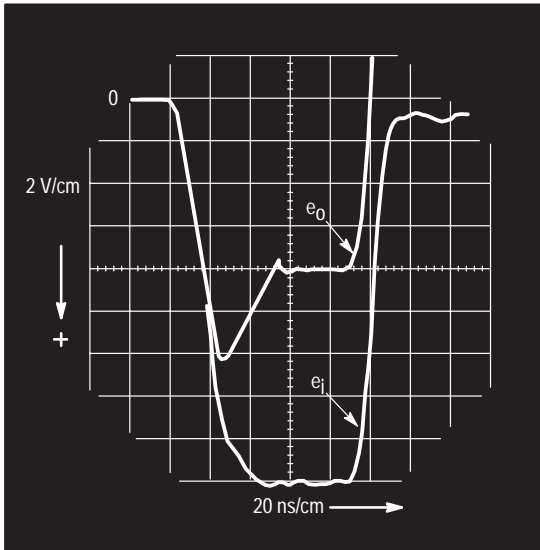


Figure 31. Basic Series Clipper

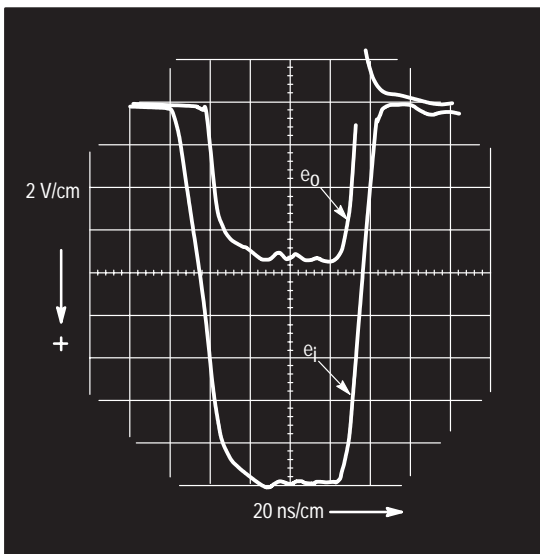
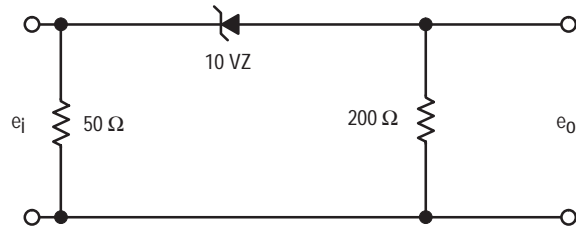
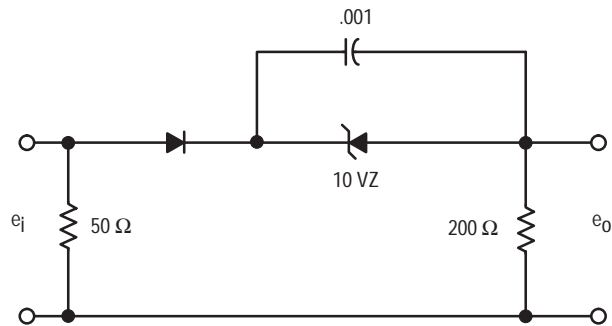


Figure 32. Series Clipper with Clamping Network



# Chapter 5

## TEMPERATURE COMPENSATED ZENERS

### INTRODUCTION

A device which provides reference voltages in a special manner is a reference diode.

As was discussed in the preceding chapters, the zener diode has the unique characteristic of exhibiting either a positive or a negative temperature coefficient, or both. By properly employing this phenomenon in conjunction with other semiconductor devices, it is possible to manufacture a zener reference element exhibiting a very low temperature coefficient when properly used. This type of low temperature coefficient device is referred to as a reference diode.

### INTRODUCTION TO REFERENCE DIODES

The temperature characteristics of the zener diode are discussed in a previous chapter, where it was shown that change in zener voltage with temperature can be significant under severe ambient temperature changes (for example, a 100 V zener can change 12.5 volts from 0 to 125°C). The reference diode (often called the temperature compensated zener or the TC zener) is specially designed to minimize these specific temperature effects.

Design of temperature compensated zeners make possible devices with voltage changes as low as 5 mV from -55 to +100°C, consequently, the advantages of the temperature compensated zener are obvious. In critical applications, as a voltage reference in precision dc power supplies, in high stability oscillators, in digital voltmeters, in frequency meters, in analog-to-digital converters, or in other precision equipment, the temperature compensated zener is a necessity.

Conceivably temperature compensated devices can be designed for any voltage but present devices with optimum voltage temperature characteristics are limited to specific voltages. Each family of temperature compensated zeners is designed by careful selection of its integral parts with special attention to the use conditions (temperature range and current). A distinct operating current is associated with each device. Consequently, changes from the specified operating current can only degrade the voltage-temperature relationships. This will be discussed in more detail later.

The device "drift" or voltage-time stability is critical in some reference applications. Typically zeners and TC zeners offer stability of better than 500 parts per million per 1000 hours.

### TEMPERATURE CHARACTERISTICS OF THE P-N JUNCTION AND COMPENSATION

The voltage of a forward biased P-N junction, at a specific current, will decrease with increasing temperature. Thus, a device so biased displays a negative temperature coefficient (Figure 1). A P-N junction in avalanche (above 5 volts breakdown) will display a positive temperature coefficient; that is, voltage will increase as temperature increases. Due to energy levels of a junction which breaks down below 5 volts, the temperature coefficient is negative.

It follows that various combinations of forward biased junctions and reverse biased junctions may be arranged to achieve temperature compensation. From Figure 2 it can be seen that if the absolute value of voltage change ( $\Delta V$ ) is the same for both the forward biased diode and the zener diode where the temperature has gone from 25°C to 100°C, then the total voltage across the combination will be the same at both temperatures since one  $\Delta V$  is negative and the other positive. Furthermore, if the rate of increase (or decrease) is the same throughout the temperature change, voltage will remain constant. The non-linearity associated with the voltage temperature characteristics is a result of this rate of change not being a perfect match.

$$V_{REF} = V_Z + \Delta V_Z + V_D - \Delta V_D$$

### THE METHODS OF TEMPERATURE COMPENSATION

The effect of temperature is shown in Figure 1. The forward characteristic does not vary significantly with reverse voltage breakdown (zener voltage) rating. A change in ambient temperature from 25° to 100°C produces a shift in the forward curve in the direction of lower voltage (a negative temperature coefficient — in this case about 150 mV change), while the same temperature change produces approximately 1.9 V increase in the zener voltage (a positive coefficient). By combining one or more silicon diodes biased in the forward direction with the P-N biased zener diode as shown in Figure 3, it is possible to compensate almost completely for the zener temperature coefficient. Obviously, with the example shown, 13 junctions would be needed. Usually reference diodes are low voltage devices, using zeners with 6 to 8 volts breakdown and one or two forward diodes.

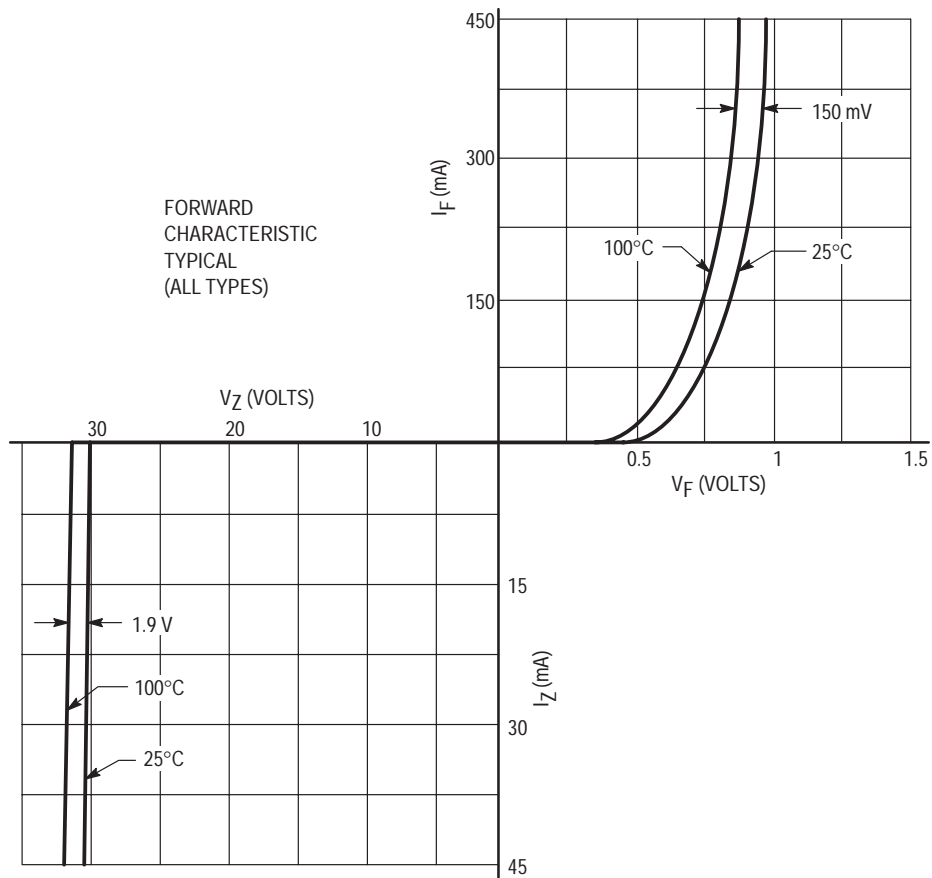


Figure 1. Effects of Temperature on Zener Diode Characteristics

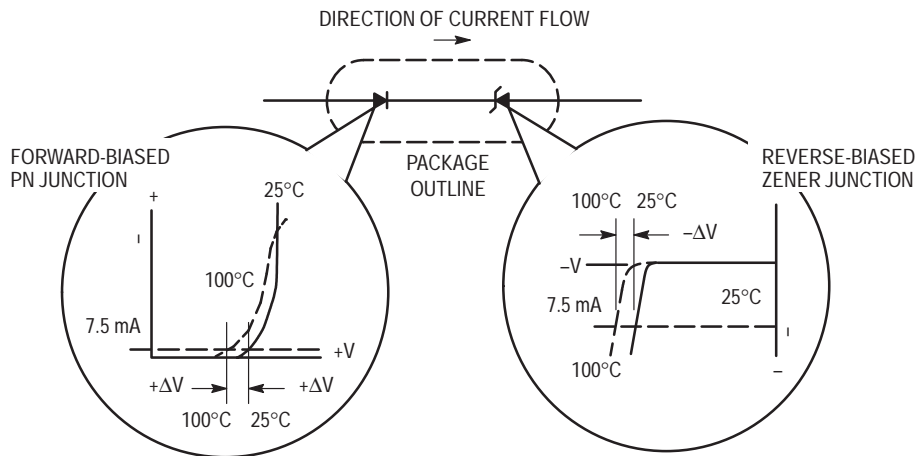


Figure 2. Principle of Temperature Compensation

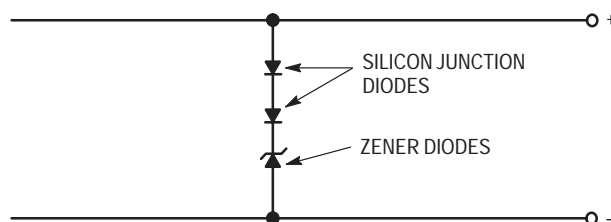


Figure 3. Zener Temperature Compensation with Silicon Forward Junctions

In ac regulator and clipper circuits where zener diodes are normally connected cathode to cathode, the forward biased diode during each half cycle can be chosen with the correct forward temperature coefficient (by stacking, etc.) to correctly compensate for the temperature coefficient of the reverse-biased zener diode. It is possible to compensate for voltage drift with temperature using this method to the extent that zener voltage stabilities on the order of 0.001%/°C are quite feasible.

This technique is sometimes employed where higher wattage devices are required or where the zener is compensated by the emitter base junction of a transistor stage. Consider the example of using discrete components, 1N4001 rectifier and Motorola 5 Watt zener, to obtain compensated voltage-temperature characteristics. Examination of the curve in Figure 4 indicates that a 10 volt zener diode exhibits a temperature coefficient of approximately +5.5 mV/°C. At a current level of 100 mA a temperature coefficient of approximately -2.0 mV/°C is characteristic of the 1N4001 rectifiers. A series connection of three silicon 1N4001 rectifiers produces a total temperature coefficient of approximately -6 mV/°C and a total forward drop of approximately 2.17 volts at 25°C. The combination of three silicon rectifiers and the 10 volt zener diode produces a device with a coefficient of approximately -0.5 mV/°C and a total breakdown voltage at 100 mA of approximately 12.2 volts. Calculation shows this to be a temperature stability of -0.004%/°C.

$$\left( \frac{-0.5 \text{ mV/}^\circ\text{C}}{12.2 \text{ V}} \right) \times 100$$

The temperature compensated zener employs the technique of specially selected dice. This provides optimum voltage temperature characteristics by close control of dice resistivities.

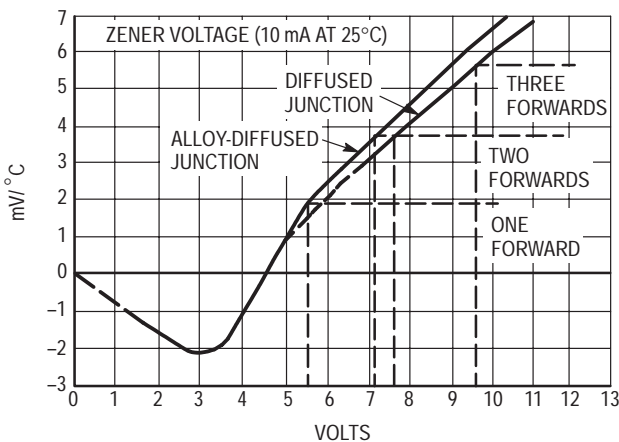


Figure 4.

TEMPERATURE COEFFICIENT STABILITY

Figure 5 shows the voltage-temperature characteristics of the TC diode. It can be seen that the voltage drops slightly with increasing temperature.

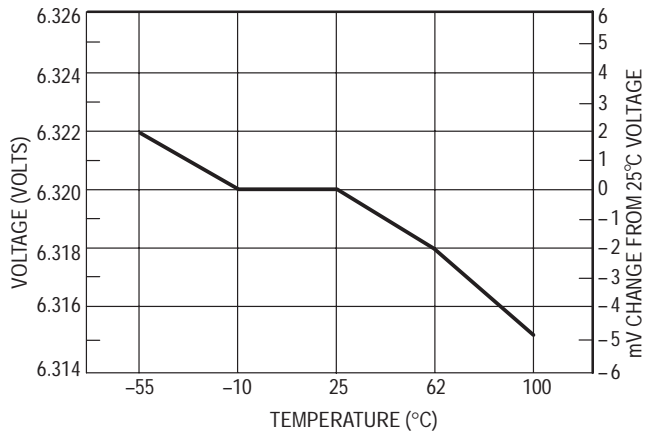


Figure 5. Voltage versus Temperature, Typical for Motorola 1N827 Temperature Compensated Zener Diode

This non-linearity of the voltage temperature characteristic leads to a definition of a representative design parameter  $\Delta V_Z$ . For each device type there is a specified maximum change allowable. The voltage temperature stability measurement consists of voltage measurement at specified temperatures (for the 1N821 Series the temperatures are -55, 0, +25, +75, and +100°C). The voltage readings at each of the temperatures is compared with readings at the other temperatures and the largest voltage change between any of the specified temperatures determines the exact device type. For devices registered prior to complete definition of the voltage temperature stability measurement, the allowable maximum voltage change over the temperature range is derived from the calculation converting %/°C to mV over the temperature range. Under this standard definition, %/°C is merely a nomenclature and the meaningful allowable voltage deviation to be expected becomes the designed parameter.



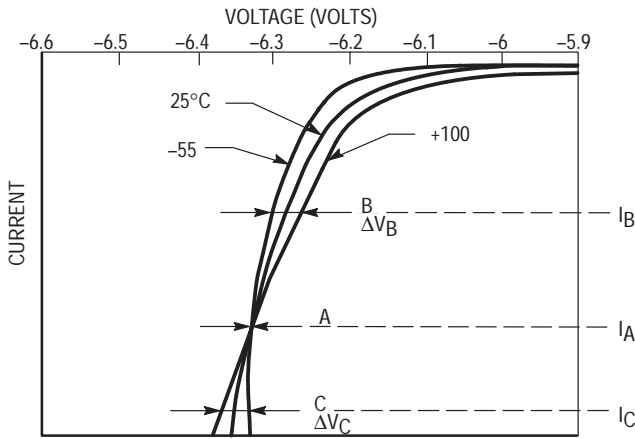
**CURRENT**

Thus far, temperature compensated zeners have been discussed mainly with regard to temperature and voltage. However, the underlying assumption throughout the previous discussion was that current remained constant.

There is a significant change in the temperature coefficient of a unit depending on how much above or below the test current the device is operated.

A particular unit with a 0.01%/°C temperature coefficient at 7.5 mA over a temperature range of -55°C to +100°C could possibly have a 0.0005%/°C temperature coefficient at 11 mA. In fact, there is a particular current which can be determined for each individual unit that will give the lowest TC.

Manufacturing processes are designed so that the yields of low TC units are high at the test specification for current. A unit with a high TC at the test current can have a low TC at some other current. A look at the volt-ampere curves at different temperatures illustrates this point clearly (see Figure 6).



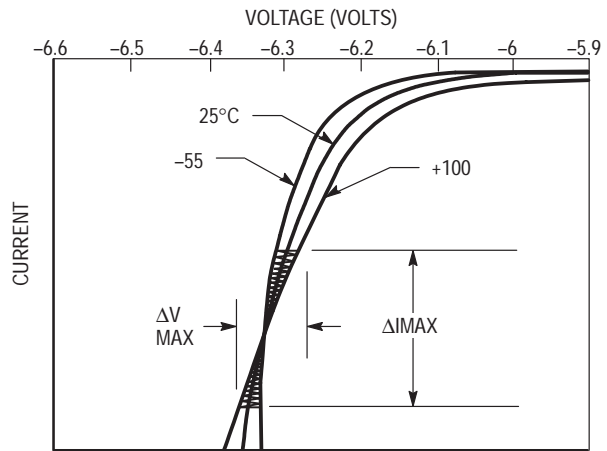
**Figure 6. Voltage-Ampere Curves Showing Crossover at A**

If the three curves intersect at A, then operation at  $I_A$  results in the least amount of voltage deviation due to temperature from the +25°C voltage. At  $I_B$  and  $I_C$  there are greater excursions ( $\Delta V_B$  and  $\Delta V_C$ ) from the +25°C voltage as temperature increases or decreases.

**THE EFFECTS OF POOR CURRENT REGULATION**

If current shifts (randomly or as a function of temperature), then an area of operation can be defined for the temperature compensated zener.

Once again the curves are drawn, this time a shaded area is shown on the graph. The upper and lower extremities denote the maximum current values generated by the current supply while the voltage extremes at each current are shown by the left and right sides of the area, shown in Figure 7.



**Figure 7. Effects of Poorly Regulated Current**

The three volt-ampere curves do not usually cross over at exactly the same point. However, this does not take away from the argument that current regulation is probably the most critical consideration when using temperature-compensated units.

**ZENER IMPEDANCE AND CURRENT REGULATION**

Zener impedance is defined as the slope of the V-I curve at the test point corresponding to the test current. It is measured by superimposing a small ac current on the dc test current and then measuring the resulting ac voltage. This procedure is identical with that used for regular zeners.

Impedance changes with temperature, but the variation is usually small and it can be assumed that the amount of current regulation needed at +25°C will be the same for other temperatures.

As an example, one might want to determine the amount of current regulation necessary for the device described below when the maximum deviation in voltage due to current variation is ±5 millivolts.

$$\begin{aligned}
 V_{ZT} &= 6.32 \text{ V} \\
 I_{ZT} &= 7.5 \text{ mA} \\
 Z_{ZT} &= 15 \Omega @ +25^\circ\text{C} \\
 \Delta V &= \Delta I \cdot V_{ZT} \\
 0.005 &= \Delta I \cdot 15 \\
 \Delta I &= \frac{0.005}{15} = 0.33 \text{ mA}
 \end{aligned}$$

Therefore, the current cannot vary more than 0.33 mA.

The amount of current regulation necessary is:

$$\frac{0.33}{7.5} \times 100\% = 4.5\% \text{ regulation.}$$

If the device of Figure 5 is considered to be the device used in the preceding discussion, it becomes apparent that on the average more voltage variation is due to current fluctuation than is due to temperature variation. Therefore, to obtain a truly stable reference source, the device must be driven from a constant current source.

# Chapter 6

## BASIC VOLTAGE REGULATION USING ZENER DIODES

### BASIC CONCEPTS OF REGULATION

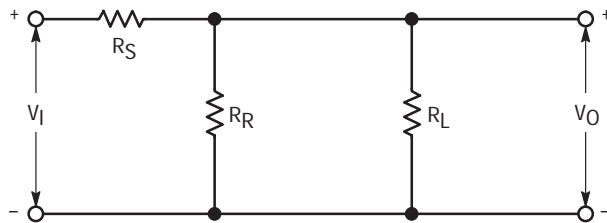
The purpose of any regulator circuit is to minimize output variations with respect to variations in input, temperature, and load requirements. The most obvious use of a regulator is in the design of a power supply, but any circuit that incorporates regulatory technique to give a controlled output or function can be considered as a regulator. In general, to provide a regulated output voltage, electronic circuitry will be used to pass an output voltage that is significantly lower than the input voltage and block all voltage in excess of the desired output. Allocations should also be made in the regulation circuitry to maintain this output voltage for variation in load current demand.

There are some basic rules of thumb for the electrical requirements of the electronic circuitry in order for it to provide regulation. Number one, the output impedance should be kept as low as possible. Number two, a controlling reference needs to be established that is relatively insensitive to the prevailing variables. In order to illustrate the importance of these rules, an analysis of some simple regulator circuits will point out the validity of the statements. The circuit of Figure 1 can be considered a regulator. This circuit will serve to illustrate the importance of a low output impedance.

The resistors  $R_S$  and  $R_R$  can be considered as the source and regulator impedances, respectively.

The output of the circuit is:

$$V_O = V_I \times \frac{R_R R_L}{R_R + R_L} \bigg/ \left( R_S + \frac{R_R R_L}{R_R + R_L} \right) = \frac{V_I}{\frac{R_S}{R_L} + \frac{R_S}{R_R} + 1} \quad (1)$$



**Figure 1. Shunt Resistance Regulator**

For a given incremental change in  $V_I$ , the changes in  $V_O$  will be:

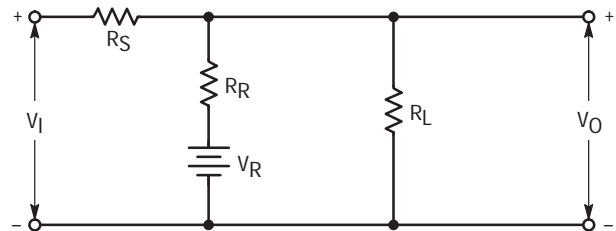
$$\Delta V_O = \Delta V_I \left( \frac{1}{\frac{R_S}{R_L} + \frac{R_S}{R_R} + 1} \right) \quad (2)$$

Assuming  $R_L$  fixed at some constant value, it is obvious from equation (2) that in order to minimize changes in  $V_O$  for variations in  $V_I$ , the shunt resistor  $R_R$  should be made

as small as possible with respect to the source resistor  $R_S$ . Obviously, the better this relation becomes, the larger  $V_I$  is going to have to be for the same  $V_O$ , and not until the ratio of  $R_S$  to  $R_R$  reaches infinity will the output be held entirely constant for variation in  $V_I$ . This, of course, is an impossibility, but it does stress the fact that the regulation improves as the output impedance becomes lower and lower. Where the output impedance of Figure 1 is given by

$$R_O = \frac{R_S R_R}{R_S + R_R} \quad (3)$$

It is apparent from this relation that as regulation is improving with  $R_S$  increasing and  $R_R$  decreasing the output impedance  $R_O$  is decreasing, and is approximately equal to  $R_R$  as the ratio is 10 times or greater. The regulation of this circuit can be greatly improved by inserting a reference source of voltage in series with  $R_R$  such as Figure 2.



**Figure 2. Regulator with Battery Reference Source**

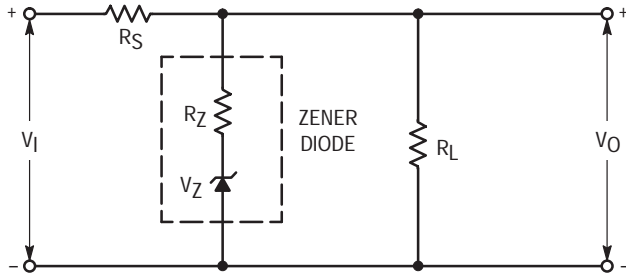
The resistance  $R_R$  represents the internal impedance of the battery. For this circuit, the output is

$$V_O = V_R + V_I \frac{V}{\frac{R_S}{R_L} + \frac{R_S}{R_R} + 1} \quad (4)$$

Then for incremental changes in the input  $V_I$ , the changes in  $V_O$  will be dependent on the second term of equation (4), which again makes the regulation dependent on the ratio of  $R_S$  to  $R_R$ . Where changes in the output voltage or the regulation of the circuit in Figure 1 were directly and solely dependent upon the input voltage and output impedance, the regulation of circuit 2 will have an output that varies about the reference source  $V_R$  in accordance with the magnitude of battery resistance  $R_R$  and its fluctuations for changes in  $V_I$ . Theoretically, if a perfect battery were used, that is,  $V_R$  is constant and  $R_R$  is zero, the circuit would be a perfect regulator. In other words, in line with the basic rules of thumb the circuit exhibits optimum regulation with an output impedance of zero, and a constant reference source.

For regulator application, a zener diode can be used instead of a battery with a number of advantages. A battery's resistance and nominal voltage will change with age and load demand; the Motorola zener diode characteristics remain unchanged when operating within its specified limits. Any

voltage value from a couple of volts to hundreds of volts is available with zener diodes, where conventional batteries are limited in the nominal values available. Also, the zener presents a definite size advantage, and is less expensive than a battery because it is permanent and need not be regularly replaced. The basic zener diode shunt regulator circuit is shown in Figure 3.



**Figure 3. Basic Zener Diode Shunt Regulator**

Depending upon the operating conditions of the device, a zener diode will exhibit some relatively low zener impedance  $R_Z$  and have a specified breakover voltage of  $V_Z$  that is essentially constant. These inherent characteristics make the zener diode suited for voltage regulator applications.

### DESIGNING THE ZENER SHUNT REGULATOR

For any given application of a zener diode shunt regulator, it will be required to know the input voltage variations and output load requirements. The calculation of component values will be directly dependent upon the circuit requirements. The input may be constant or have maximum and minimum values depending upon the natural regulation or waveform of the supply source. The output voltage will be determined by the designer's choice of  $V_Z$  and the circuit requirements. The actual value of  $V_Z$  will be dependent upon the manufacturer's tolerance and some small variation for different zener currents and operating temperatures.

For all practical purposes, the value of  $V_Z$  as specified on the manufacturer's data sheet can be used to approximate  $V_O$  in computing component values. The requirement for load current will be known and will vary within some given range of  $I_L(\min)$  to  $I_L(\max)$ .

The design objective of Figure 3 is to determine the proper values of the series resistance,  $R_S$ , and zener power dissipation,  $P_Z$ . A general solution for these values can be developed as follows, when the following conditions are known:

$V_I$  (input voltage) from  $V_I(\min)$  to  $V_I(\max)$

$V_O$  (output voltage) from  $V_Z(\min)$  to  $V_Z(\max)$

$I_L$  (load current) from  $I_L(\min)$  to  $I_L(\max)$

The value of  $R_S$  must be of such a value so that the zener current will not drop below a minimum value of  $I_Z(\min)$ . This minimum zener current is mandatory to keep the device in

the breakover region in order to maintain the zener voltage reference. The minimum current can be either chosen at some point beyond the knee or found on the manufacturer's data sheet ( $I_{ZK}$ ). The basic voltage loop equation for this circuit is:

$$V_I = (I_Z + I_L)R_S + V_Z \quad (5)$$

The minimum zener current will occur when  $V_I$  is minimum,  $V_Z$  is maximum, and  $I_L$  is maximum, then solving for  $R_S$ , we have:

$$R_S = \frac{V_I(\min) - V_Z(\max)}{I_Z(\min) + I_L(\max)} \quad (6)$$

Having found  $R_S$ , we can determine the maximum power dissipation  $P_Z$  for the zener diode.

$$P_Z(\max) = I_Z(\max) V_Z(\max) \quad (7)$$

Where:

$$I_Z(\max) = \frac{V_I(\max) - V_Z(\min)}{R_S} - I_L(\min) \quad (8)$$

Therefore:

$$P_Z(\max) = \left[ \frac{V_I(\max) - V_Z(\min)}{R_S} - I_L(\min) \right] V_Z(\max) \quad (9)$$

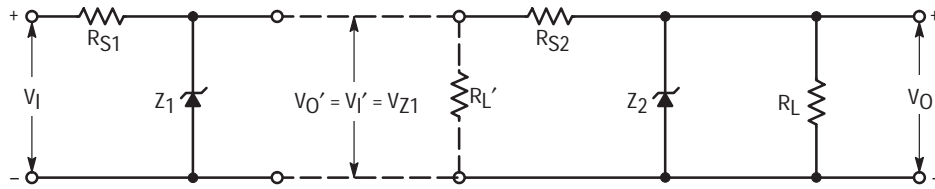
Once the basic regulator components values have been determined, adequate considerations will have to be given to the variation in  $V_O$ . The changes in  $V_O$  are a function of four different factors; namely, changes in  $V_I$ ,  $I_L$ , temperature, and the value of zener impedance,  $R_Z$ . These changes in  $V_O$  can be expressed as:

$$\Delta V_O = \frac{\Delta V_I}{1 + \frac{R_S}{R_Z} + \frac{R_S}{R_L}} - \frac{R_S R_Z}{R_S + R_Z} \Delta I_L + TC \Delta T V_Z \quad (10)$$

The value of  $\Delta V_O$  as calculated with equation (10) will quite probably be slightly different from the actual value when measured empirically. For all practical purposes though, this difference will be insignificant for regulator designs utilizing the conventional commercial line of zener diodes.

Obviously to precisely predict  $\Delta V_O$  with a given zener diode, exact information would be needed about the zener impedance and temperature coefficient throughout the variation of zener current. The "worst case" change can only be approximated by using maximum zener impedance and with typical temperature coefficient.

The basic zener shunt regulator can be modified to minimize the effects of each term in the regulation equation (10). Taking one term at a time, it is apparent that the regulation or changes in output  $\Delta V_O$  will be improved if the magnitude of  $\Delta V_I$  is reduced. A practical and widely used technique to reduce input variation is to cascade zener shunt regulators such as shown in Figure 4.



**Figure 4. Cascaded Zener Shunt Regulators Reduce  $\Delta V_O$  by Reducing  $\Delta V_I$  to the Succeeding Stages**

This, in essence, is a regulator driven with a pre-regulator so that the over all regulation is the product of both. The regulation or changes in output voltage is determined by:

$$\Delta V_O = \frac{\Delta V_{Z1}}{1 + \frac{R_{S2}}{R_L} + \frac{R_{S2}}{R_{Z2}}} - \frac{R_{S2}R_{Z2}}{R_{S2} + R_{Z2}} \Delta I_L + TC_2 \Delta T V_{Z2} \quad (11)$$

Where:

$$\Delta V_{Z1} = \Delta V_{O'} = \frac{\Delta V_I}{1 + \frac{R_{S1}}{R_{L'}} + \frac{R_{S1}}{R_{Z1}}} - \frac{R_{S1}R_{Z1}}{R_{S1} + R_{Z1}} \Delta I_{L'} + TC_1 \Delta T V_{Z1} \quad (12)$$

$$R_{L'} = R_{S2} + \frac{R_L R_{Z2}}{R_L + R_{Z2}} \text{ and } I_{L'} = I_L + I_{Z2}$$

The changes in output with respect to changes in input for both stages assuming the temperature and load are constant is

$$\frac{\Delta V_O}{\Delta V_{Z1}} = \frac{\Delta V_O}{\Delta V_{O'}} = \text{Regulation of second stage} \quad (13)$$

$$\frac{\Delta V_{O'}}{\Delta V_I} = \text{Regulation of first stage} \quad (14)$$

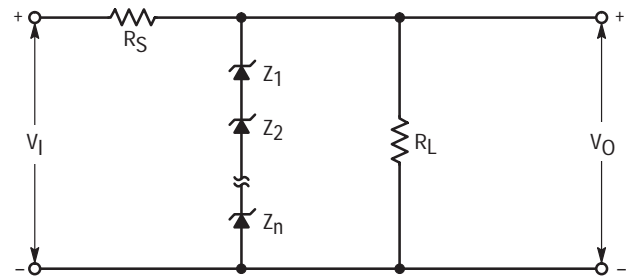
$$\frac{\Delta V_O}{\Delta V_I} = \frac{\Delta V_O}{\Delta V_{O'}} \times \frac{\Delta V_{O'}}{\Delta V_I} = \text{Combined regulation} \quad (15)$$

Obviously, this technique will vastly improve overall regulation where the input fluctuates over a relatively wide range. As an example, let's say the input varies by  $\pm 20\%$  and the regulation of each individual stage reduces the variation by a factor of  $1/20$ . This then gives an overall output variation of  $\pm 20\% \times (1/20)^2$  or  $\pm 0.05\%$ .

The next two factors in equation (10) affecting regulation are changes in load current and temperature excursions. In order to minimize changes for load current variation, the output impedance  $R_Z R_S / (R_Z + R_S)$  will have to be reduced. This can only be done by having a lower zener impedance because the value of  $R_S$  is fixed by circuit requirements. There are basically two ways that a lower zener impedance can be achieved. One, a higher wattage device can be used which allows for an increase in zener current of which will reduce the impedance. The other technique is to series lower voltage devices to obtain the desired equivalent voltage, so

that the sum of the impedance is less than that for a single high voltage device. So to speak, this technique will kill two birds with one stone, as it can also be used to minimize temperature induced variations of the regulator.

In most regulator applications, the single most detrimental factor affecting regulation is that of variation in junction temperature. The junction temperature is a function of both the ambient temperature and that of self heating. In order to illustrate how the overall temperature coefficient is improved with series lower voltage zener, a mathematical relationship can be developed. Consider the diagram of Figure 5.



**Figure 5. Series Zener Improve Dynamic Impedance and Temperature Coefficient**

With the temperature coefficient TC defined as the % change per  $^{\circ}\text{C}$ , the change in output for a given temperature range will equal some overall TC x  $\Delta T$  x Total  $V_Z$ . Such as

$$\Delta V_O(\Delta T) = TC \Delta T (V_{Z1} + V_{Z2} + \dots + V_{ZN}) \quad (16)$$

Obviously, the change in output will also be equal to the sum of the changes as attributed from each zener.

$$\Delta V_O(\Delta T) = \Delta T (TC_1 V_{Z1} + TC_2 V_{Z2} + \dots + TC_N V_{ZN}) \quad (17)$$

Setting the two equations equal to each other and solving for the overall TC, we get

$$TC \Delta T (V_{Z1} + V_{Z2} + \dots + V_{ZN}) = \Delta T (TC_1 V_{Z1} + TC_2 V_{Z2} + \dots + TC_N V_{ZN}) \quad (18)$$

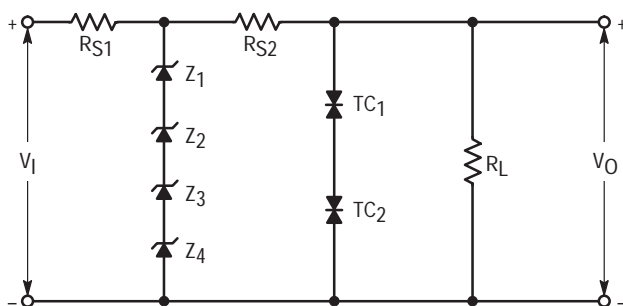
$$TC = \frac{TC_1 V_{Z1} + TC_2 V_{Z2} + \dots + TC_N V_{ZN}}{V_{Z1} + V_{Z2} + \dots + V_{ZN}} \quad (19)$$

For equation (19) the overall temperature coefficient for any combination of series zeners can be calculated. Say for instance several identical zeners in series replace a single higher voltage zener. The new overall temperature coefficient will now be that of one of the low voltage devices. This allows the designer to go to the manufacturer's data sheet and

select a combination of low TC zener diodes in place of the single higher TC devices. Generally speaking, the technique of using multiple devices will also yield a lower dynamic impedance. Advantages of this technique are best demonstrated by example. Consider a 5 watt diode with a nominal zener voltage of 10 volts exhibits approximately 0.055% change in voltage per degree centigrade, a 20 volt unit approximately 0.075%/°C, and a 100 volt unit approximately 0.1%/°C. In the case of the 100 volt diode, five 20 volt diodes could be connected together to provide the correct voltage reference, but the overall temperature coefficient would remain that of the low voltage units, i.e. 0.075%/°C. It should also be noted that the same series combination improves the overall zener impedance in addition to the temperature coefficient. A 20 volt, 5 watt Motorola zener diode has a maximum zener impedance of 3 ohms, compared to the 90 ohms impedance which is maximum for a 100 volt unit. Although these impedances are measured at different current levels, the series impedance of five 20 volt zener diodes is still much lower than that of a single 100 volt zener diode at the test current specified on the data sheet.

For the ultimate in zener shunt regulator performance, the aforementioned techniques can be combined with the proper selection of devices to yield an overall improvement in regulation. For instance, a multiple string of low voltage zener diodes can be used as a preregulator, with a series combination of zero TC reference diodes in the final stage such as Figure 6.

The first stage will reduce the large variation in  $V_I$  to some relatively low level, i.e.  $\Delta V_Z$ . This  $\Delta V_Z$  is optimized by utilizing a series combination of zeners to reduce the overall TC and  $\Delta V_Z$ . Because of this small fluctuation of input to the second stage, and if  $R_L$  is constant, the biasing current of the TC units can be maintained at their specified level. This will give an output that is very precise and not significantly affected by changes in input voltage or junction temperature.



**Figure 6. Series Zeners Cascaded With Series Reference Diodes for Improved Zener Shunt Regulation**

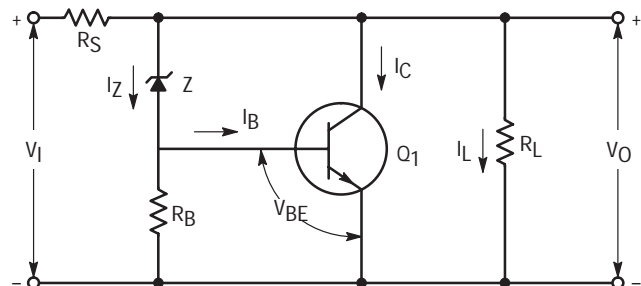
The basic zener shunt regulator exhibits some inherent limitations to the designer. First of all, the zener is limited to its particular power dissipating rating which may be less than the required amount for a particular situation. The total magnitude of dissipation can be increased to some degree by utilizing series or parallel units. Zeners in series present

few problems because individual voltages are additive and the devices all carry the same current and the extent that this technique can be used is only restricted by the feasibility of circuit parameters and cost. On the other hand, caution must be taken when attempting to parallel zener diodes. If the devices are not closely matched so that they all break over at the same voltage, the low voltage device will go into conduction first and ultimately carry all the current. In order to avoid this situation, the diodes should be matched for equal current sharing.

**EXTENDING POWER AND CURRENT RANGE**

The most common practice for extending the power handling capabilities of a regulator is to incorporate transistors in the design. This technique is discussed in detail in the following sections of this chapter. The second disadvantage to the basic zener shunt regulator is that because the device does not have a gain function, a feedback system is not possible with just the zener resistor combination. For very precise regulators, the design will normally be an electronic circuit consisting of transistor devices for control, probably a closed loop feedback system with a zener device as the basic referencing element.

The concept of regulation can be further extended and improved with the addition of transistors as the power absorbing elements to the zener diodes establishing a reference. There are three basic techniques used that combine zener diodes and transistors for voltage regulation. The shunt transistor type shown in Figure 7 will extend the power handling capabilities of the basic shunt regulator, and exhibit marked improvement in regulation.



**Figure 7. Basic Transistor Shunt Regulator**

In this configuration the source resistance must be large enough to absorb the overvoltage in the same manner as in the conventional zener shunt regulator. Most of the shunt regulating current in this circuit will pass through the transistor reducing the current requirements of the zener diode by essentially the dc current gain of the transistor  $h_{FE}$ . Where the total regulating shunt current is:

$$I_S = I_Z + I_C = I_Z + I_B h_{FE}$$

where

$$I_Z = I_B + I_{RB} \text{ and } I_B \gg I_{RB}$$

therefore

$$I_S \approx I_Z + I_Z h_{FE} = I_Z (1 + h_{FE}) \quad (20)$$

The output voltage is the reference voltage  $V_Z$  plus the forward junction drop from base to emitter  $V_{BE}$  of the transistor.

$$V_O = V_Z + V_{BE} \quad (21)$$

The values of components and their operating condition is dictated by the specific input and output requirements and the characteristics of the designer's chosen devices, as shown in the following relations:

$$R_S = \frac{V_{I(\min)} - V_{O(\max)}}{I_{Z(\min)} [1 + h_{FE(\min)}] + I_{L(\max)}} \quad (22)$$

$$R_B = \frac{V_{I(\min)} - V_{Z(\max)}}{I_{Z(\min)}} \quad (23)$$

$$PD_Z = I_{Z(\max)} V_{Z(\max)} \quad (24)$$

when

$$I_{Z(\max)} = \left[ \frac{V_{I(\max)} - V_{O(\min)}}{R_S} - I_{L(\min)} \right] \left( \frac{1}{1 + h_{FE(\min)}} \right) \quad (25)$$

hence

$$PD_Z = \left[ \frac{V_{I(\max)} - V_{O(\min)}}{R_S} - I_{L(\min)} \right] \left( \frac{V_{Z(\max)}}{1 + h_{FE(\min)}} \right) \quad (26)$$

$$PD_Q = \left[ \frac{V_{I(\max)} - V_{O(\min)}}{R_S} - I_{L(\min)} \right] (V_{O(\max)}) \quad (27)$$

Regulation with this circuit is derived in essentially the same manner as in the shunt zener circuit, where the output impedance is low and the output voltage is a function of the reference voltage. The regulation is improved with this configuration because the small signal output impedance is reduced by the gain of  $Q_1$  by  $1/h_{FE}$ .

One other highly desirable feature of this type of regulator is that the output is somewhat self compensating for temperature changes by the opposing changes in  $V_Z$  and  $V_{BE}$  for  $V_Z \approx 10$  volts. With the zener having a positive  $2 \text{ mV}/^\circ\text{C}$  TC and the transistor base to emitter being a negative  $2 \text{ mV}/^\circ\text{C}$  TC, therefore, a change in one is cancelled by the change in the other. Even though this circuit is a very effective regulator it is somewhat undesirable from an efficiency standpoint. Because the magnitude of  $R_S$  is required to be large, and it must carry the entire input current, a large percentage of power is lost from input to output.

### EMITTER FOLLOWER REGULATOR

Another basic technique of transistor-zener regulation is that of the emitter follower type shown in Figure 8.

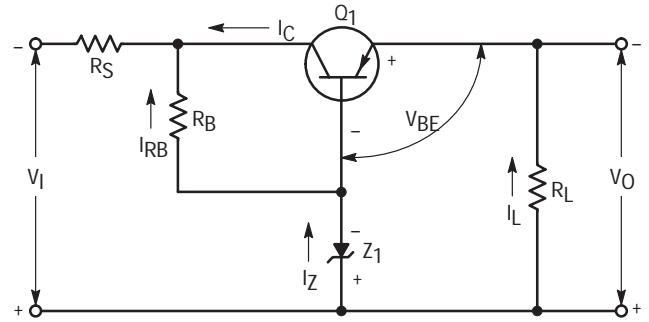


Figure 8. Emitter Follower Regulator

This circuit has the desirable feature of using a series transistor to absorb overvoltages instead of a large fixed resistor, thereby giving a significant improvement in efficiency over the shunt type regulator. The transistor must be capable of carrying the entire load current and withstanding voltages equal to the input voltage minus the load voltage. This, of course, imposes a much more stringent power handling requirement upon the transistor than was required in the shunt regulator. The output voltage is a function of the zener reference voltage and the base to emitter drop of  $Q_1$  as expressed by the equation (28).

$$V_O = V_Z - V_{BE} \quad (28)$$

The load current is approximately equal to the transistor collector current, such as shown in equation (29).

$$I_{L(\max)} \approx I_{C(\max)} \quad (29)$$

The designer must select a transistor that will meet the following basic requirements:

$$P_D \approx (V_{I(\max)} - V_O) I_{L(\max)}$$

$$I_{C(\max)} \approx I_{L(\max)}$$

$$BV_{CES} \geq (V_{I(\max)} - V_O) \quad (30)$$

Depending upon the designer's choice of a transistor and the imposed circuit requirements, the operation conditions of the circuit are expressed by the following equations:

$$V_Z = V_O + V_{BE}$$

$$= V_O + I_{L(\max)}/g_{FE(\min)} @ I_{L(\max)}$$

$$R_S = \frac{V_{I(\min)} - V_Z - V_{CE(\min)} @ I_{L(\max)}}{I_{L(\max)}} \quad (31)$$

Where  $V_{CE(\min)}$  is an arbitrary value of minimum collector to emitter voltage and  $g_{FE}$  is the transconductance.

This is sufficient to keep the transistor out of saturation, which is usually about 2 volts.

$$R_B = \frac{V_{CE(\min)} @ I_{L(\max)}}{I_{L(\max)}/h_{FE(\min)} @ I_{L(\max)} + I_{Z(\min)}} \quad (32)$$

$$I_{Z(\max)} = \frac{V_I(\max) - V_Z}{R_B + R_Z} \quad (33)$$

$$PD_Z = I_{Z(\max)} V_Z \quad (34)$$

$$\text{Actual } PD_Q = (V_I(\max) - V_O) I_{L(\max)} \quad (35)$$

There are two primary factors that effect the regulation most in a circuit of this type. First of all, the zener current may vary over a considerable range as the input changes from minimum to maximum and this, of course, may have a significant effect on the value of  $V_Z$  and therefore  $V_O$ . Secondly,  $V_Z$  and  $V_{BE}$  will both be effected by temperature changes which are additive on their effect of output voltage. This can be seen by altering equation (28) to show changes in  $V_O$  as dependent on temperature, see equation (36).

$$V_O(\Delta T) = \Delta T[(+TC) V_Z - (-TC) V_{BE}] \quad (36)$$

The effects of these detrimental factors can be minimized by replacing the bleeder resistor  $R_B$  with a constant current source and the zener with a reference diode in series with a forward biased diode (see Figure 9).

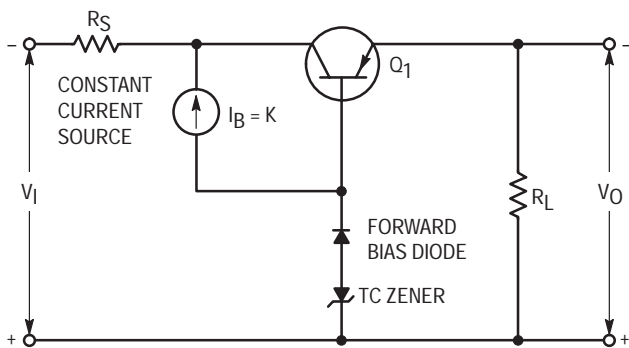


Figure 9. Improved Emitter Follower Regulator

The constant current source can be either a current limiter diode or a transistor source. The current limiter diode is ideally suited for applications of this type, because it will supply the same biasing current irregardless of collector to base voltage swing as long as it is within the voltage limits of the device. This technique will overcome changes in  $V_Z$  for changes in  $I_Z$  and temperature, but changes in  $V_{BE}$  due to load current changes are still directly reflected upon the

output. This can be reduced somewhat by combining a transistor with the zener for the shunt control element as illustrated in Figure 10.

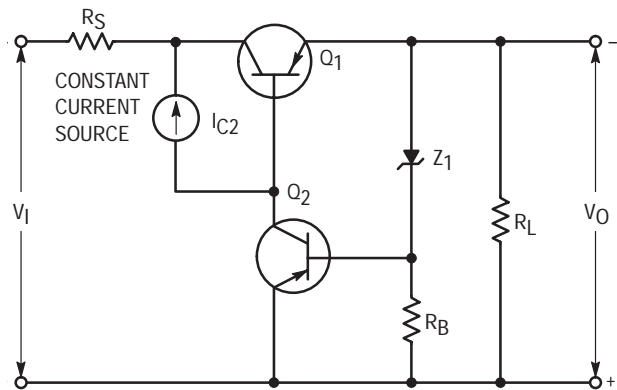


Figure 10. Series Pass Regulator

This is the third basic technique used for transistor-zener regulators. This technique or at least a variation of it, finds the widest use in practical applications. In this circuit the transistor  $Q_1$  is still the series control device operating as an emitter follower. The output voltage is now established by the transistor  $Q_2$  base to emitter voltage and the zener voltage. Because the zener is only supplying base drive to  $Q_2$ , and it derives its bias from the output, the zener current remains essential constant, which minimizes changes in  $V_Z$  due to  $I_Z$  excursions. Also, it may be possible ( $V_Z \approx 10$  V) to match the zener to the base-emitter junction of  $Q_2$  for an output that is insensitive to temperature changes. The constant current source looks like a very high load impedance to the collector of  $Q_2$  thus assuming a very high voltage gain. There are three primary advantages gained with this configuration over the basic emitter follower:

1. The increased voltage gain of the circuit with the addition of  $Q_2$  will improve regulation for changes in both load and input.
2. The zener current excursions are reduced, thereby improving regulation.
3. For certain voltages the configuration allows good temperature compensation by matching the temperature characteristics of the zener to the base-emitter junction of  $Q_2$ .

The series pass regulator is superior to the other transistor regulators thus far discussed. It has good efficiency, better stability and regulation, and is simple enough to be economically practical for a large percentage of applications.

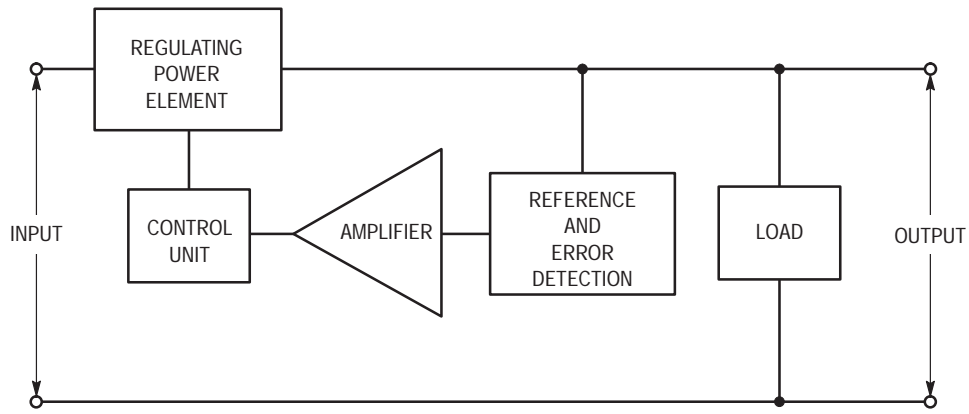


Figure 11. Block Diagram of Regulator with Feedback

**EMPLOYING FEEDBACK FOR OPTIMUM REGULATION**

The regulators discussed thus far do not employ any feedback techniques for precise control and compensation and, therefore, find limited use where an ultra precise regulator is required. In the more sophisticated regulators some form of error detection is incorporated and amplified through a feedback network to closely control the power elements as illustrated in the block diagram of Figure 11.

Regulating circuits of this type will vary in complexity and configuration from application to application. This technique can best be illustrated with a couple of actual circuits of this type. The feedback regulators will generally be some form of series pass regulator, for optimum performance and efficiency. A practical circuit of this type that is extensively utilized is shown in Figure 12.

In this circuit, the zener establishes a reference level for the differential amplifier composed of Q<sub>4</sub> and Q<sub>5</sub> which will set the base drive for the control transistor Q<sub>3</sub> to regulate the series high gain transistor combination of Q<sub>1</sub> and Q<sub>2</sub>. The differential amplifier samples the output at the voltage dividing network of R<sub>8</sub>, R<sub>9</sub>, and R<sub>10</sub>. This is compared to the reference voltage provided by the zener Z<sub>1</sub>. The difference, if any, is amplified and fed back to the control elements. By adjusting the potentiometer, R<sub>9</sub>, the output level can be set to any desired value within the range of the supply. (The output voltage is set by the relation  $V_O = V_Z[(R_X + R_Y)/R_X]$ .) By matching the transistor Q<sub>4</sub> and Q<sub>5</sub> for variations in V<sub>BE</sub> and gain with temperature changes and incorporating a temperature compensated diode as the reference, the circuit will be ultra stable to temperature effects. The regulation and stability of this circuit is very good, and for this reason is used in a large percentage of commercial power supplies.

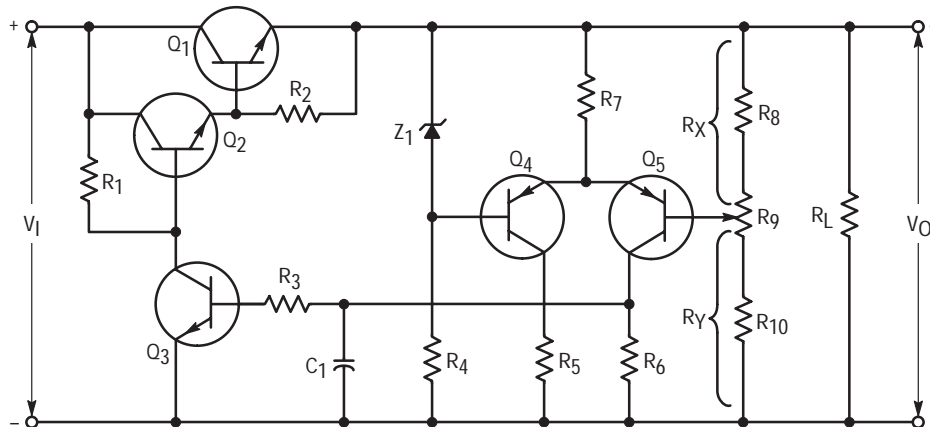
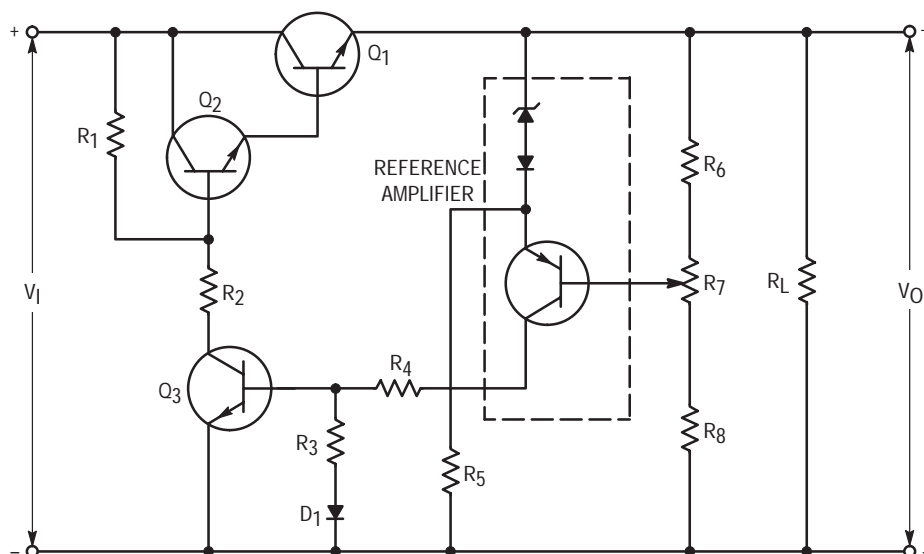


Figure 12. Series Pass Regulator with Error Detection and Feedback Amplification Derived from a Differential Amplifier





**Figure 13. Series Pass Regulator with Temperature Compensated Reference Amplifier**

Another variation of the feedback series pass regulator is shown in Figure 13. This circuit incorporates a stable temperature compensated reference amplifier as the primary control element.

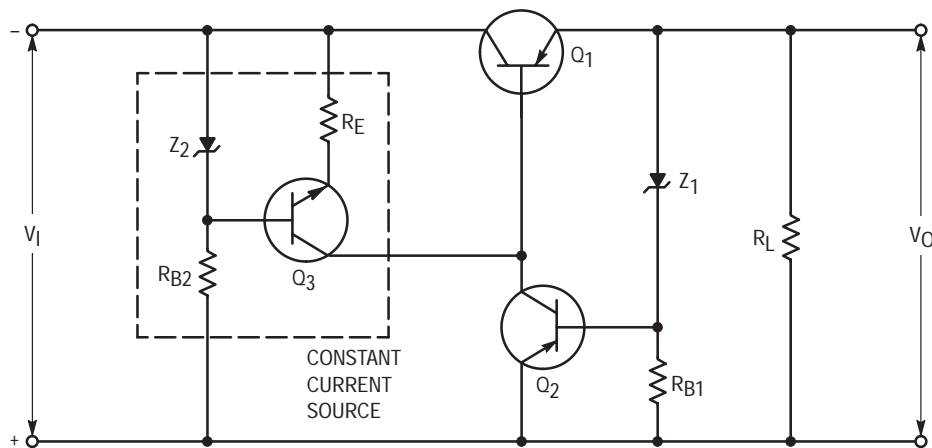
This circuit also employs error detection and amplified feedback compensation. It is an improved version over the basic series pass regulator shown in Figure 10. The series element is composed of a Darlington high gain configuration formed by Q<sub>1</sub> and Q<sub>2</sub> for an improved regulation factor. The combined gain of the reference amplifier and Q<sub>3</sub> is incorporated to control the series unit. This reduced the required collector current change of the reference amplifier to control the regulator so that the bias current remains close to the specified current for low temperature coefficient. Also the germanium diode D<sub>1</sub> will compensate for the base to emitter change in Q<sub>3</sub> and keep the reference amplifier collector biasing current fairly constant with temperature changes. Proper biasing of the zener and transistor in the reference amplifier must be adhered to if the output voltage changes are to be minimized.

**CONSTANT CURRENT SOURCES FOR REGULATOR APPLICATIONS**

Several places throughout this chapter emphasize the need for maintaining a constant current level in the various biasing circuits for optimum regulation. As was mentioned previously in the discussion on the basic series pass regulator, the current limiter diode can be effectively used for the purpose.

Aside from the current limiter diode a transistorized source can be used. A widely used technique is shown incorporated in a basic series pass regulator in Figure 14.

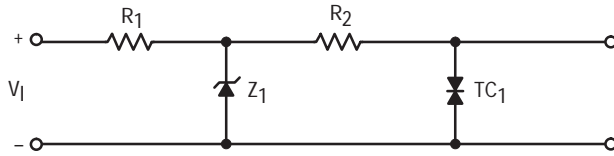
The circuit is used as a preregulated current source to supply the biasing current to the transistor Q<sub>2</sub>. The constant current circuit is seldom used alone, but does find wide use in conjunction with voltage regulators to supply biasing current to transistors or reference diodes for stable operation. The Zener Z<sub>2</sub> establishes a fixed voltage across R<sub>E</sub> and the base to emitter of Q<sub>3</sub>. This gives an emitter current of  $I_E = (V_Z - V_{BE})/R_E$  which will vary only slightly for changes in input voltage and temperature.



**Figure 14. Constant Current Source Incorporated in a Basic Regulator Circuit**

**IMPEDANCE CANCELLATION**

One of the most common applications of zener diodes is in the general category of reference voltage supplies. The function of the zener diode in such applications is to provide a stable reference voltage during input voltage variations. This function is complicated by the zener diode impedance, which effectively causes an incremental change in zener breakdown voltage with changing zener current.



**Figure 15. Impedance Cancellation with An Uncompensated Zener**

It is possible, however, by employing a bridge type circuit which includes the zener diode and current regulating resistance in its branch legs, to effectively cancel the effect of the zener impedance. Consider the circuit of Figure 15 as an example. This is the common configuration for a zener diode voltage regulating system. The zener impedance at 20 mA of a 1N4740 diode is typically 2 ohms. If the supply voltage now changes from 30 V to 40 V, the diode current determined by R<sub>1</sub> changes from 20 to 30 mA; the average zener impedance becomes 1.9 ohms; and the reference voltage shifts by 19 mV. This represents a reference change of .19%, an amount far too large for an input change of 30% in most reference supplies.

The effect of zener impedance change with current is relatively small for most input changes and will be neglected for this analysis. Assuming constant zener impedance, the zener voltage is approximated by

$$V'_Z = V_Z + Z(I'_Z - I_Z) \tag{37}$$

where  $V'_Z$  is the new zener voltage  
 $V_Z$  is the former zener voltage  
 $I'_Z$  is the new zener current  
 $I_Z$  is the former zener current flowing at  $V_Z$   
 $Z$  is the zener impedance

Then  $\Delta V_Z = Z\Delta I_Z$

Let the input voltage  $V_1$  in Figure 15 increase by an amount

$$\text{Then } \Delta I = \frac{\Delta V_1 - \Delta V_Z}{R_1} \tag{38}$$

$$\text{Also } \Delta I = \frac{\Delta V_Z}{R_Z} \tag{39}$$

Solving  $\Delta V_1 R_Z - \Delta V_Z R_Z - \Delta V_Z R_1 = 0$

$$\text{Or } \frac{\Delta V_Z}{\Delta V_1} = \frac{R_Z}{R_1 + R_Z} \tag{40}$$

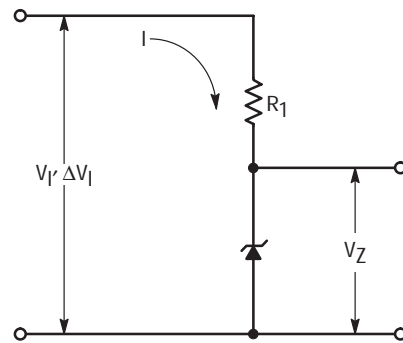
Equation 40 merely states that the change in reference voltage with input tends to zero when the zener impedance tends also to zero, as expected.

The figure of merit equation can be applied to the circuits of Figure 16 and 17 to explain impedance cancellation. The Change Factor equations for each leg and the reference voltage  $V_R$  are:

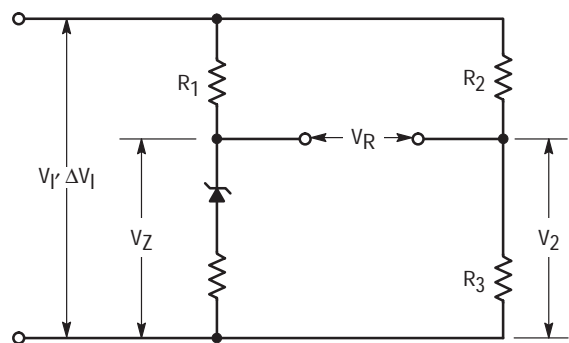
$$CF_{VZ} = \frac{\Delta V_Z}{\Delta V_1} = \frac{R_Z}{R_1 + R_Z} = R_A \tag{41}$$

$$CF_{V2} = \frac{\Delta V_2}{\Delta V_1} = \frac{R_3}{R_2 + R_3} = R_B \tag{42}$$

$$CF_{VR} = \frac{\Delta V_R}{\Delta V_1} = \frac{R_Z}{R_1 + R_Z} = \frac{R_3}{R_2 + R_3} = R_A - R_B \tag{43}$$



**Figure 16. Standard Voltage Regulation Circuit**



**Figure 17. Impedance Cancellation Bridge**

Since the design is to minimize  $CF_{VR}$ ,  $R_B$  can be set equal to  $R_A$ . The Input Regulation Factors are:

$$\gamma_{VZ} = \frac{\Delta V_Z}{\Delta V_I} \left( \frac{V_I}{V_Z} \right) = \frac{1}{1 + \frac{V_Z}{V_I} \left( \frac{R_1}{R_Z} \right)} \quad (44)$$

$$\gamma_{V2} = \frac{\Delta V_2}{\Delta V_I} \left( \frac{V_I}{V_2} \right) = 1 \quad (45)$$

$$\gamma_{VR} = \frac{\Delta V_R}{\Delta V_I} \left( \frac{V_I}{V_R} \right) = \frac{1}{1 + \left( \frac{V_Z}{V_I} \right) \left( \frac{R_1}{R_Z} \right) \left( \frac{1}{1 - \frac{R_B}{R_A}} \right)} \quad (46)$$

It is seen that  $\gamma_{VR}$  can be minimized by setting  $R_B = R_A$ .

Note that it is not necessary to match  $R_3$  to  $R_Z$  and  $R_2$  to  $R_1$ . Thus  $R_3$  and  $R_2$  can be large and hence dissipate low power. This discussion is assuming very light load currents.

# Chapter 7

## ZENER PROTECTIVE CIRCUITS AND TECHNIQUES: BASIC DESIGN CONSIDERATIONS

### INTRODUCTION

The reliability of any system is a function of the ability of the equipment to operate satisfactorily during moderate changes of environment, and to protect itself during otherwise damaging catastrophic changes. The silicon zener diode offers a convenient, simple but effective means of achieving this result. Its precise voltage sensitive breakdown characteristic provides an accurate limiting element in the protective circuit. The extremely high switching speed possible with the zener phenomenon allows the circuit to react faster by orders of magnitude than comparable mechanical and magnetic systems.

By shunting a component, circuit, or system with a zener diode, the applied voltage cannot exceed that of the particular device's breakdown voltage. (See Figure 1.)

A device should be chosen so that its zener voltage is somewhat higher than the nominal operating voltage but lower than the value of voltage that would be damaging if allowed to pass. In order to adequately incorporate the zener diode for circuit protection, the designer must consider several factors in addition to the required zener voltage. The first thing the designer should know is just what transient characteristics can be anticipated, such as magnitude, duration, and the rate of reoccurrence. For short duration transients, it is usually possible to suppress the voltage spike and allow the zener to shunt the transient current away from the load without a circuit shutdown. On the other hand, if the over-voltage condition is for a long duration, the protective circuit may need to be complimented with a disconnect element to protect the zener from damage created by excessive heating. In all cases, the end circuit will have to be designed around the junction temperature limits of the device.

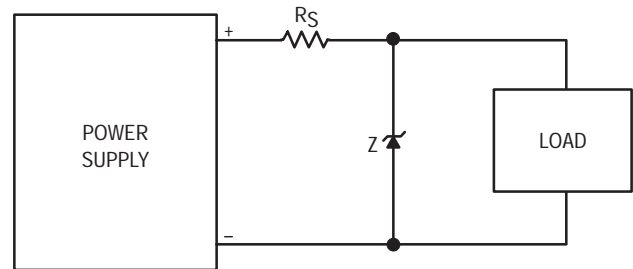
The following sections illustrate the most common zener protective circuits, and will demonstrate the criteria to be followed for an adequate design.

### BASIC PROTECTIVE CIRCUITS FOR SUPPLY TRANSIENTS

The simple zener shunt protection circuit shown in Figure 1 is widely used for supply voltage transient protection where the duration is relatively short. The circuit applies whether the load is an individual component or a complete circuit requiring protection. Whenever the input exceeds the zener voltage, the device avalanches into conduction clamping the load voltage to  $V_Z$ . The total current the diode must carry is determined by the magnitude of the input voltage transient

and the total circuit impedance minus the load current. The worst case occurs when load current is zero and may be expressed as follows:

$$I_{Z(max)} = \frac{V_{I(max)} - V_Z}{R_S} \quad (1)$$



**Figure 1. Basic Shunt Zener Transient Protection Circuit**

The maximum power dissipated by the zener is

$$P_{Z(max)} = I_{Z(max)} V_{Z(max)} = \frac{V_{I(max)} - V_Z}{R_S} V_{Z(max)} \quad (2)$$

Also, more than one device can be used, i.e., a series string, which will reduce the percentage of total power to be dissipated per device by a factor equal to the number of devices in series. The number of diodes required can be found from the following expression:

$$\text{Number} = \frac{P_{Z(max)}}{P_Z(\text{allowable per device})} \quad (3)$$

Any fraction of a zener must be taken as the next highest whole number. This design discussion has been based upon the assumption that the transient is of a single shot, non-recurrent type. For all practical purposes it can be considered non-recurrent if the "off period" between transients is at least four times the thermal time constant of the device. If the "off period" is shorter than this, then the design calculations must include a factor for the duty cycle. This is discussed in detail in Chapter 4. In Chapter 4 there are also some typical curves relating peak power, pulse duration and duty cycle that may be appropriate for some designs.

Obviously, the factor that limits the feasibility of the basic zener shunt protective circuit is the pulse durations "t". As the duration increases, the allowable peak power for a given configuration decreases and will approach a steady state condition.

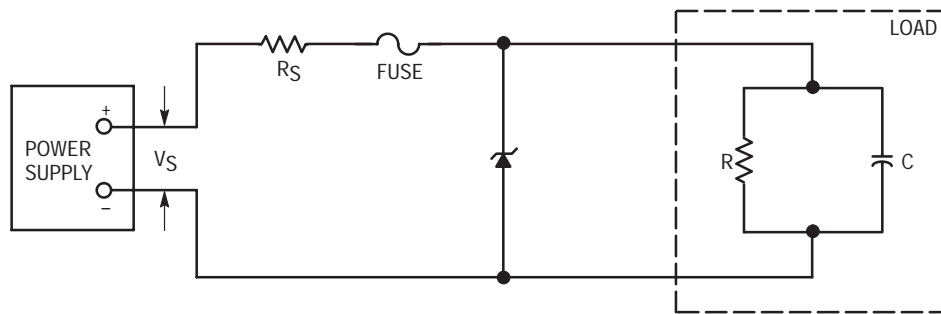


Figure 2. Overvoltage Protection with Zener Diodes and Fuses

When the anticipated transients expected to prevail for a specific situation are of long duration, a basic zener shunt becomes impractical, in such a case the circuit can be improved by using a complementary disconnect element. The most common overload protective element is without a doubt the standard fuse. The common fuse adequately protects circuit components from over-voltage surges, but at the same time must be chosen to eliminate "nuisance fusing" which results when the maximum current rating of the fuse is too close to the normal operational current of the circuit.

### AN EXAMPLE PROBLEM: SELECTING A FUSE-ZENER COMBINATION

Consider the case illustrated in Figure 2. Here the load components are represented by a parallel combination of  $R$  and  $C$ , equivalent to many loads found in practice. The maximum capacitor voltage rating is usually the circuit-voltage limiting factor due to the cost of high voltage capacitors. Consequently, a protective circuit must be designed to prevent voltage surges greater than 1.5 times normal working voltage of the capacitor. It is common, however, for the supply voltage to increase to 135% normal for long periods. Examination of fuse manufacturers' melting time-current curves shows the difficulty of trying to select a fuse which will melt rapidly at overload (within one or two cycles of the supply frequency to prevent capacitor damage), and will not melt when subjected to voltages close to overload for prolonged periods.

By connecting a zener diode of correct voltage ratings across the load as shown, a fuse large enough to withstand normal current increases for long periods may be chosen. The sudden current increase when zener breakdown occurs melts the fuse rapidly and protects the load from large surges. In Figure 3, fuse current was plotted against supply voltage to illustrate the improvement in load protection obtained with zener-fuse combinations. Fuse current "A" would be selected to limit current resulting from voltage surges above 112 V to 90 mA, which would melt the fuse in 100 ms. It is a simple matter, however, to select a fuse which melts in 30 ms at 200 mA but is unaffected by 100 mA currents. The zener connection allows fuse current "B" to be selected, eliminating this design problem and providing a faster, more reliable protective circuit. If the same fuse was

used without the zener diode, a supply voltage of 210 volts would be reached before the fuse would begin to protect the load.

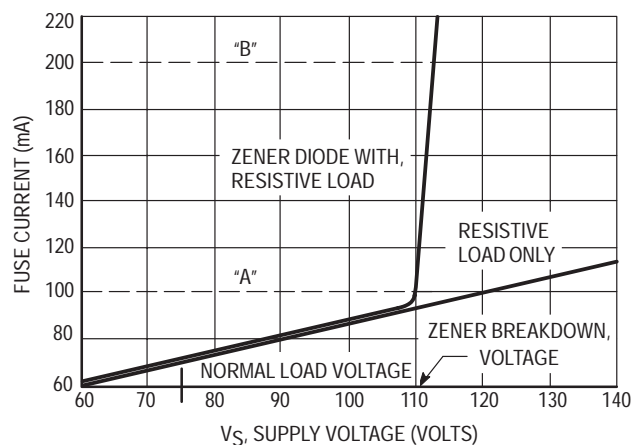


Figure 3. Fuse Current versus Supply Voltage

Selection of the correct power rating of zener diodes to be used for surge protection depends upon the magnitude and duration of anticipated surges. Often in circuits employing both fuses and zener diodes, the limiting surge duration will be the melting time of the fuse. This, in turn, depends on the nature of the load protected and the length of time it will tolerate an overload.

As a first solution to the example problem, consider a zener diode with a nominal breakdown voltage of 110 volts measured at a test current ( $I_{ZT}$ ) of 110 mA. Since the fuse requires about 200 mA to melt and 100 mA are drawn through the load at this voltage, the load voltage will never exceed the zener breakdown voltage on slowly rising inputs. Transients producing currents of approximately 200 mA but of shorter duration than 30 ms will simply be clipped by zener action and diverted from the load. Transients of very high voltage will produce larger currents and, hence, will melt the fuse more rapidly. In the limiting case where transient power might eventually destroy the zener diode, the fuse always melts first because of the slower thermal time constant inherent in the zener diode's larger geometry.

The curves in Figure 4 illustrate the change in zener voltage as a function of changing current for a typical device type.

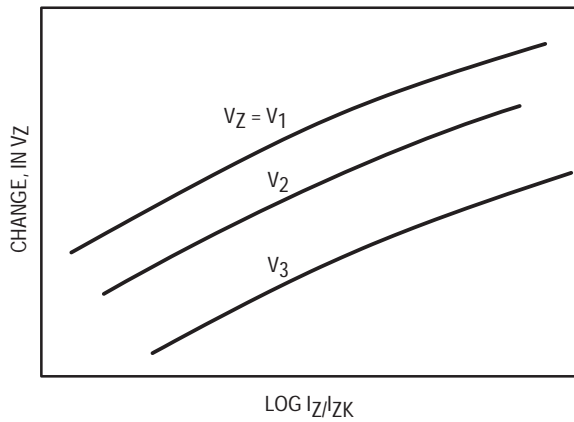


Figure 4. Change in  $V_Z$  for Changes in  $I_Z$

If an actual curve for the device being used is not available, the zener voltage at a specific current above or below the test current may be approximated by equation 4.

Where:  $V = V_Z + Z_{ZT} (I - I_{ZT})$  (4)  
 $V_Z$  = zener voltage at test current  $I_{ZT}$   
 $Z_{ZT}$  = zener impedance at test current  $I_{ZT}$   
 $I_{ZT}$  = test current  
 $V$  = zener voltage at current  $I$

For a given design, the maximum zener voltage to expect for the higher zener current should be determined to make sure the limits of the circuit are met. If the maximum limit is excessive for the original device selection, the next lower voltage rating should be used.

The previous discussion on design consideration for protective circuits incorporating fuses is applicable to any protective element that permanently disconnects the supply when actuated. Rather than a fuse, a non-resetting magnetic circuit breaker could have been used, and the same reasoning would have applied.

**LOAD CURRENT SURGES**

In many actual problems the designer must choose a protective circuit to perform still another task. Not only must the equipment be protected from the voltage surges in the supply, but the supply itself often requires protection from shorts or partial shorts in the load. A direct short in the load is fairly easy to handle, as the drastic current change permits the use of fuses with ratings high enough to avoid problems with supply surges. More common is the partial short, as

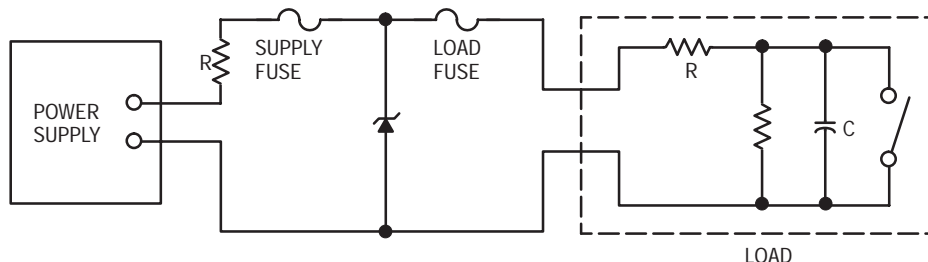


Figure 5. Supply and Load with Zener Diode; Fuse Circuitry

illustrated in Figure 5. If a short circuit occurs in the capacitive section of the load (represented by  $C$ ) the resulting fault current is limited by the resistive section (represented by  $R$ ) to a value which may not be great enough to melt the fuse. The fault current could be sufficient, however, to damage the supply and other components in the load.

The problem is resolved by employing a zener diode to protect against supply surges as described in the previous section, and by selecting a separate fuse to protect from load faults. The load fuse in Figure 5 is chosen close to the normal operating current. Abnormal supply surges do not affect it and equipment operates reliably but with ample protection for the supply against load changes.

**ZENER DIODES AND RECLOSING DISCONNECT ELEMENTS**

An interesting application of zener diodes as overvoltage protectors, which offers the possibility of designing for both long and short duration surges, is shown in Figure 6.

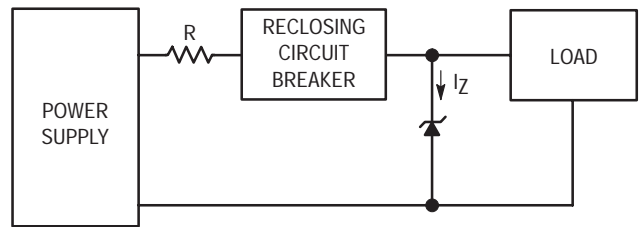
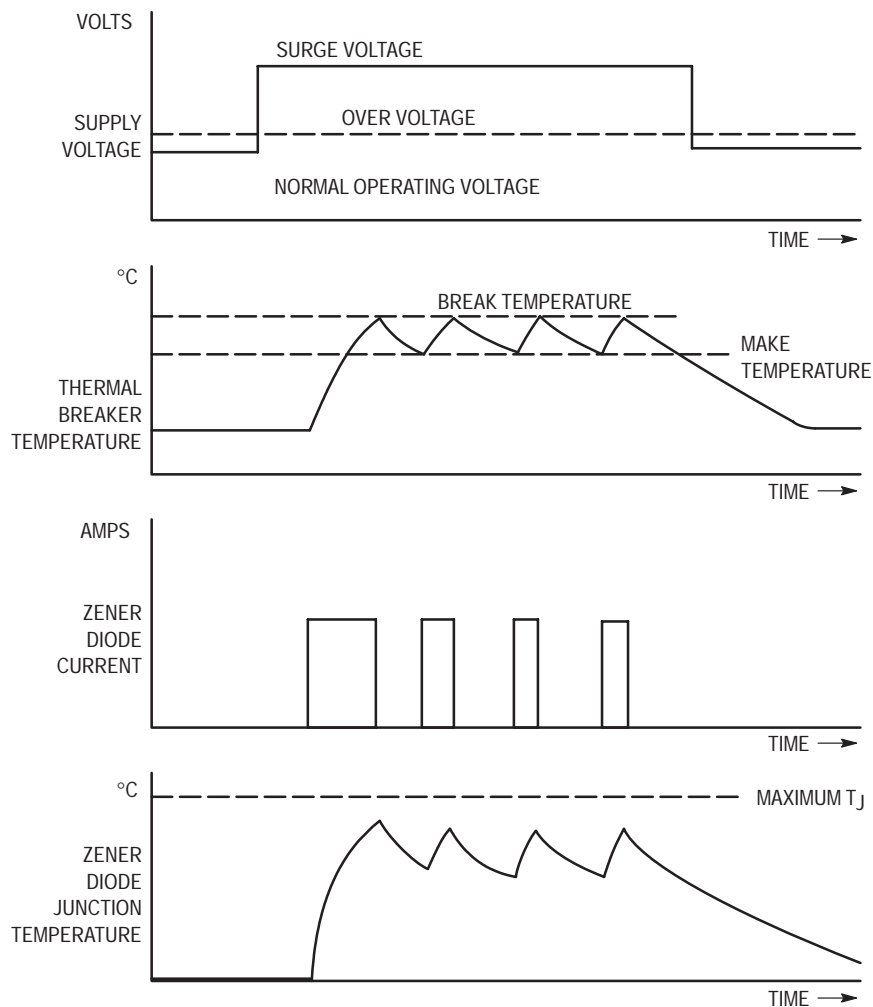


Figure 6. Zener Diode Reclosing Circuit Breaker Protective Circuit

In the event of a voltage overload exceeding a chosen zener voltage, a large current will be drawn through the diode. The reclosing disconnect element opens after an interval determined by its time constant, and the supply is disconnected. After another interval, again depending on the switch characteristics, the supply is reconnected and the voltage "sampled" by the zener. This leads to an "on-off" action which continues until the supply voltage drops below the predetermined limit. At no time can the load voltage or current exceed that set by the zener. The chief advantage in this type of circuit is the elimination of fuse replacement in similar fusing circuits, while providing essentially the same load protection.

It is difficult to define a set design procedure in this case, because of the wide variety of reclosing, magnetic and thermal circuit breakers available. Care should be taken to



**Figure 7. (Typical) Voltage, Current and Temperature Waveforms for a Thermal Breaker**

ensure that the power dissipated in the zener diode during the conduction time of the disconnect element does not exceed its rating. As an example, assume the disconnect element was a thermal breaker switch. The waveforms for a typical over-voltage situation are shown in Figure 7.

It is apparent that the highest zener diode junction temperature is reached during the first conduction period. At this time the thermal breaker is cold and requires the greatest time to reach its break temperature. The breaker then cycles thermally between the make and break temperatures as long as the supply voltage is greater than the zener voltage, as shown in Figure 7.

The zener diode current and junction temperature variation are shown in the last two waveforms of Figure 7. Overvoltage durations longer than the trip time of the thermal breaker do not affect the diode as the supply is disconnected. An overvoltage of much higher level simply causes the thermal breaker to open sooner. In effect, the zener diode rating must

be high enough to ensure that maximum junction temperature is not reached during the longest interval that the thermal switch will be closed.

Manufacturers of thermally operated circuit breakers publish current-time curves for their devices similar to that shown in Figure 8. By estimating the peak supply overvoltage and determining the maximum overvoltage tolerated by the load, an estimation of maximum zener current can be made. The maximum breaker trip time may then be read from Figure 8. (After the initial current surge, the duration of "of" time is determined entirely by the breaker characteristics and will vary widely with manufacture.) The zener diode junction temperature rise during conduction may be calculated now from the thermal time constant of the device and the heatsink used.

Because the reclosing circuit breaker is continually cycling on and off, the zener current takes on the characteristics of a repetitive surge, as can be seen in Figure 7.

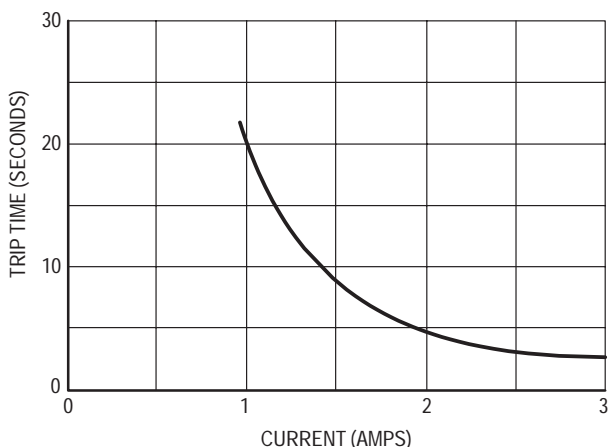


Figure 8. Trip Time versus Current for Thermal Breaker

**TRANSISTOR OVERVOLTAGE PROTECTION**

In many electronic circuits employing transistors, high internal voltages can be developed and, if applied to the transistors, will destroy them. This situation is quite common in transistor circuits that are switching highly inductive loads. A prime example of this would be in transistorized electronic ignition systems such as shown in Figures 9a and 9b.

The zener diode is an important component to assure solid state ignition system reliability. There are two basic methods of using a zener diode to protect an ignition transistor. These are shown in Figures 9a and 9b. In Figure 9b the transistor is protected by a zener diode connected between base and collector and in Figure 9a, the zener is connected between emitter and collector. In both cases the voltage level of the

zener must be selected carefully so that the voltage stress on the transistor is in a region where the safe operating area is adequate for reliable circuit operation.

Figure 10 illustrates "safe" and "unsafe" selection of a zener diode for collector-base protection of a transistor in the ignition coil circuit. It can be seen that the safe operating area of a transistor must be known if an adequate protective zener is to be selected.

The zener diode must be able to take the stress of peak pulse current necessary to clamp the voltage rise across the transistor to a safe value. In a typical case, a 5 watt, 100 volt zener transient suppressor diode is required to operate with an 80 μs peak pulse current of 8 amperes when connected between the collector-emitter of the transistor. The waveform of this pulse current approaches a sine wave in shape (Figure 11). The voltage rise across a typical transient suppressor diode due to this current pulse is shown in Figure 12. This voltage rise of approximately 8 volts indicates an effective zener impedance of approximately 1 ohm. However, a good share of this voltage rise is due to the temperature coefficient and thermal time constant of the zener. The temperature rise of the zener diode junction is indicated by the voltage difference between the rise and fall of the current pulse.

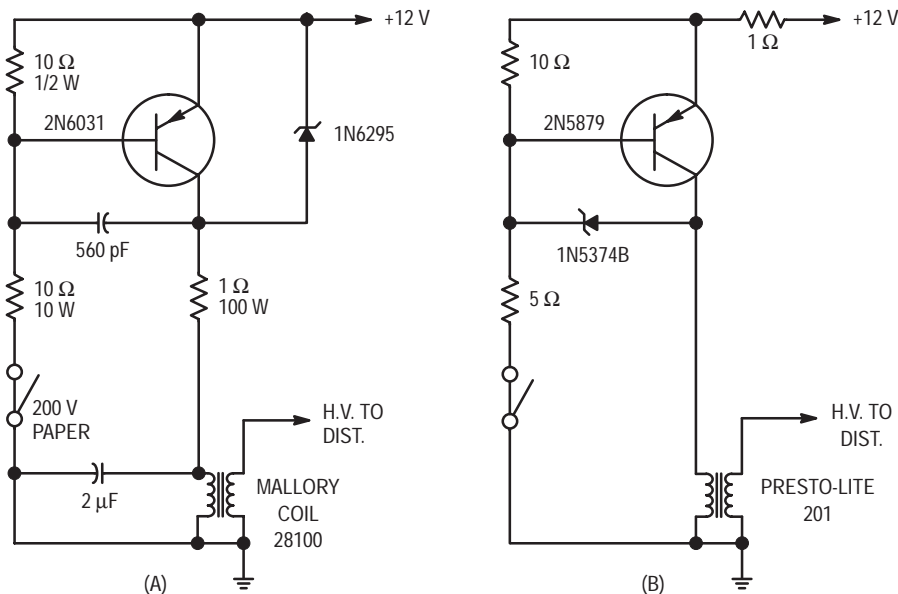


Figure 9. Transistor Ignition Systems with Zener Overvoltage Surge Protection



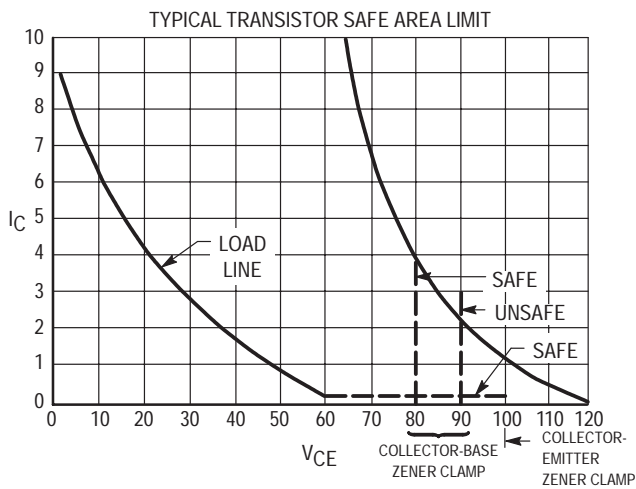


Figure 10. Safe Zener Protection

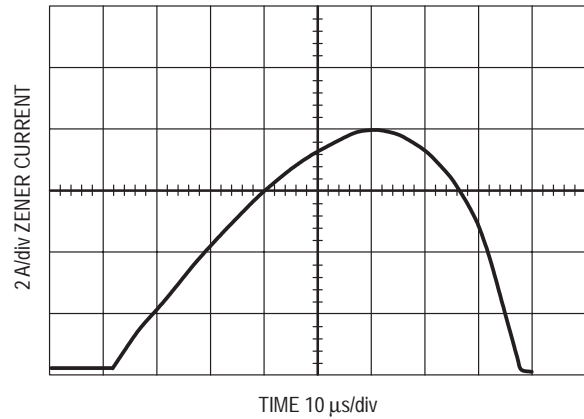


Figure 11. Zener Diode Current Pulse

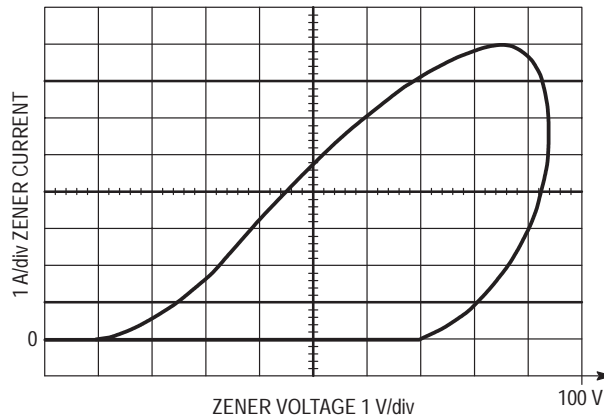


Figure 12. Voltage-Current Representation on 100 V Zener

In order to assure safe operation, the change in zener junction temperature for the peak pulse conditions must be analyzed. In making the calculation, the method described in Chapter 4 should be used, taking into account duty cycle, pulse duration, and pulse magnitude.

When the zener diode is connected between the collector and emitter of the transistor, additional power dissipation will result from the clipping of the ringing voltage of the ignition coil by the forward conduction of the zener diode. This power dissipation by the forward diode current will result in

additional zener voltage rise. It is not uncommon to observe a 15-volt rise above the zener device voltage rating due to temperature coefficient and impedance under these pulse current conditions.

The zener diode should be connected as close as possible to the terminals of the transistor the zener is intended to protect. This insures that induced voltage transients, caused by current changes in long lead lengths, are clamped by the zener and do not appear across the transistor.

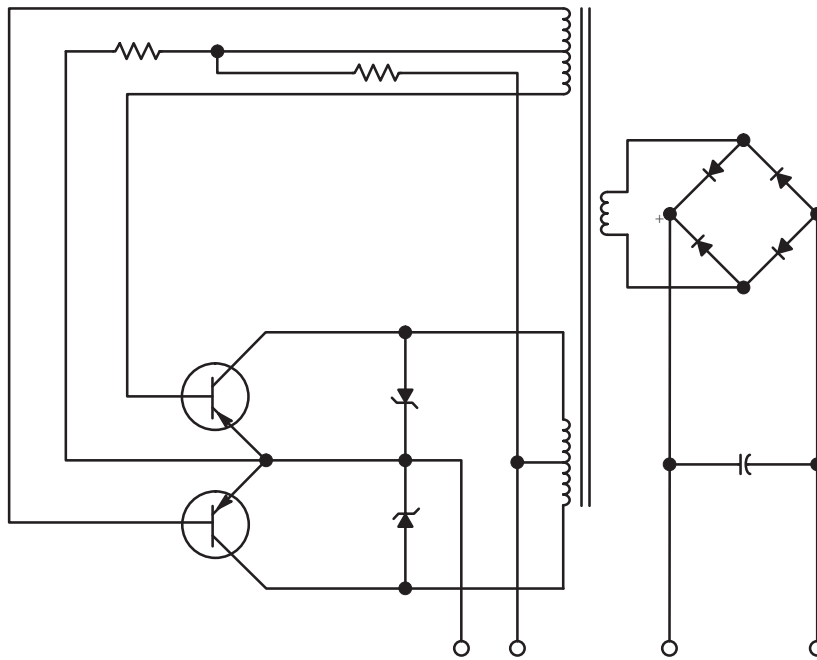


Figure 13. DC-DC Converter with Surge Protecting Diodes

Another example of overvoltage protection of transistor operating in an inductive load switch capacity is illustrated in Figure 13. The DC-DC converter circuit shows a connection from collector to emitter of two zener diodes as collector overvoltage protectors. Without some type of limiting device, large voltage spikes may appear at the collectors, due to the switching transients produced with normal circuit operation. When this spike exceeds the collector breakdown rating of the transistor, transistor life is considerably shortened. The zener diodes shown are chosen with zener breakdowns slightly below transistor breakdown voltage to provide the necessary clipping action. Since the spikes are normally of short duration (0.5 to 5  $\mu$ s) and duty cycle is low, normal chassis mounting provides adequate heatsinking.

### METER PROTECTION

The silicon zener diode can be employed to prevent overloading sensitive meter movements used in low range DC and AC voltmeters, without adversely affecting the meter linearity. The zener diode has the advantage over thermal protective devices of instantaneous action and, of course, will function repeatedly for an indefinite time (as compared to the reset time necessary with thermal devices). While zener protection is presently available for voltages as low as 2.4 volts, forward diode operation can be used for meter protection where the voltage drop is much smaller. A typical protective circuit is illustrated in Figure 14. Here the meter movement requires 100  $\mu$ Amps for full scale deflection and has 940 ohms resistance. For use in a voltmeter to measure

25 V, approximately 249 thousand ohms are required in series.

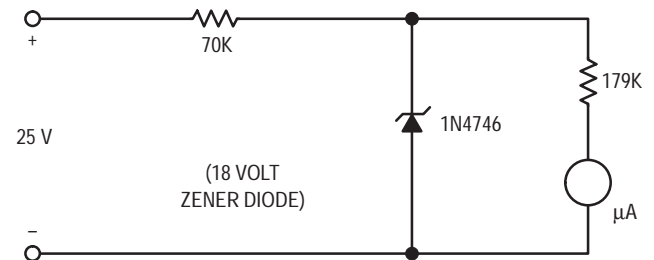
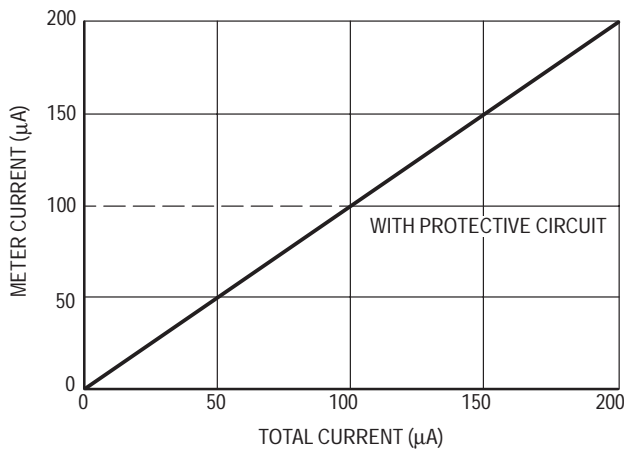


Figure 14. Meter Protection with Zener Diode

The protection provided by the addition of an 18 volt zener is illustrated in Figure 15. With an applied voltage of 25 volts, the 100  $\mu$ Amps current in the circuit produces a drop of 17.9 volts across the series resistance of 179 thousand ohms. A further increase in voltage causes the zener diode to conduct, and the overload current is shunted away from the meter. Since Motorola zener diodes have zener voltages specified within 5 and 10%, a safe design may always be made with little sacrifice in meter linearity by assuming the lowest breakdown voltage within the tolerance. The shunting effect on the meter of the reverse biased diode is generally negligible below breakdown voltage (on the order of 0.5° full scale). For very precise work, the zener diode breakdown voltage must be accurately known and the design equations solved for the correct resistance values.



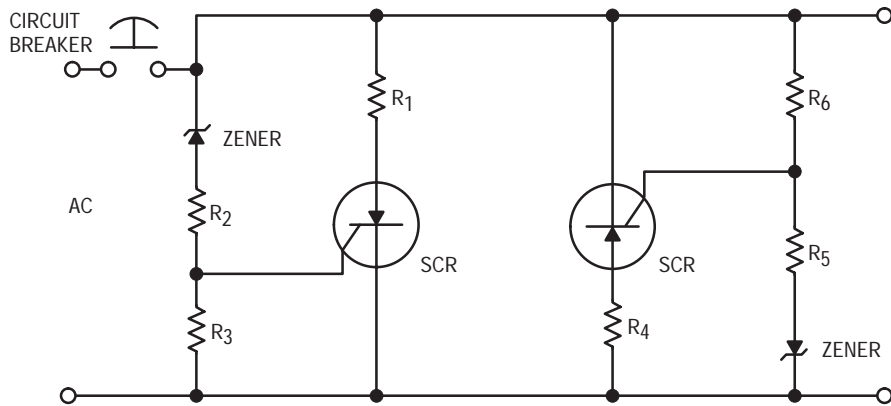
**Figure 15. Meter Protection with Zener Diodes**

**ZENER DIODES USED WITH SCRS FOR CIRCUIT PROTECTION**

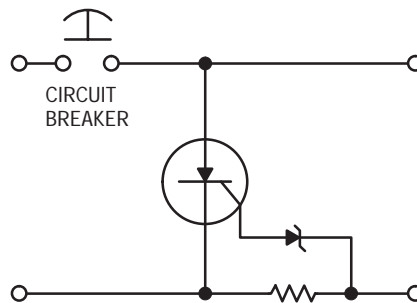
An interesting aspect of circuit protection incorporating the reliable zener diode is the protective circuits shown in Figures 16 and 17.

In a system that is handling large amounts of power, it may become impractical to employ standard zener shunt protection because of the large current it would be required to carry. The SCR crowbar technique shown in Figure 16 can be effectively used in these situations. The zener diode is still the transient detection component, but it is only required to carry the gate current for SCR turn on, and the SCR will carry the bulk of the shunt current. Whenever the incoming voltage exceeds the zener voltage, it avalanches, supplying gate drive to the SCR which, when fired, causes a current demand that will trip the circuit breaker. The resistors shown are for current limiting so that the SCR and zener ratings are not exceeded.

The circuit of Figure 17 is designed to disconnect the supply in the event a specified load current is exceeded. This is done by means of a series sense resistor and a compatible zener to turn the shunt SCR on. When the voltage across the series resistor, which is a function of the load current, becomes sufficient to break over the zener, the SCR is fired, causing the circuit breaker to trip.



**Figure 16. SCR Crowbar Over-Voltage Protection Circuit for AC Circuit Operation**



**Figure 17. SCR Longterm Current Overload Protection**

### ZENER TRANSIENT SUPPRESSORS

The transient suppressor is used as a shunt element in exactly the same manner as a conventional zener. It offers the same advantages such as low insertion loss, immediate recovery after operation, a clamping factor approaching unity, protection against fast rising transients, and simple circuitry. The primary difference is that the transient suppressor extends these advantages to higher power levels.

Even in the event of transients with power contents far in excess of the capacity of the zeners, protection is still provided the load. When overloaded to failure, the zener will approximate a short. The resulting heavy drain will aid in opening the fuse or circuit breaker protecting the load against excess current. Thus, even if the suppressor is destroyed, it still protects the load.

The design of the suppressor-fuse combination for the required level of protection follows the techniques for conventional zeners discussed earlier in this chapter.

### TRANSIENT SUPPRESSION CHARACTERISTICS

Zener diodes, being nearly ideal clippers (that is, they exhibit close to an infinite impedance below the clipping level and close to a short circuit above the clipping level), are often used to suppress transients. In this type of application, it is important to know the power capability of the zener for short pulse durations, since they are intolerant of excessive stress.

Some Motorola data sheets such as the ones for devices shown in Table 1 contain short pulse surge capability. However, there are many data sheets that do not contain this data and Figure 18 is presented here to supplement this information.

Table 1. Transient Suppressor Diodes

Series Numbers	Steady State Power	Package	Description
1N4728A	1 W	DO-41	Double Slug Glass
1N6267A	5 W	Case 41A	Axial Lead Plastic
1N5333B	5 W	Case 102	Surmetic 40
1N746A/957B/ 4370A	500 mW	DO-35	Double Slug Glass
1N5221B	500 mW	DO-35	Double Slug Glass

Some data sheets have surge information which differs slightly from the data shown in Figure 18. A variety of reasons exist for this:

1. The surge data may be presented in terms of actual surge power instead of nominal power.
2. Product improvements have occurred since the data sheet was published.

3. Large dice are used, or special tests are imposed on the product to guarantee higher ratings than those shown in Figure 18.
4. The specifications may be based on a JEDEC registration or part number of another manufacturer.

The data of Figure 18 applies for non-repetitive conditions and at a lead temperature of 25°C. If the duty cycle increases, the peak power must be reduced as indicated by the curves of Figure 19. Average power must be derated as the lead or ambient temperature rises above 25°C. The average power derating curve normally given on data sheets may be normalized and used for this purpose.

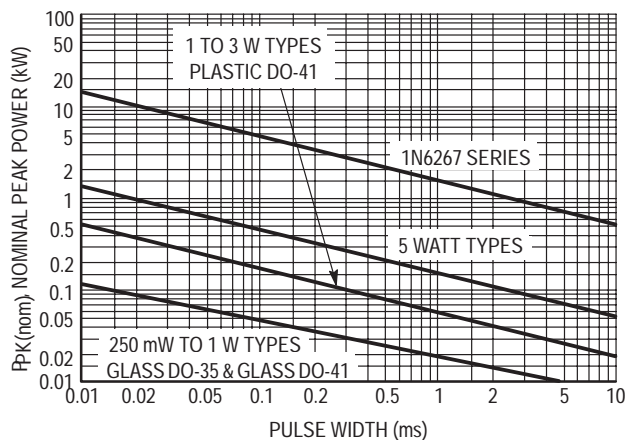


Figure 18. Peak Power Ratings of Zener Diodes

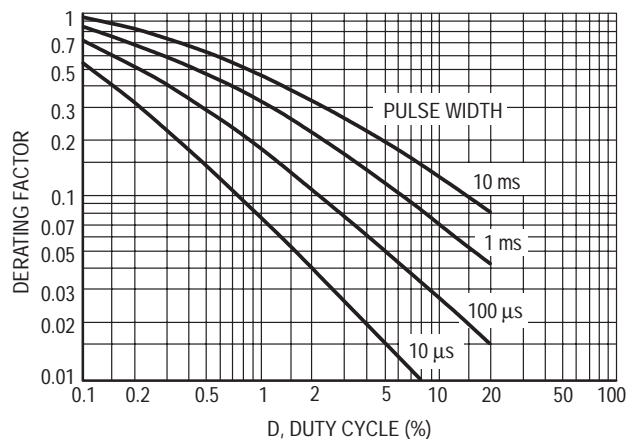


Figure 19. Typical Derating Factor for Duty Cycle

When it is necessary to use a zener close to surge ratings, and a standard part having guaranteed surge limits is not suitable, a special part number may be created having a surge limit as part of the specification. Contact your nearest Motorola OEM sales office for capability, price, delivery, and minimum order quantities.

### MATHEMATICAL MODEL

Since the power shown on the curves is not the actual transient power measured, but is the product of the peak current measured and the nominal zener voltage measured at the current used for voltage classification, the peak current can be calculated from:

$$I_Z(\text{PK}) = \frac{P(\text{PK})}{V_Z(\text{nom})} \quad (5)$$

The peak voltage at peak current can be calculated from:

$$V_Z(\text{PK}) = F_C \times V_Z(\text{nom}) \quad (6)$$

where  $F_C$  is the clamping factor. The clamping factor is approximately 1.20 for all zener diodes when operated at their pulse power limits. For example, a 5 watt, 20 volt zener can be expected to show a peak voltage of 24 volts regardless of whether it is handling 450 watts for 0.1 ms or 50 watts for 10 ms. This occurs because the voltage is a function of junction temperature and IR drop. Heating of the junction is more severe at the longer pulse width, causing a higher voltage component due to temperature which is roughly offset by the smaller IR voltage component.

For modeling purposes, an approximation of the zener resistance is needed. It is obtained from:

$$R_Z(\text{nom}) = \frac{V_Z(\text{nom})(F_C - 1)}{P_{\text{PK}}(\text{nom}) / V_Z(\text{nom})} \quad (7)$$

The value is approximate because both the clamping factor and the actual resistance are a function of temperature.

### CIRCUIT CONSIDERATIONS

It is important that as much impedance as circuit constraints allow be placed in series with the zener diode and the components to be protected. The result will be a

lower clipping voltage and less zener stress. A capacitor in parallel with the zener is also effective in reducing the stress imposed by very short duration transients.

To illustrate use of the data, a common application will be analyzed. The transistor in Figure 20 drives a 50 mH solenoid which requires 5 amperes of current. Without some means of clamping the voltage from the inductor when the transistor turns off, it could be destroyed.

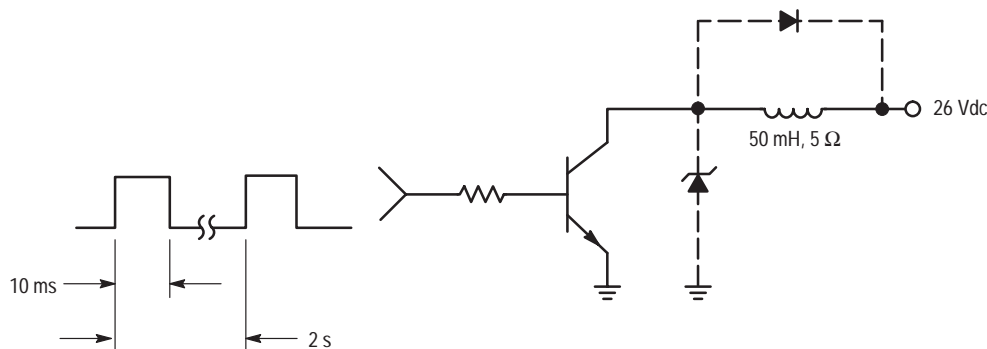
The means most often used to solve the problem is to connect an ordinary rectifier diode across the coil; however, this technique may keep the current circulating through the coil for too long a time. Faster switching is achieved by allowing the voltage to rise to a level above the supply before being clamped. The voltage rating of the transistor is 60 V, indicating that approximately a 50 volt zener will be required.

The peak current will equal the on-state transistor current (5 amperes) and will decay exponentially as determined by the coil L/R time constant (neglecting the zener impedance). A rectangular pulse of width L/R (0.01 s) and amplitude of  $I_{\text{PK}}$  (5 A) contains the same energy and may be used to select a zener diode. The nominal zener power rating therefore must exceed  $(5 \text{ A} \times 50) = 250$  watts at 10 ms and a duty cycle of  $0.01/2 = 0.5\%$ . From Figure 19, the duty cycle factor is 0.62 making the single pulse power rating required equal to  $250/0.62 = 403$  watts. From Figure 18, one of the 1N6267 series zeners has the required capability. The 1N6287 is specified nominally at 47 volts and should prove satisfactory.

Although this series has specified maximum voltage limits, equation 7 will be used to determine the maximum zener voltage in order to demonstrate its use.

$$R_Z = \frac{47(1.20 - 1)}{500/47} = \frac{9.4}{10.64} = 0.9 \Omega$$

At 5 amperes, the peak voltage will be 4.5 volts above nominal or 51.5 volts total which is safely below the 60 volt transistor rating.



USED TO SELECT A ZENER DIODE HAVING THE PROPER VOLTAGE AND POWER CAPABILITY TO PROTECT THE TRANSISTOR

Figure 20. Circuit Example

# Chapter 8

## ZENER VOLTAGE SENSING CIRCUITS AND APPLICATIONS

### BASIC CONCEPTS OF VOLTAGE SENSING

Numerous electronic circuits require a signal or voltage level to be sensed for circuit actuation, function control, or circuit protection. The circuit may alter its mode of operation whenever an interdependent signal reaches a particular magnitude (either higher or lower than a specified value). These sensing functions may be accomplished by incorporating a voltage dependent device in the system creating a switching action that controls the overall operation of the circuit.

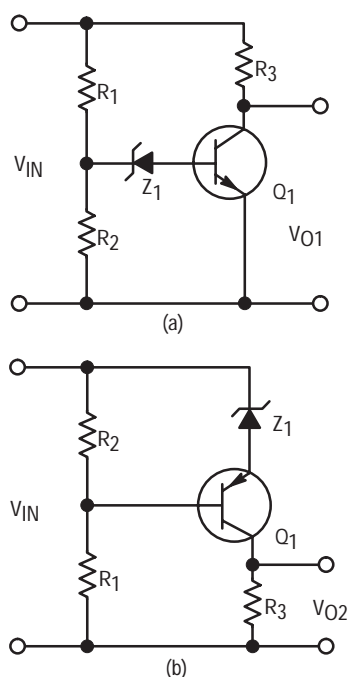
The zener diode is ideally suited for most sensing applications because of its voltage dependent characteristics. The following sections are some of the more common applications and techniques that utilize the zener in a voltage sensing capacity.

### TRANSISTOR-ZENER SENSING CIRCUITS

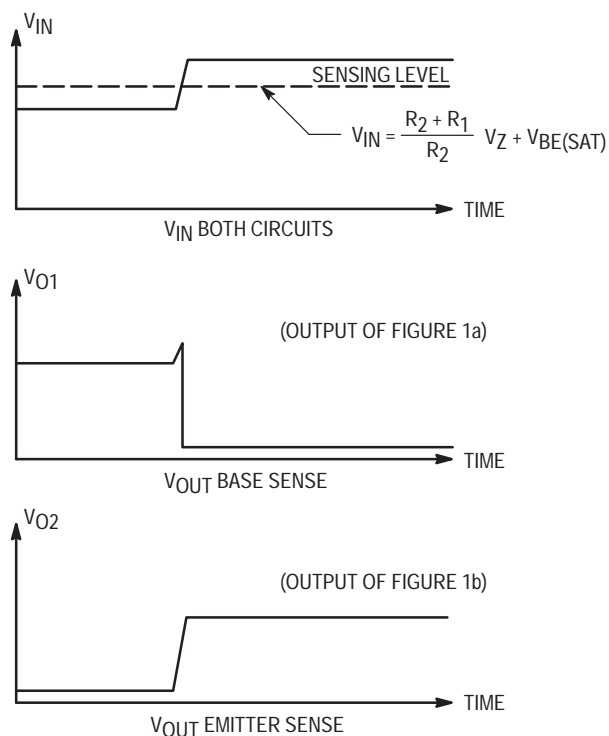
The zener diode probably finds its greatest use in sensing applications in conjunction with other semiconductor devices. Two basic widely used techniques are illustrated in Figures 1a and 1b.

In both of these circuits the output is a function of the input voltage level. As the input goes from low to high, the output will switch from either high to low (base sense circuit) or low to high (emitter sense circuit), (see Figure 2).

The base sense circuit of Figure 1a operates as follows: When the input voltage is low, the voltage dropped across  $R_2$  is not sufficient to bias the zener diode and base emitter junction into conduction, therefore, the transistor will not conduct. This causes a high voltage from collector to emitter. When the input becomes high, the zener is biased into conduction, the transistor turns on, and the collector to emitter voltage, which is the output, drops to a low value.



**Figure 1. Basic Transistor-Zener Diode Sensing Circuits**



**Figure 2. Outputs of Transistor-Zener Voltage Sensing Circuits**

The emitter sense circuit of Figure 1b operates as follows: When the input is low the voltage drop across  $R_3$  (the output) is negligible. As the input voltage increases the voltage drop across  $R_2$  biases the zener into conduction and forward biases the base-emitter junction. A large voltage drop across  $R_3$  (the output voltage) is equal to the product of the collector current times the resistance,  $R_3$ . The following relationships indicate the basic operating conditions for the circuits in Figure 1.

Circuit	Output
1a	$\begin{cases} \text{High} \\ V_{OUT} = V_{IN} - I_C R_3 \cong V_{IN} \\ \text{Low} \\ V_{OUT} = V_{IN} - I_C R_3 = V_{CE(sat)} \end{cases}$
1b	$\begin{cases} \text{Low} \\ V_{OUT} = V_{IN} - V_Z - V_{CE(off)} = I_C R_3 \\ \text{High} \\ V_{OUT} = V_{IN} - V_{CE(sat)} = I_C R_3 \end{cases}$

In addition, the basic circuits of Figure 1 can be rearranged to provide inverse output.

### AUTOMOTIVE ALTERNATOR VOLTAGE REGULATOR

Electromechanical devices have been employed for many years as voltage regulators, however, the regulation setting

of these devices tend to change and have mechanical contact problems. A solid state regulator that controls the charge rate by sensing the battery voltage is inherently more accurate and reliable. A schematic of a simplified solid state voltage regulator is shown in Figure 3.

The purpose of an alternator regulator is to control the battery charging current from the alternator. The charge level of the battery is proportional to the battery voltage level. Consequently, the regulator must monitor the battery voltage level allowing charging current to pass when the battery voltage is low. When the battery has attained the proper charge the charging current is switched off. In the case of the solid state regulator of Figure 3, the charging current is controlled by switching the alternator field current on and off with a series transistor switch,  $Q_2$ . The switching action of  $Q_2$  is controlled by a voltage sensing circuit that is identical to the base sense circuit of Figure 1a. When under-charged, the zener  $Z_1$  does not conduct keeping  $Q_1$  off. The collector-emitter voltage of  $Q_1$  supplies a forward bias to the base-emitter of  $Q_2$ , turning it on. With  $Q_2$  turned on, the alternator field is energized allowing a charging current to be delivered to the battery. When the battery attains a proper charge level, the zener conducts causing  $Q_1$  to turn on, and effectively shorting out the base-emitter junction of  $Q_2$ . This short circuit cuts off  $Q_2$ , turns off the current flowing in the field coil which consequently, reduces the output of the alternator. Diode  $D_1$  acts as a field suppressor preventing the build up of a high induced voltage across the coil when the coil current is interrupted.

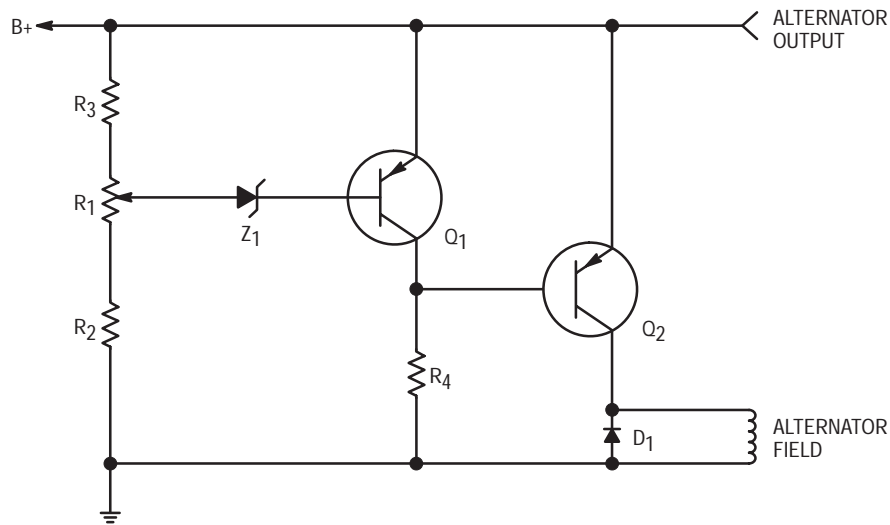


Figure 3. Simplified Solid State Voltage Regulator

In actual operation, this switching action occurs many times each second, depending upon the current drain from the battery. The battery charge, therefore, remains essentially constant and at the maximum value for optimum operation.

A schematic of a complete alternator voltage regulator is shown in Figure 4.

It is also possible to perform the alternator regulation function with the sensing element in the emitter of the control transistor as shown in Figure 5.

In this configuration, the sensing circuit is composed of  $Z_1$  and  $Q_1$  with biasing components. It is similar to the sensing circuit shown in Figure 1b. The potentiometer  $R_1$  adjusts the conduction point of  $Q_1$  establishing the proper charge level. When the battery has reached the desired level,  $Q_1$  begins to conduct. This draws  $Q_2$  into conduction, and therefore shorts off  $Q_3$  which is supplying power to the alternator field. This type of regulator offers greater sensitivity with an increase in cost.

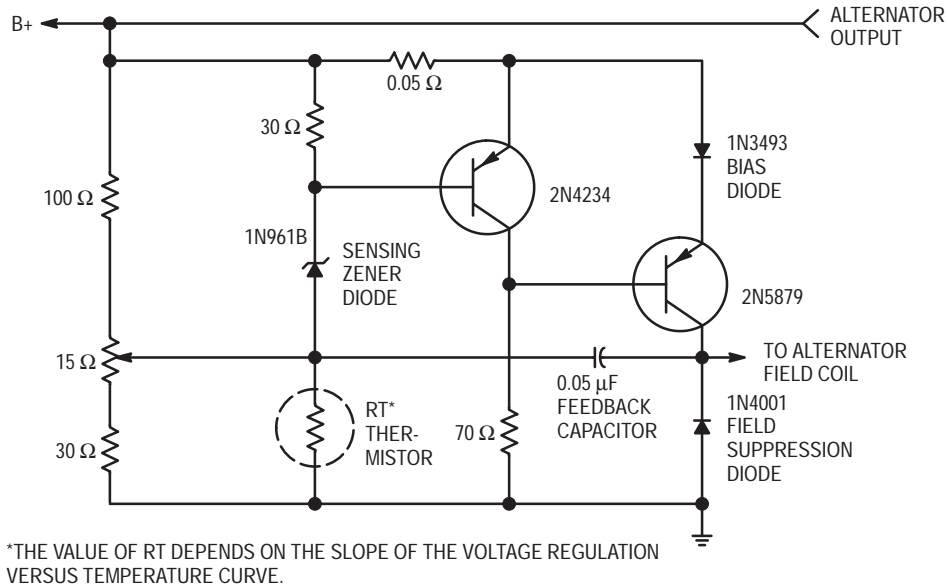


Figure 4. Complete Solid State Alternator Voltage Regulator

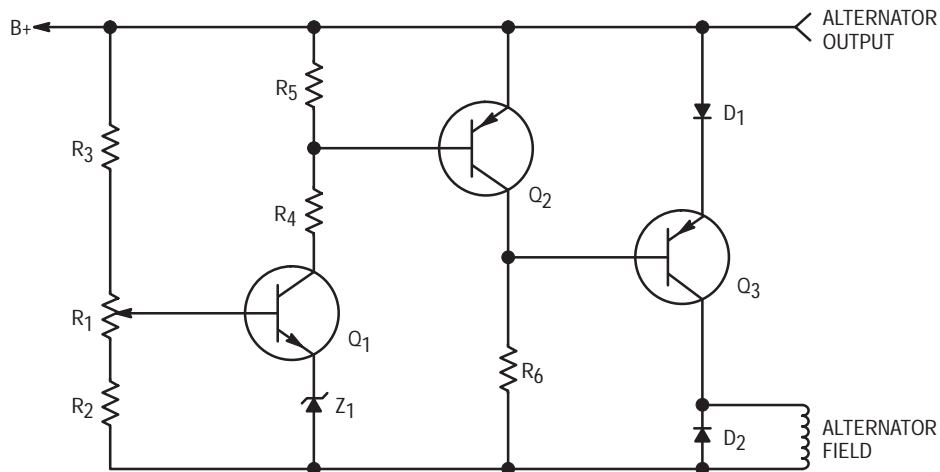


Figure 5. Alternator Regulator with Emitter Sensor



**UNIUNCTION-ZENER SENSE CIRCUITS**

Unijunction transistor oscillator circuits can be made GO-NO GO voltage sensitive by incorporating a zener diode clamp. The UJT operates on the criterion: under proper biasing conditions the emitter-base one junction will breakover when the emitter voltage reaches a specific value given by the equation:

$$V_p = \eta V_{BB} + V_D \quad (1)$$

where:

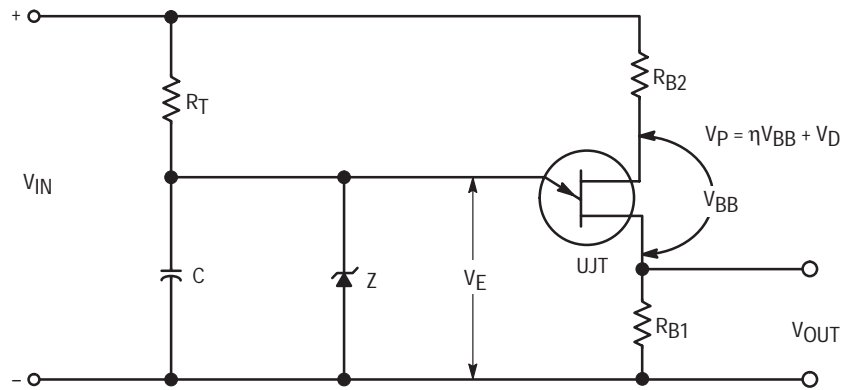
- $V_p$  = peak point emitter voltage
- $\eta$  = intrinsic stand-off ratio for the device
- $V_{BB}$  = interbase voltage, from base two to base one
- $V_D$  = emitter to base one diode forward junction drop.

Obviously, if we provide a voltage clamp in the circuit such that the conditions of equation 1 are met only with restriction on the input, the circuit becomes voltage sensitive. There are two basic techniques used in clamping UJT relaxation oscillators. They are shown in Figure 6 and Figure 7.

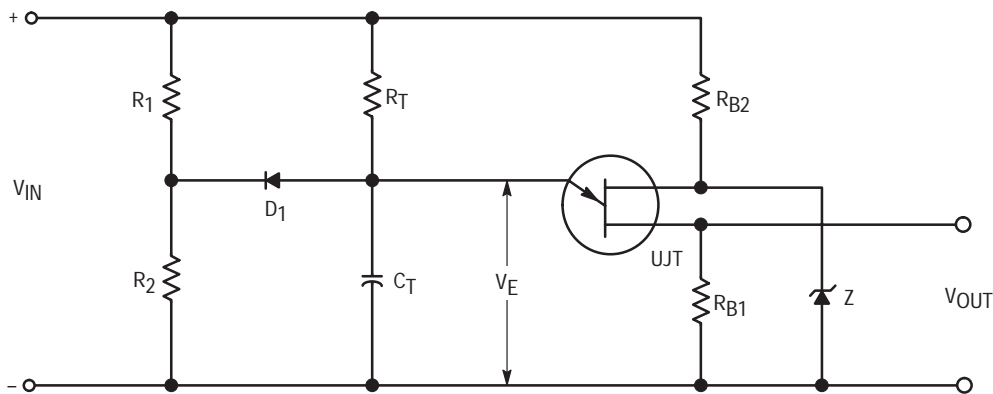
The circuit in Figure 6 is that of a clamped emitter type. As long as the input voltage  $V_{IN}$  is low enough so that  $V_p$

does not exceed the Zener voltage  $V_Z$ , the circuit will generate output pulses. At some given point, the required  $V_p$  for triggering will exceed  $V_Z$ . Since  $V_p$  is clamped at  $V_Z$ , the circuit will not oscillate. This, in essence, means the circuit is GO as long as  $V_{IN}$  is below a certain level, and NO GO above the critical clamp point.

The circuit of Figure 7, is a clamped base UJT oscillator. In this circuit  $V_{BB}$  is clamped at a voltage  $V_Z$  and the emitter tied to a voltage dividing network by a diode  $D_1$ . When the input voltage is low, the voltage drop across  $R_2$  is less than  $V_p$ . The forward biased diode holds the emitter below the trigger level. As the input increases, the  $R_2$  voltage drop approaches  $V_p$ . The diode  $D_1$  becomes reversed biased and, the UJT triggers. This phenomenon establishes the operating criterion that the circuit is NO GO at a low input and GO at an input higher than the clamp voltage. Therefore, the circuits in Figures 6 and 7 are both input voltage sensitive, but have opposite input requirements for a GO condition. To illustrate the usefulness of the clamped UJT relaxation oscillators, the following two sections show them being used in practical applications.



**Figure 6. UJT Oscillator, GO — NO GO Output, GO for Low  $V_{IN}$  — NO GO for High  $V_{IN}$**



**Figure 7. UJT — NO GO Output, NO GO for Low  $V_{IN}$  — GO for High  $V_{IN}$**

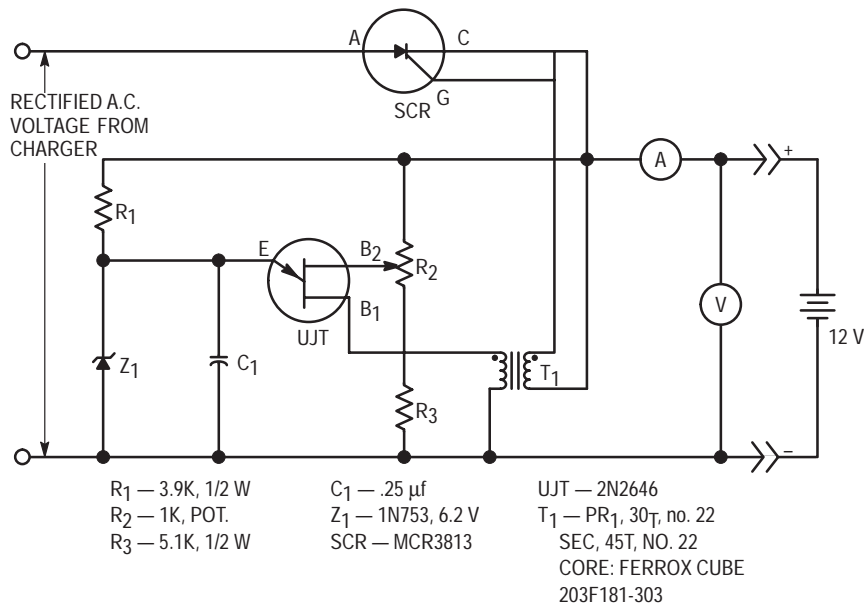
**BATTERY VOLTAGE SENSITIVE SCR CHARGER**

A clamped emitter unijunction sensing circuit of the type shown in Figure 6 makes a very good battery charger (illustrated in Figure 8). This circuit will not operate until the battery to be charged is properly connected to the charger. The battery voltage controls the charger and will dictate its operation. When the battery is properly charged, the charger will cease operation.

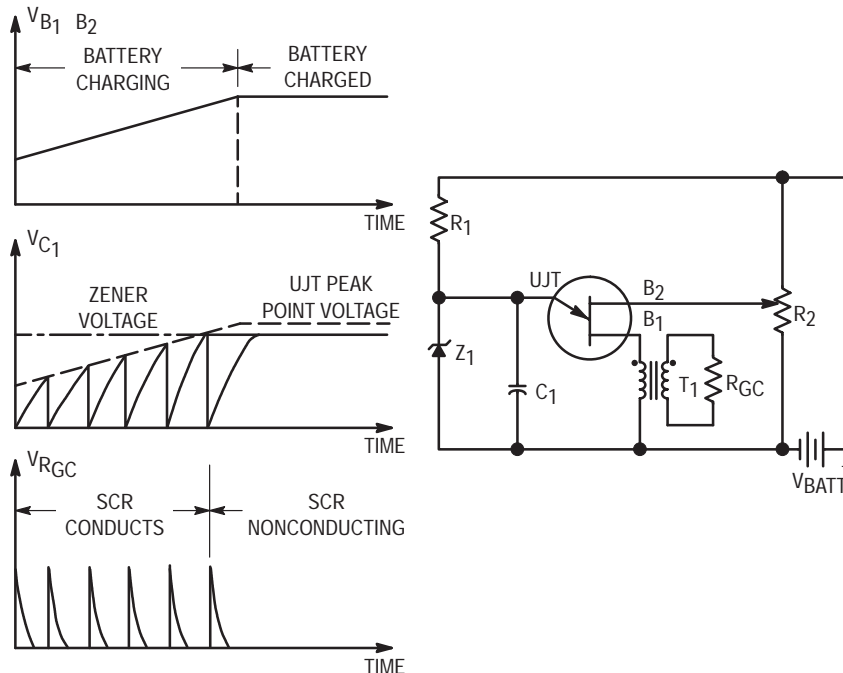
The battery charging current is obtained through the controlled rectifier. Triggering pulses for the controlled rectifier are generated by unijunction transistor relaxation oscillator (Figure 9). This oscillator is activated when the battery voltage is low.

While operating, the oscillator will produce pulses in the pulse transformer connected across the resistance,  $R_{GC}$  ( $R_{GC}$  represents the gate-to-cathode resistance of the controlled rectifier), at a frequency determined by the resistance, capacitance, R.C. time delay circuit.

Since the base-to-base voltage on the unijunction transistor is derived from the charging battery, it will increase as the battery charges. The increase in base-to-base voltage of the unijunction transistor causes its peak point voltage (switching voltage) to increase. These waveforms are sketched in Figure 9 (this voltage increase will tend to change the pulse repetition rate, but this is not important).



**Figure 8. 12 Volt Battery Charger Control**



**Figure 9. UJT Relaxation Oscillator Operation**

When the peak point voltage (switching voltage) of the unijunction transistor exceeds the breakdown voltage of the Zener diode, Z<sub>1</sub>, connected across the delay circuit capacitor, C<sub>1</sub>, the unijunction transistor ceases to oscillate. If the relaxation oscillator does not operate, the controlled rectifier will not receive trigger pulses and will not conduct. This indicates that the battery has attained its desired charge as set by R<sub>2</sub>.

The unijunction cannot oscillate unless a voltage somewhere between 3 volts and the cutoff setting is present at the output terminals with polarity as indicated. Therefore, the SCR cannot conduct under conditions of a short circuit, an open circuit, or a reverse polarity connection to the battery.

### ALTERNATOR REGULATOR FOR PERMANENT MAGNET FIELD

In alternator circuits such as those of an outboard engine, the field may be composed of a permanent magnet. This increases the problem of regulating the output by limiting the control function to opening or shorting the output. Because of the high reactance source of most alternators, opening the output circuit will generally stress the bridge rectifiers to a very high voltage level. It is, therefore, apparent that the best control function would be shorting the output of the alternator for regulation of the charge to the battery.

Figure 10 shows a permanent magnet alternator regulator designed to regulate a 15 ampere output. The two SCRs are connected on the ac side of the bridge, and short out the alternator when triggered by the unijunction voltage sensitive triggering circuit. The sensing circuit is of the type shown in Figure 7. The shorted output does not appreciably increase the maximum output current level.

A single SCR could be designed into the dc side of the bridge. However, the rapid turn-off requirement of this type of circuit at high alternator speeds makes this circuit impractical.

The unijunction circuit in Figure 10 will not oscillate until the input voltage level reaches the voltage determined by the intrinsic standoff ratio. The adjustable voltage divider will calibrate the circuit. The series diode in the voltage divider circuit will compensate for the emitter-base-one diode temperature change, consequently, temperature compensation is necessary only for the zener diode temperature changes.

Due to the delay in charging the unijunction capacitor, when the battery is disconnected the alternator voltage will produce high stress voltage on all components before the SCRs will be fired. The 1N971B Zener was included in the circuit to provide a trigger pulse to the SCRs as soon as the alternator output voltage level approaches 30 volts.

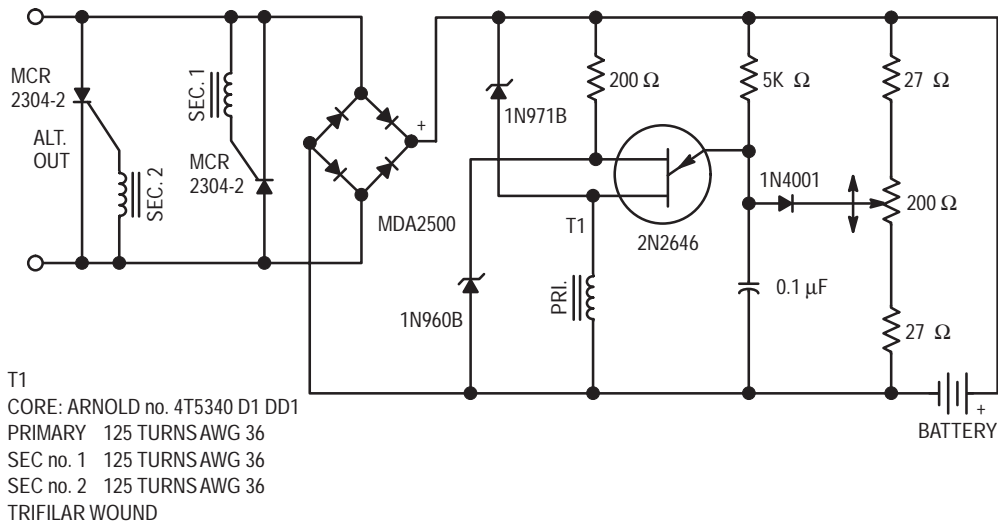


Figure 10. Permanent Magnet Field Alternator Regulator

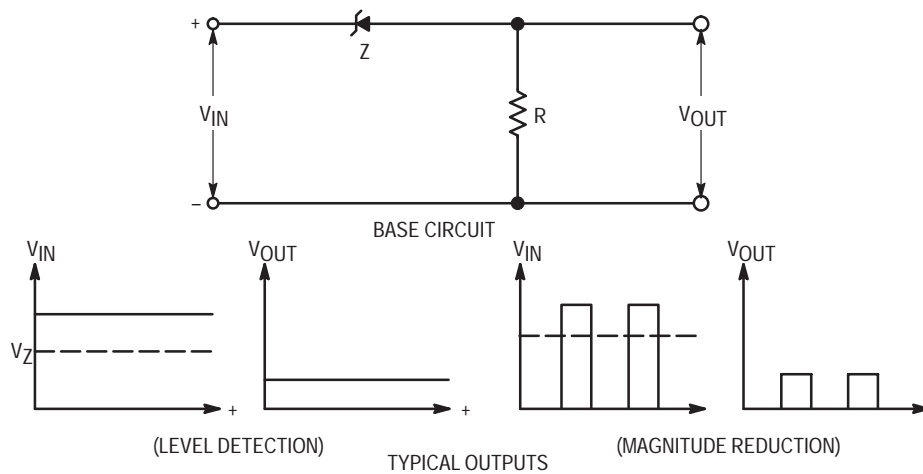


Figure 11. Zener-Resistor Voltage Sensitive Circuit

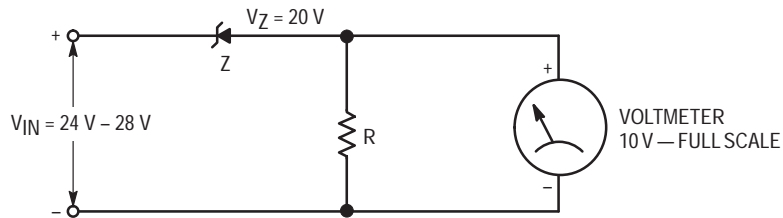


Figure 12. Improving Meter Resolution

**ZENER-RESISTOR VOLTAGE SENSING**

A simple but useful sense circuit can be made from just a Zener diode and resistor such as shown in Figure 11.

Whenever the applied signal exceeds the specific Zener voltage  $V_Z$ , the difference appears across the dropping resistor R. This level dependent differential voltage can be used for level detection, magnitude reduction, wave shaping, etc. An illustrative application of the simple series Zener sensor is shown in Figure 12, where the resistor drop is monitored with a voltmeter.

If, for example, the input is variable from 24 to 28 volts, a 30 voltmeter would normally be required. Unfortunately, a 4 volt range of values on a 30 volt scale utilizes only 13.3% of the meter movement — greatly limiting the accuracy with

which the meter can be read. By employing a 20 volt zener, one can use a 10 voltmeter instead of the 30 volt unit, thereby utilizing 40% of the meter movement instead of 13.3% with a corresponding increase in accuracy and readability. For ultimate accuracy a 24 volt zener could be combined with a 5 voltmeter. This combination would have the disadvantage of providing little room for voltage fluctuations, however.

In Figure 13, a number of sequentially higher-voltage Zener sense circuits are cascaded to actuate transistor switches. As each goes into avalanche its respective switching transistor is turned on, actuating the indicator light for that particular voltage level. This technique can be expanded and modified to use the zener sensors to actuate some form of logic system.

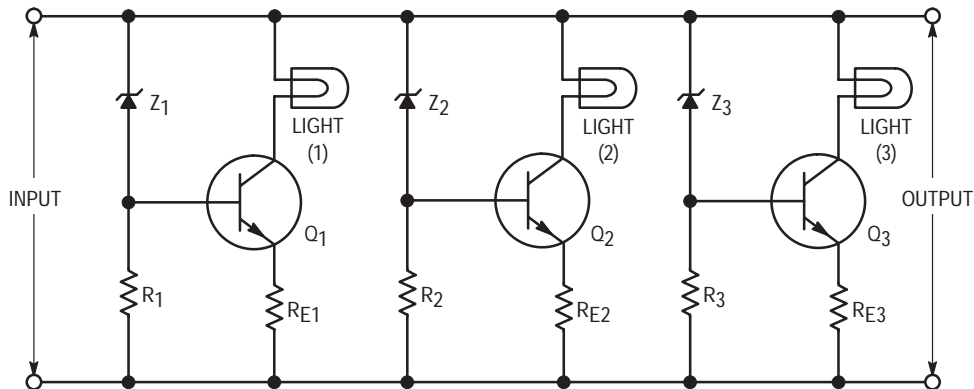


Figure 13. Sequential Voltage Level Indicator

# Chapter 9

## MISCELLANEOUS APPLICATIONS OF ZENER TYPE DEVICES

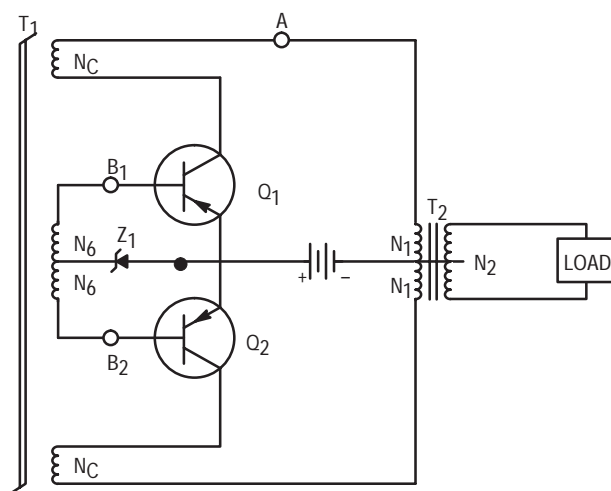
### INTRODUCTION

Many of the commonly used applications of zener diodes have been illustrated in some depth in the preceding chapters. This chapter shows how a zener diode may be used in some rarer applications such as voltage translators, to provide constant current, wave shaping, frequency control and synchronized SCR triggers.

The circuits used in this chapter are not intended as finished designs since only a few component values are given. The intent is to show some general broad ideas and not specific designs aimed at a narrow use.

### FREQUENCY REGULATION OF A DC TO AC INVERTER

Zener diodes are often used in control circuits, usually to control the magnitude of the output voltage or current. In this unusual application, however, the zener is used to control the output frequency of a current feedback inverter. The circuit is shown in Figure 1.



**Figure 1. Frequency Controlled Current  
Feedback Inverter**

The transformer  $T_1$  functions as a current transformer providing base current  $I_B = (N_C/N_B)I_C$ . Without the zener diode, the voltage across  $N_B$  windings of the timing transformer  $T_1$  is clamped to  $V_{BE}$  of the ON device, giving an inverter frequency of

$$f = \frac{V_{BE} \times 10^8}{4BS_1A_1N_B}$$

where  $BS_1A_1$  is the flux capacity of  $T_1$  transformer core. The effect on output frequency of  $V_{BE}$  variations due to changing load or temperature can be reduced by using a zener diode in series with  $V_{BE}$  as shown in Figure 1. For this circuit, the output frequency is given by

$$f = \frac{(V_{BE} + V_Z) \times 10^8}{4BS_1A_1N_B}$$

If  $V_{BE}$  is small compared to the zener voltage  $V_Z$ , good frequency accuracy is possible. For example, with  $V_Z = 9.1$  volts, a 40 Watt inverter using 2N3791 transistors (operating from a 12 volt supply), exhibited frequency regulation of  $\pm 2\%$  with  $\pm 25\%$  load variation.

Care should be taken not to exceed  $V_{(BR)EBO}$  of the non-conducting transistor, since the reverse emitter-base voltage will be twice the introduced series voltage, plus  $V_{BE}$  of the conducting device.

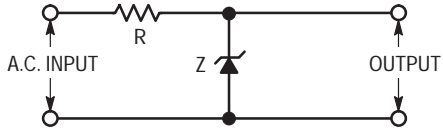
Transformer  $T_2$  should not saturate at the lowest inverter frequency.

Inverter starting is facilitated by placing a resistor from point A to  $B_1$  or a capacitor from A to  $B_2$ .

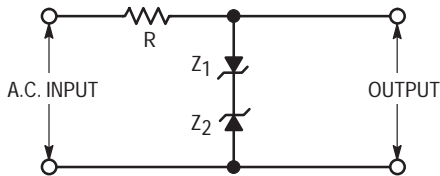
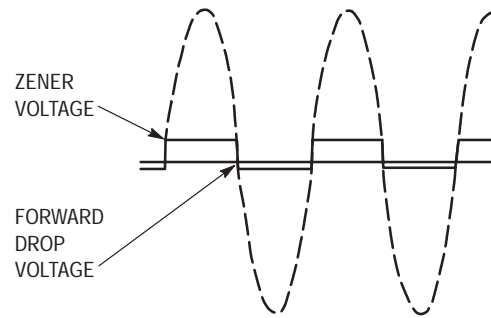
### SIMPLE SQUARE WAVE GENERATOR

The zener diode is widely used in wave shaping circuits; one of its best known applications is a simple square wave generator. In this application, the zener clips sinusoidal waves producing a square wave such as shown in Figure 2a. In order to generate a wave with reasonably vertical sides, the ac voltage must be considerably higher than the zener voltage.

Clipper diodes with opposing junctions built into the device are ideal for applications of the type shown in Figure 2b.



(a) Single Zener Diode Square Wave Generator



(b) Opposed Zener Diodes Square Wave Generator

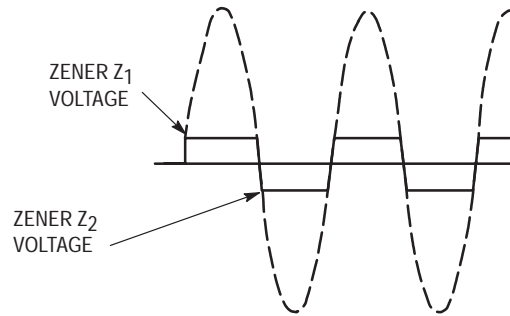


Figure 2. Zener Diode Square Wave Generator

# Chapter 10

## TRANSIENT VOLTAGE SUPPRESSION

### INTRODUCTION

Electrical transients in the form of voltage surges have always existed in electrical distribution systems, and prior to the implementation of semiconductor devices, they were of minor concern. The vulnerability of semiconductors to lightning strikes was first studied by Bell Laboratories in 1961.<sup>1</sup> A later report tried to quantify the amount of energy certain semiconductors could absorb before they suffered latent or catastrophic damage from electrostatic discharge.<sup>2</sup> Despite these early warnings, industry did not begin to address the issue satisfactorily until the late 1970s. Listed below are the seven major sources of overvoltage.

- Lightning
- Sunspots
- Switching of Loads in Power Circuits
- Electrostatic Discharge
- Nuclear Electromagnetic Pulses
- Microwave Radiation
- Power Cross

Most electrical and electronic devices can be damaged by voltage transients. The difference between them is the amount of energy they can absorb before damage occurs. Because many modern semiconductor devices, such as small signal transistors and integrated circuits can be damaged by disturbances that exceed the voltage ratings at only 20 volts or so, their survivability is poor in unprotected environments.

In many cases, as semiconductors have evolved their ruggedness has diminished. The trend to produce smaller and faster devices, and the advent of MOSFET and gallium arsenide FET technologies has led to an increased vulnerability. High impedance inputs and small junction sizes limit the ability of these devices to absorb energy and to conduct large currents. It is necessary, therefore, to supplement vulnerable electronic components with devices specially designed to cope with these hazards. Listed below are the four primary philosophies for protecting against transients.

- Clamping, or “clipping” is a method of limiting the amplitude of the transient.
- Shunting provides a harmless path for the transient, usually to ground by way of an avalanche or a crowbar mechanism.
- Interrupting opens the circuit for the duration of the transient.
- Isolating provides a transient barrier between hostile environments and vulnerable circuits through the use of transformers or optoisolators.

Selection of the proper protective method should be made based upon a thorough investigation of the potential sources of the overvoltage hazard. Different applications and environments present different sources of overvoltage.

### LIGHTNING

At any given time there are about 1800 thunderstorms in progress around the world, with lightning striking about 100 times each second. In the U.S., lightning kills about 150 people each year and injures another 250. In flat terrain with an average lightning frequency, each 300 foot structure will be hit, on average, once per year. Each 1200 foot structure, such as a radio or TV tower, will be hit 20 times each year, with strikes typically generating 600 million volts.

Each cloud-to-ground lightning flash really contains from three to five distinct strokes occurring at 60 ms intervals, with a peak current of some 20,000 amps for the first stroke and about half that for subsequent strokes. The final stroke may be followed by a continuing current of around 150 amps lasting for 100 ms.

The rise time of these strokes has been measured at around 200 nanoseconds or faster. It is easy to see that the combination of 20,000 amps and 200 ns calculates to a value of  $di/dt$  of  $10^{11}$  amps per second! This large value means that transient protection circuits must use RF design techniques, particularly considerate of parasitic inductance and capacitance of conductors.

While this peak energy is certainly impressive, it is really the longer-term continuing current which carries the bulk of the charge transferred between the cloud and ground. From various field measurements, a typical lightning model has been constructed, as shown in Figure 1.

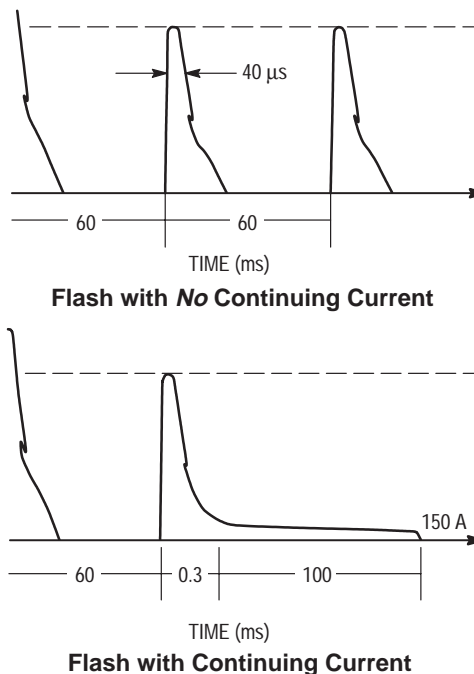


Figure 1. Typical Lightning Model, with and without Continuing Current

Depending on various conditions, continuing current may or may not be present in a lightning strike. A severe lightning model has also been created, which gives an indication of the strength which can be expected during worst case conditions at a point very near the strike location. Figure 2 shows this model. Note that continuing current is present at more than one interval, greatly exacerbating the damage which can be expected. A severe strike can be expected to ignite combustible materials.

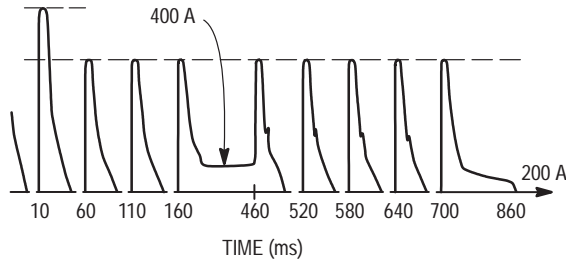


Figure 2. Severe Lightning Model

A direct hit by lightning is, of course, a dramatic event. In fact, the electric field strength of a lightning strike nearby may be enough to cause catastrophic or latent damage to semiconductor equipment. It is a more realistic venture to try to protect equipment from these nearby strikes than to expect survival from a direct hit.

With this in mind, it is important to be able to quantify the induced voltage as a function of distance from the strike. Figure 3 shows that these induced voltages can be quite high, explaining the destruction of equipment from relatively distant lightning flashes.

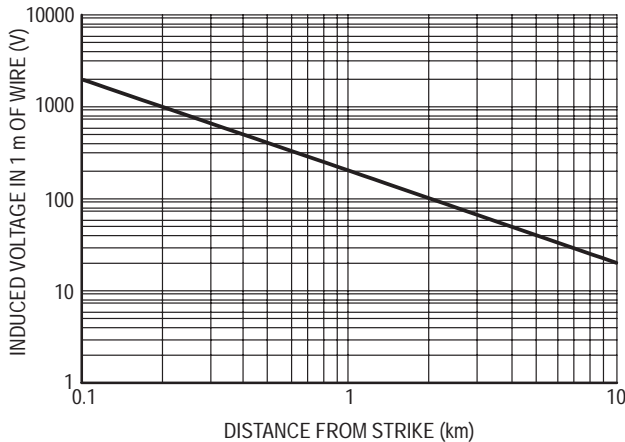


Figure 3. Voltage Induced by Nearby Lightning Strike

Burying cables does not provide appreciable protection as the earth is almost transparent to lightning radiated fields. In fact, underground wiring has a higher incidence of strikes than aerial cables.<sup>3</sup>

### SUNSPOTS

The sun generates electromagnetic waves which can disrupt radio signals and increase disturbances on residential and business power lines. Solar flares, which run in cycles of 11 years (1989 was a peak year) send out electromagnetic waves which disrupt sensitive equipment.

Although not quantified, the effects of sunspot activity should be considered. Sunspots may be the cause of sporadic, and otherwise unexplainable problems in such sensitive areas.

### SWITCHING OF LOADS IN POWER CIRCUITS

Inductive switching transients occur when a reactive load, such as a motor or a solenoid coil, is switched off. The rapidly collapsing magnetic field induces a voltage across the load's winding which can be expressed by the formula:

$$V = -L (di/dt)$$

where L is inductance in henrys and di/dt is the rate of change of current in amps per second.

Such transients can occur from a power failure or the normal opening of a switch. The energy associated with the transient is stored within the inductance at power interruption and is equal to:

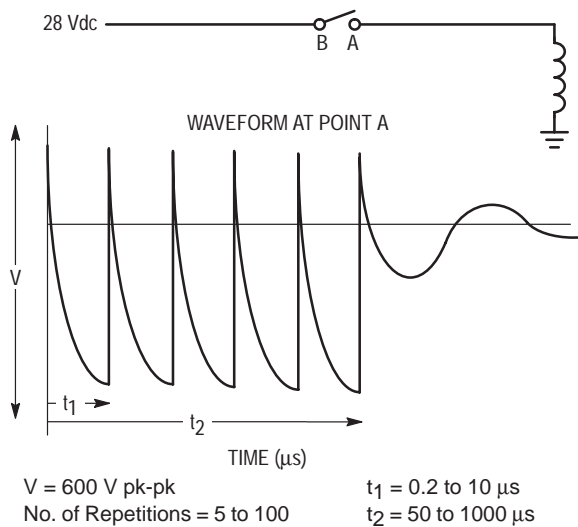
$$W = 1/2 Li^2$$

where W is energy in joules and i is instantaneous current in amps at the time of interruption.

As an example, a 1.4 to 2.5 kV peak transient can be injected into a 120 vac power line when the ignition system of an oil furnace is fired. It has also been shown that there are transients present on these lines which can reach as high as 6 kV. In locations without transient protection devices, the maximum transient voltage is limited to about 6 kV by the insulation breakdown of the wiring.

Inductive switching transients are the silent killers of semiconductors as they often occur with no outward indication. A graphic example is the report of a large elevator company indicating the failure of 1000 volt rectifiers during a power interruption. In another area, power interruption to a 20 HP pump motor in a remote area was directly related to failure of sensitive monitoring equipment at that same site.<sup>4</sup>





**Figure 4. Switching Transient Definition for Aircraft and Military Buses, per Boeing Document D6-16050**

After characterizing electrical overstress on aircraft power buses, Boeing published **Document D6-16050** as shown in Figure 4.

The military has developed switching transient definitions within several specifications including:

**DOD-STD-1399** for shipboard

**MIL-STD-704** for aircraft

**MIL-STD-1275** for ground vehicles

The International Electrotechnical Commission (IEC) is now promoting their specification **IEC 801-4** throughout the European community. This describes an inductive switching transient voltage threat having 50 ns wide spikes with amplitudes from 2 kV to 4 kV occurring in 300 ms wide bursts.<sup>5</sup>

Besides these particular military specifications, many are application specific and functional tests exist. A supplier of transient voltage suppressor components will be expected to perform to a wide variety of them.

## ELECTROSTATIC DISCHARGE (ESD)

ESD is a widely recognized hazard during shipping and handling of many semiconductor devices, especially those that contain unprotected MOSFETs, semiconductors for use at microwave frequencies and very high speed logic with switching times of 2 ns or less. In response to this threat, most semiconductors are routinely shipped in containers made of conductive material.

In addition to various shipping precautions, electronic assembly line workers should be grounded, use grounded-tip soldering irons, ionized air blowers and other techniques to prevent large voltage potentials to be generated and possibly discharged into the semiconductors they are handling.

Once the assembled device is in normal operation, ESD damage can still occur. Any person shuffling his feet on a carpet and then touching a computer keyboard can possibly cause a software crash or, even worse, damage the keyboard electronics.

The electrical waveform involved in ESD is a brief pulse, with a rise time of about 1 ns, and a duration of 100–300  $\mu\text{s}$ . The peak voltage can be as large as 30 kV in dry weather, but is more commonly 0.5–5.0 kV.<sup>6</sup> The fastest rise times occur from discharges originating at the tip of a hand-held tool, while discharges from the finger tip and the side of the hand are slightly slower.<sup>7</sup> A typical human with a body capacitance of 150 pF, charged to 3 microcoulombs, will develop a voltage potential of 20 kV, according to the formula:

$$V = Q / C$$

where V is voltage, Q is charge and C is capacitance. The energy delivered upon discharge is:

$$W = 1/2 CV^2$$

where W is energy in joules, C is capacitance and V is voltage.

It is interesting to note that most microcircuits can be destroyed by a 2500 volt pulse, but a person cannot feel a static spark of less than 3500 volts!

## NUCLEAR ELECTROMAGNETIC PULSES (NEMP)

When a nuclear weapon is detonated, a very large flux of photons (gamma rays) is produced. These rays act to produce an electromagnetic field known as a nuclear electromagnetic pulse or NEMP. When a nuclear detonation occurs above the atmosphere, a particularly intense pulse illuminates all objects on the surface of the earth, and all objects in the lower atmosphere within line of sight of the burst. A burst 300–500 km above Kansas would illuminate the entire continental U.S.

A typical NEMP waveform is a pulse with a rise time of about 5 ns and a duration of about 1  $\mu\text{s}$ . Its peak electric field is 50–100 kV/m at ground level. After such a pulse is coupled into spacecraft, aircraft and ground support equipment, it produces a waveform as described in **MIL-STD-461C**. The insidious effect of NEMP is its broad coverage and its potential for disabling military defense systems.

## MICROWAVE RADIATION

Microwaves can be generated with such high power that they can disable electronic hardware upon which many military systems depend. A single pulse flux of  $10^{-8} \text{ MJ/cm}^2$  burns out receiver diodes, and a flux of  $10^{-4} \text{ MJ/cm}^2$  causes bit errors in unshielded computers.<sup>8</sup> With automobiles utilizing MPU controls in more applications, it is important to protect against the effects of driving by a microwave transmitter. Likewise, a nearby lightning strike could also have detrimental effects to these systems.

## POWER CROSS

Yet another source of electrical overstress is the accidental connection of signal lines, such as telephone or cable television, to an ac or dc power line. Strictly speaking, this phenomenon, known as a power cross, is a continuous state, not a transient. However, the techniques for ensuring the

survival of signal electronics after a power cross are similar to techniques used for protection against transient overvoltages.

### STANDARDIZED WAVEFORMS

Fortunately, measurements of these hazards have been studied and documented in several industry specifications. For example, Bellcore **Technical Advisory TA-TSY-000974** defines the generic measurement waveform for any double exponential waveform, which is the basis for most of the specific applications norms.

The predominant waveform for induced lightning transients, set down by Rural Electrification Administration **Document PE-60**, is shown in Figure 5. This pulse test, performed at the conditions of 100 V/μs rise, 10/1000 μs,  $I_p = 1$  kV, is one of the two most commonly specified in the industry. The other is the 8/20 μs waveform, shown in Figure 6.

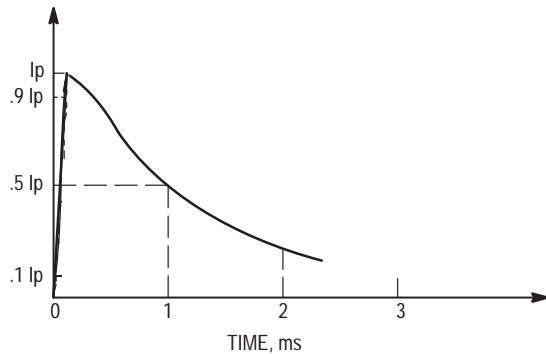


Figure 5. Pulse Waveform (10/1000 μs)

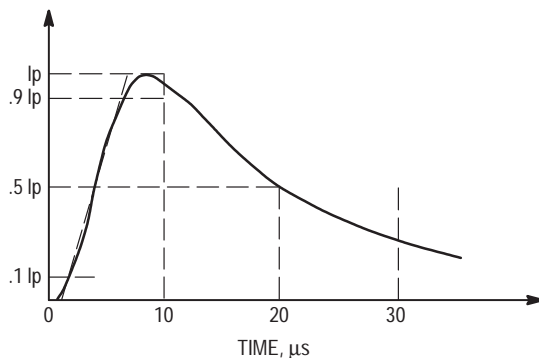


Figure 6. Pulse Waveform (8/20 μs)

## TRANSIENT VOLTAGE SUPPRESSION AND TELECOM

### TRANSIENT VOLTAGE SURGE SUPPRESSION COMPONENTS ON DATA AND TELEPHONE LINES

Lines carrying data and telephone signals are subject to a number of unwanted and potentially damaging transients primarily from two sources: lightning and “power crosses.” A power cross is an accidental connection of a signal line

to a powerline. Transients from lightning can impress voltages well above a kilovolt on the line but are of short duration, usually under a millisecond. Lightning transients are suppressed by using Transient Voltage Surge Suppressor (TVS) devices. TVS devices handle high peak currents while holding peak voltage below damaging levels, but have relatively low energy capability and cannot protect against a power cross fault. The first TVS used by telephone companies is the carbon block, but its peak let-through voltage was too high for modern equipment using unprotected solid state circuitry. A number of other components fill today’s needs.

The power cross condition causes a problem with telephone lines. Fast acting fuses, high speed circuit breakers and positive temperature coefficient thermistors have been successfully used to limit or interrupt current surges exceeding a millisecond.

Over the years, telecommunications switching equipment has been transitioning from electromechanical relays to integrated circuits and MOSFET technology. The newer equipment operates at minimal electrical currents and voltages, which make it very efficient. It is therefore quite sensitive to electrical overloads caused by lightning strikes and other transient voltage sources, and by power crosses.

Because of the deployment of new technology, both in new installations and in the refurbishment of older systems, the need for transient protection has grown rapidly. It is widely recognized that any new equipment must include protection devices for reasons of safety, reliability and long term economy.

The major telecom companies, in their never ending quest for the elimination of electromechanical technology have been looking at a number of novel methods and implementations of protection. These methods provide for solutions to both the primary and secondary protection categories.

A number of studies have been conducted to determine the transient environment on telephone lines. Very little has been done with data lines because a typical situation does not exist. However, information gathered from telephone line studies can serve as a guide for data lines.

Past studies on telephone lines coupled with the high current capability of arc type arrestors and the conservative nature of engineers seem to have produced specifications which far exceed the real need. A recent study by Bell South Services<sup>9</sup> reported that the highest level of transient energy encountered was well below standards and specifications in common use. Now, solid state devices perform adequately for many applications. However the stringent specifications of some regulatory agencies promote arc-type arrestors, though solid state devices would be a better choice.

### PRIMARY PROTECTION

Primary protection is necessary to protect against high voltage transients which occur in the outdoor environment. These transients include induced lightning surges and arc cross conditions.

As such, primary protection is located at the point where wiring enters the building or terminal box. It is the first line defense against outside hazards. TVS devices located where lines enter a building are called primary protectors. Protectors connected to indoor lines are referred to as secondary protectors. Both primary and secondary protectors are required to provide complete equipment protection.

Today, primary protection is most generally accomplished through the use of surge protector modules. For telecom, these are designed specifically for the environment and the standards dictated by the telecom applications. They typically contain a two or three element gas arrestor tube and a mechanically-triggered heat coil. Some also include air gap carbon block arrestors which break over at voltages above about 1500 volts.

Some modules contain high speed diodes for clamp response in the low nanoseconds. This provides protection until the gas tube fires, generally in about one microsecond. The diodes may be connected between the tip, ring and ground conductors in various combinations. The 5ESS electronic switching system norms dictate design and performance requirements of TVS modules in use today. Test methods are spelled out in **REA PE-80**, a publication of the Rural Electrification Administration.

In the U.S. alone, 58 million primary protection modules are sold annually, about 40 million for central offices and 18 million for station locations, such as building entrances. Eighty percent of these use gas tubes, 16% use air-gap carbon blocks, and only 2% (so far) are solid state.

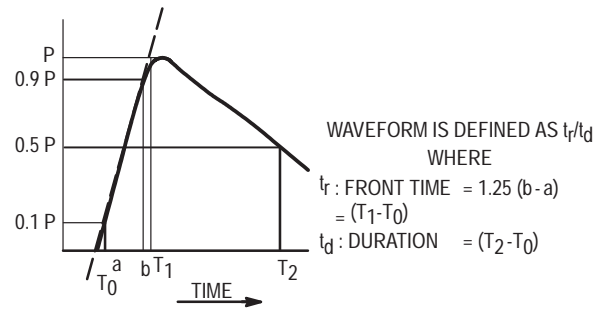
## SECONDARY PROTECTION

Secondary protection is necessary for the equipment inputs, and as such, is located between the primary protector and the equipment. Secondary protection is generally accomplished with one or more TVS components, as opposed to the modules used for primary. It is often placed on a circuit board along with other components handling other duties, such as switching. Secondary protection is applied to lines associated with long branch circuits which have primary protection a significant distance away, to internal data lines, and to other locations requiring additional local hazard-proofing.

While not as open to external transients as the primary, secondary can still see peak open circuit voltages in excess of 1000 volts and short circuit currents of hundreds of amps. These transients may be locally generated, or they may be residuals from the primary protectors upstream.

## STANDARDS

Transient voltage waveforms are commonly described in terms of a dual exponential wave as defined in Figure 7. The standard chosen for power lines is a 1.2/50  $\mu\text{s}$  voltage wave which causes an 8/20  $\mu\text{s}$  current wave. Although the source of the most severe transients on telecom lines is the same as for power lines and lightning, the higher impedance per unit length of the telephone line stretches the waves as they propagate through the lines.



**Figure 7. Definition of Double Exponential Impulse Waveform**

The 10/1000  $\mu\text{s}$  wave approximates the worst case waveform observed on data and telecom lines. TVS devices intended for this service are usually rated and characterized using a 10/1000 waveform. The Bell South study revealed that the worst transient energy handled by primary protectors on lines entering a central office was equivalent to only 27 A peak of a 10/1000 wave. This level is considerably less than that required by secondary protectors in most of the standards in use today. This finding is particularly significant because the Bell South service area includes Central Florida, the region experiencing the highest lightning activity in the United States.

The United States Federal Communications Commission (FCC) has defined mandatory requirements for equipment which is to be connected to the U.S. telephone network. In some cases, U.S. equipment must meet standards developed by the Rural Electrification Agency (REA). Many nations demand compliance to standards imposed by the Consultative Committee, International Telegraph and Telephone (CCITT). In addition, most equipment users demand safety certification from U.L., which has its own standards.

The FCC Standards are based on a worst case residue from a carbon block primary protector installed where the phone line enters the building. The CCITT standard is applicable for situations lacking primary protection, other than wiring flashover. Companies entering the telephone equipment or protector market will need to obtain and become familiar with the appropriate governing standards.

## TRANSIENT VOLTAGE PROTECTION COMPONENTS

### GENERAL TVS CHARACTERISTICS

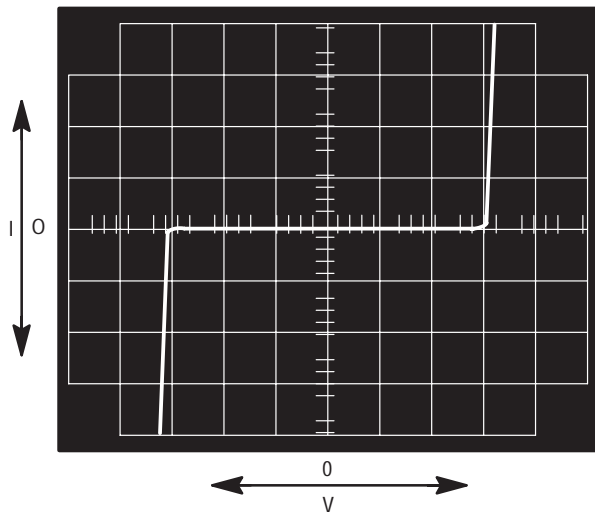
A number of transient voltage suppressor (TVS) devices are available. Each finds use in various applications based upon performance and cost. All types are essentially transparent to the line until a transient occurs; however, some devices have significant capacitance which loads the line for ac signals. A few of these are described in Table 1.

Based upon their response to an overvoltage, TVS devices fit into two main categories, clamps and crowbars. A clamp conducts when its breakdown voltage is exceeded and reverts back to an open circuit when the applied voltage drops below breakdown. A crowbar switches into a low

voltage, low impedance state when its breakover voltage is exceeded and restores only when the current flowing through it drops below a “holding” level.

**CLAMP DEVICES**

All clamp devices exhibit the general V-I characteristic of Figure 8. There are variations; however, some clamps are asymmetric. In the non clamping direction, some devices such as the zener TVS exhibit the forward characteristic of a diode while others exhibit a very high breakdown voltage and are not intended to handle energy of “reverse” polarity. Under normal operating conditions, clamp devices appear virtually as an open circuit, although a small amount of leakage current is usually present. With increasing voltage a point is reached where current increases rapidly with voltage as shown by the curved portion of Figure 8. The rapidly changing curved portion is called the “knee region.” Further increases in current places operation in the “breakdown” region.



**Figure 8. Static Characteristics of a Clamp Device**

In the knee region the V-I characteristic of clamping devices can be approximated by the equation:

$$I = K V^s \tag{1}$$

where K is a constant of proportionality and s is an exponent which defines the “sharpness factor” of the knee. The exponent s is 1 for a resistor and varies from 5 to over 100 for the clamping devices being used in TVS applications. A high value of s i.e., a sharp knee, is beneficial. A TVS device can be chosen whose breakdown voltage is just above the worst case signal amplitude on the line without concern of loading the line or causing excessive dissipation in the TVS.

As the current density in the clamp becomes high, the incremental resistance as described by Equation 1 becomes very small in comparison to the bulk resistance of the material. The incremental resistance is therefore ohmic in the high current region.

Unfortunately, a uniform terminology for all TVS devices has not been developed; rather, the terms were developed in conjunction with the appearance of each device in the marketplace. The key characteristics normally specified define operation at voltages below the knee and at currents above the knee.

Leakage current is normally specified below the knee at a voltage variously referred to as the stand-off voltage, peak working voltage or rated dc voltage. Some devices are rated in terms of an RMS voltage, if they are bidirectional. Normal signal levels must not exceed this working voltage if the device is to be transparent.

Breakdown voltage is normally specified at a fairly low current, typically 1 mA, which places operation past the knee region. Worst case signal levels should not exceed the breakdown voltage to avoid the possibility of circuit malfunction or TVS destruction.

The voltage in the high current region is called the clamping voltage,  $V_C$ . It is usually specified at the maximum current rating for the device. To keep  $V_C$  close to the breakdown voltage, s must be high and the bulk resistance low. A term called clamping factor, ( $F_C$ ) is sometimes used to describe the sharpness of the breakdown characteristic.  $F_C$  is the ratio of clamping voltage to the breakdown voltage. As the V-I characteristic curve of the TVS approaches a right angle, the clamping factor approaches unity. Clamping factor is not often specified, but it is useful to describe clamp device behavior in general terms.

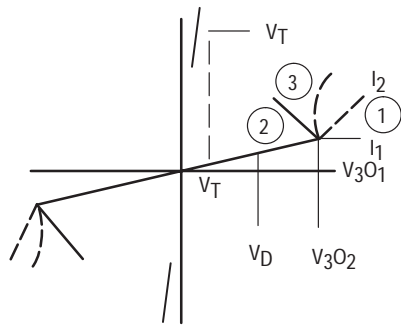
**Table 1. Comparison of TVS Components**

Type	Protection Time	Protection Voltage	Power Dissipation	Reliable Performance	Expected Life	Other Considerations
<b>GAS TUBE</b>	> 1 μs	60–100 V	Nil	No	Limited	Only 50–2500 surges. Can short power line.
<b>MOV</b>	10–20 ns	> 300 V	Nil	No	Degrades	Fusing required. Degrades. Voltage level too high.
<b>AVALANCHE TVS</b>	50 ps	3–400 V	Low	Yes	Long	Low power dissipation. Bidirectional requires dual.
<b>THYRISTOR TVS</b>	< 3 ns	30–400 V	Nil	Yes	Long	High capacitance. Temperature sensitive.

Clamp devices generally react with high speed and as a result find applications over a wide frequency spectrum. No delay is associated with restoration to the off state after operation in the breakdown region.

**CROWBAR DEVICES**

Crowbar TVS devices have the general characteristics shown in Figure 9. As with clamp devices, asymmetric crowbars are available which may show a diode forward characteristic or a high voltage breakdown in one direction.



**Figure 9. Static Characteristics of a Bidirectional Crowbar Device**

The major difference between a crowbar and a clamp is that, at some current in the breakdown region, the device switches to a low voltage on-state. In the clamping region from  $I_1$  to  $I_2$ , the slope of the curve may be positive as shown by segment 1, negative (segment 2) or exhibit both characteristics as shown by segment 3. A slightly positive slope is more desirable than the other two curves because a negative resistance usually causes a burst of high frequency oscillation which may cause malfunction in associated circuitry. However, a number of performance and manufacturing trade-offs affect the shape of the slope in the clamping region.

A crowbar TVS has an important advantage over a clamp TVS in that it can handle much larger transient surge current densities because the voltage during the surge is considerably lower. In a telephone line application, for example, the clamping level must exceed the ring voltage peak and will typically be in the vicinity of 300 volts during a high current surge. The on-state level of the crowbar may be as low as 3 volts for some types which allows about two orders of magnitude increase in current density for the same peak power dissipation.

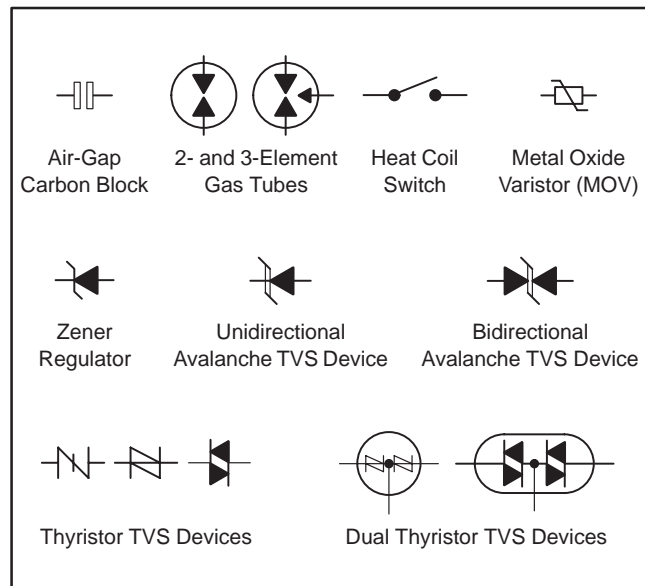
However, a crowbar TVS becomes "latched" in the on-state. In order to turn off its current flow the driving voltage must be reduced below a critical level called the holding or extinguishing level. Consequently, in any application where the on-state level is below the normal system voltage, a follow-on current occurs. In a dc circuit crowbars will not turn off unless some means is provided to interrupt the current. In an ac application crowbars will turn off near the zero crossing of the ac signal, but a time delay is associated with turn-off which limits crowbars to relatively low frequency applications. In a data line or telecom application the turn-off

delay causes a loss of intelligence after the transient surge has subsided.

A telephone line has both ac and dc signals present. Crowbars can be successfully used to protect telecom lines from high current surges. They must be carefully chosen to ensure that the minimum holding current is safely above the maximum dc current available from the lines.

**TVS DEVICES**

A description of the various types of TVS devices follows in the chronological order in which they became available. Used appropriately, sometimes in combination, any transient protection problem can be suitably resolved. Their symbols are shown in Figure 10.



**Figure 10. TVS Devices and Their Symbols**

**AIR GAP ARRESTORS**

The air gap is formed by a pair of metal points rigidly fixed at a precise distance. The air ionizes at a particular voltage depending upon the gap width between the points. As the air ionizes breakover occurs and the ionized air provides a low impedance conductive path between the points.

The breakover threshold voltage is a function of the air's relative humidity; consequently, open air gaps are used mainly on high voltage power lines where precise performance is not necessary. For more predictable behavior, air gaps sealed in glass and metal packages are also available.

Because a finite time is required to ionize the air, the actual breakover voltage of the gap depends upon the rate of rise of the transient overvoltage. Typically, an arrester designed for a 120 V ac line breaks over at 2200 volts.

Air gaps handle high currents in the range of 10,000 amperes. Unfortunately, the arc current pits the tips which causes the breakover voltage and on-state resistance to increase with usage.

**CARBON BLOCK ARRESTORS**

The carbon block arrestor, developed around the turn of the century to protect telephone circuits, is still in place in many older installations. The arrestor consists of two carbon block electrodes separated by a 3 to 4 mil air gap. The gap breaks over at a fairly high level — approximately 1 kV — and cannot be used as a sole protection element for modern telecom equipment. The voltage breakdown level is irregular. With use, the surface of the carbon block is burned which increases the unit's resistance. In addition, the burned material forms carbon tracks between the blocks causing a leakage current path which generates noise. Consequently, many of the carbon blocks in service are being replaced by gas tubes and are seldom used in new installations.

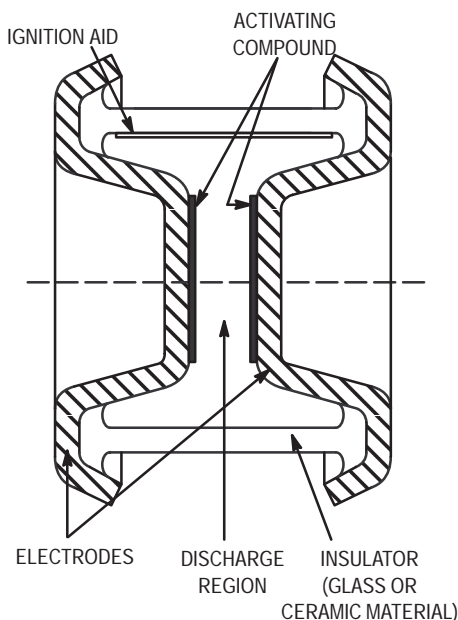
**SILICON CARBIDE VARISTORS**

The first non-linear resistor to be developed was called a "varistor." It was made from specially processed silicon carbide and found wide use in high power, high voltage TVS applications. It is not used on telecom lines because its clamping factor is too high:  $s$  is only about 5.

**GAS SURGE ARRESTORS**

Gas surge arrestors are a sophisticated modification of the air gap more suited to telecom circuit protection. Most often used is the "communication" type gap which measures about 3/8 inch in diameter and 1/4 inch thick. A cross section is shown in Figure 11. They consist of a glass or ceramic envelope filled with a low pressure inert gas with specialized electrodes at each end. Most types contain a minute quantity of radioactive material to stabilize breakover voltage. Otherwise, breakover is sensitive to the level of ambient light.

Because of their small size and fairly wide gap, capacitance is very low, only a few picofarads. When not activated, their off-state impedance or insulation resistance is virtually infinite.

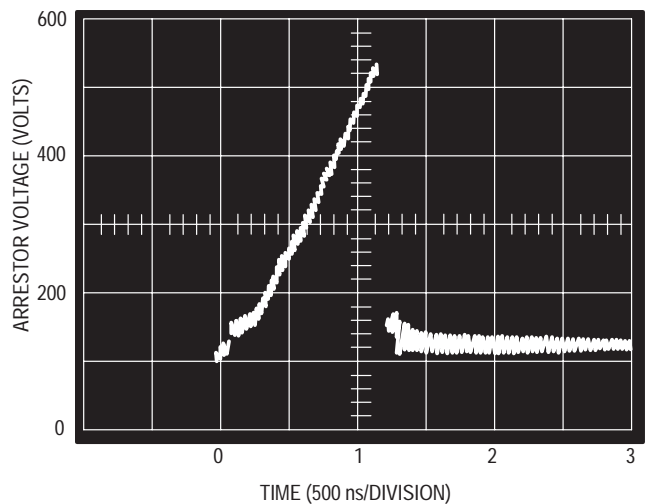


**Figure 11. Gas Arrestor Cross Section**

Key electrical specifications for this TVS type include breakover voltage (dc & pulse), maximum holdover voltage, arc voltage, and maximum surge current.

The breakover voltage is rated at a slow rate of rise, 5000 V/s, essentially dc to a gas arrestor. Typical dc voltage ratings range from 75 V through 300 V to provide for most communication systems protection requirements. The maximum pulse voltage rating is that level at which the device fires and goes into conduction when subjected to a fairly rapid rate of voltage rise, (dv/dt) usually 100 V/ $\mu$ s. Maximum rated pulse voltages typically range from 400 V to 600 V, depending on device type.

A typical waveform of a gas surge arrestor responding to a high voltage pulse is shown in Figure 12. From the waveform, it can be seen that the dv/dt of the wave is 100v/ $\mu$ s and the peak voltage (the breakover voltage) is 520 V.



**Figure 12. Voltage Waveform of Gas Surge Arrestor Responding to a Surge Voltage**

Gas surge arrestors fire faster but firing voltage increases as the transient wave fronts increase in slope as illustrated in Figure 13. The near vertical lines represent the incident transient rise time. Note that the response time is greater than 0.1s at slow rise times but decreases to less than 0.1  $\mu$ s for risetimes of 20 kV/ $\mu$ s. However, the firing voltage has increased to greater than 1000 V for the gas tube which breaks over at 250 Vdc.

The driving circuit voltage must be below the holdover voltage for the gap to extinguish after the transient voltage has passed. Holdover voltage levels are typically 60% to 70% of the rated dc breakdown voltage.

Arc voltage is the voltage across the device during conduction. It is typically specified at 5 to 10 V under a low current condition, but can exceed 30 V under maximum rated pulse current.

The maximum surge current rating for a 8/20  $\mu$ s waveform is typically in the 10 kA to 20 kA range for communication type devices. For repetitive surges with a 10/1000 wave, current ratings are typically 100 A, comfortably above the typical exposure levels in a telephone subscriber loop.

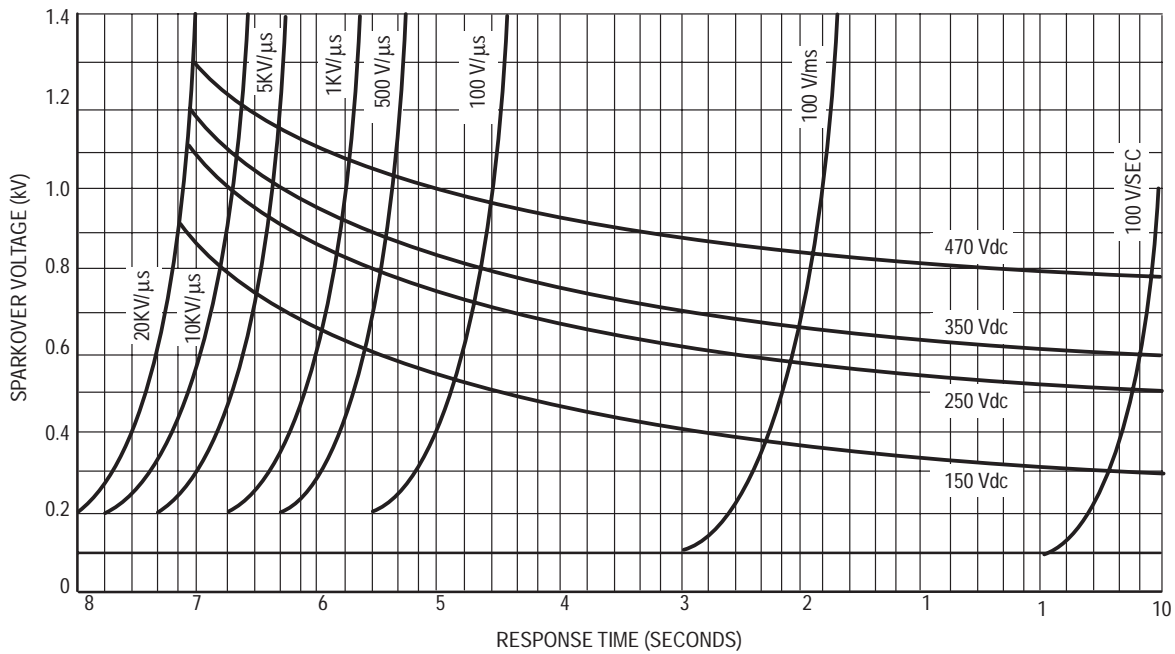


Figure 13. Typical Response Time of a Gas Surge Arrestor

Gas tubes normally provide long life under typical operating conditions, however; wear-out does occur. Wear-out is characterized by increased leakage current and firing voltage. An examination of gas tubes in service for six to eight years revealed that 15% were firing outside of their specified voltage limits.<sup>9</sup> Because firing voltage increases with use, protectors often use an air gap backup in parallel with the gas tube. End-of-life is often specified by manufacturers as an increase of greater than 50% of breakover or firing voltage. Other limits include a decrease in leakage resistance to less than 1 mW.

The features and limitations of gas tube surge arrestors are listed below.

**Advantages:**

- High current capability
- Low capacitance
- Very high off-state impedance

**Disadvantages:**

- Slow response time
- Limited life
- High let-through voltage
- Open circuit failure mode

Principally because of their high firing voltage, gas surge arrestors are not suitable for use as the sole element to protect modern equipment connected to a data or telecom line. However, they are often part of a protection network where they are used as the primary protector at the building interface with the outside world.

**SELENIUM CELLS**

Polycrystalline diodes formed from a combination of selenium and iron were the forerunners of monocrystalline semiconductor diodes. The TVS cells are built by depositing

the polycrystalline material on a metal plate to increase their thermal mass thereby raising energy dissipation. The cells exhibit typical diode characteristics and a non-linear reverse breakdown which is useful for transient suppression. Cells can be made which are “self-healing”; that is, the damage which occurs when subjecting them to excessive transient current is repaired with time.

Selenium cells are still used in high power ac line protection applications because of their self-healing characteristic; however, their high capacitance and poor clamping factor ( $s \gg 8$ ) rule them out for data or telecom line applications.

**METAL OXIDE VARISTORS**

The metal oxide varistor (MOV) is composed of zinc oxide granules in a matrix of bismuth and other metal oxides. The interface between the zinc oxide and the matrix material exhibits characteristics similar to that of a p-n junction having a voltage breakdown of about 2.6 V. With this structure the electrical equivalent is that of groups of diodes in parallel which are stacked in series with similar parallel groups to provide the desired electrical parameters. The taller the stack, the higher the breakdown and operating voltage. Larger cross-sections provide higher current capability. The structure of an MOV is shown in Figure 14.

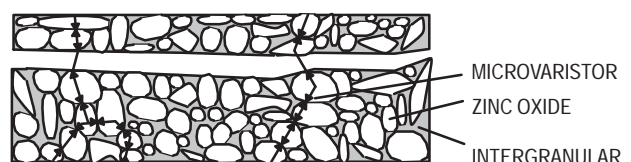
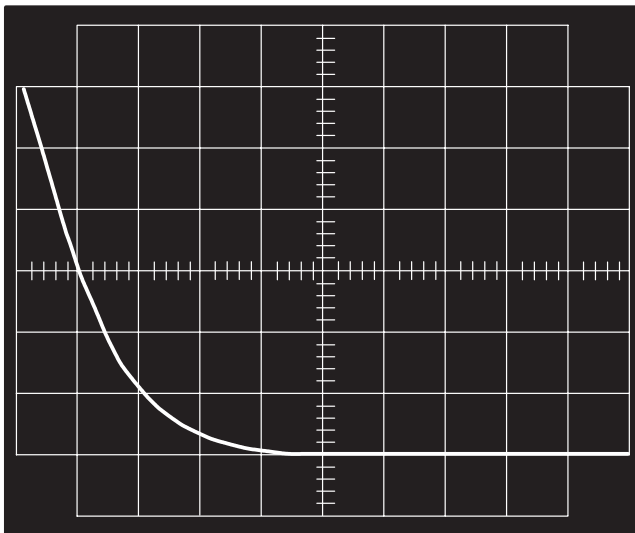


Figure 14. MOV Cross Section



MOV (27 V)  
 Vert: 10 V/div  
 Horiz: 0.5 ms/div  
 Transient Source Impedance: 0.55 Ω  
 $V_{peak} = 62.5 V$

Figure 15. MOV Clamping Voltage Waveform

MOVs, formed from a ceramic-like material, are usually produced in the shape of discs with most widely used MOVs having diameters of 7mm, 14mm, and 20mm. The disc surfaces are coated with a highly conductive metal such as silver to assure uniform conduction through the cross sectional area of the device. After terminal attachment the parts are coated with a durable plastic material.

The typical voltage spectrum of MOVs ranges from 8 V through 1000 V for individual elements. Pulse current capability (8/20 μs) ranges from a few amperes to several thousands of amperes depending on the element's size. The V-I characteristic of MOVs is similar to Figure 8. Their clamping factor is fairly good; s is in the vicinity of 25.

Key electrical specifications include: operating voltage, breakdown voltage, peak current maximum clamping voltage, and leakage current.

The maximum operating voltage specified is chosen to be below the breakdown voltage by a margin sufficient to produce negligible heating under normal operating conditions. Breakdown voltage is the transition point at which a small increase in voltage results in a significant increase in current producing a clamping action. Maximum limits for breakdown voltage are typically specified at 1 mA with upper end limits ranging from 20% to 40% greater than the minimum breakdown voltage.

Maximum peak current is a function of element area and ranges from tens of amperes to tens of thousands of amperes. MOVs are typically pulse rated with an 8/20 μs waveform since they are intended primarily for use across power lines.

The clamping characteristics of a 27 V ac rated MOV, with a 4 joule maximum pulse capability is shown in Figure 15. The transient energy is derived from an exponentially decreasing pulse having a peak amplitude of 90 V. The pulse generator source impedance is 0.55 W. Peak clamping voltage is 62.5 V while the developed current is 50 A. The clamping factor calculates to be 2.3.

Leakage currents are listed for MOVs intended for use in sensitive protection applications but are not normally listed for devices most often used on power lines. Leakage current behavior is similar to that of a p-n junction. It roughly doubles for every 10°C increase in temperature and also shows an exponential dependence upon applied voltage. At a voltage of 80% of breakdown, leakage currents are several microamperes at a temperature of 50°C.

Although the theory of MOV operation is not fully developed, behavior is similar to a bidirectional avalanche diode. Consequently its response time is very fast.

Life expectancy is an important characteristic generated under pulse conditions. A typical example is shown in Figure 16. The data applies to 20 mm diameter disc types having rated rms voltage from 130 V to 320 V. Lifetime rating curves are usually given for each device family.

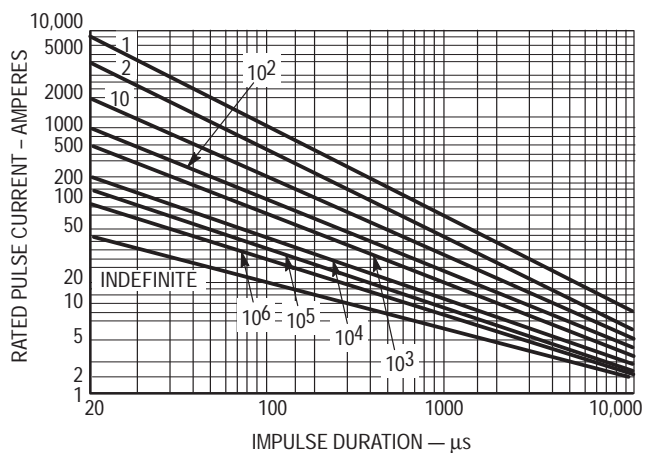


Figure 16. MOV Pulse Life Curve

For a single 8/20 μs pulse, the device described in Figure 16 is rated at 6500 A; however, it must be derated by more than two orders of magnitude for large numbers of pulses. Longer duration pulses also require further derating. For example, for a 10/1000 μs duration pulse, this family of



devices has a maximum pulse rating of about 100 A on a single shot basis and devices must be derated to less than 10A for long lifetimes in excess of 100,000 pulses.

End-of-life for an MOV is defined as the voltage breakdown degrading beyond the limits of  $\pm 10\%$ . As MOVs are pulsed, they degrade incrementally as granular interfaces are overheated and changed to a highly conductive state. Failure occurs in power line applications when the breakdown voltage has degraded to the point where the MOV attempts to clip the powerline peaks. In telecom applications, their breakdown must be above the peaks of the impressed ac line during a ring cycle or a power cross; otherwise an immediate catastrophic failure will occur.

When MOVs fail catastrophically they initially fail short. However, if a source of high energy is present as might occur with a power cross, the follow-on current may cause the part to rupture resulting in an open circuit.

The advantages and shortcomings of using an MOV for general purpose protection in microprocessor based circuitry include the following:

**Advantages:**

- High current capability
- Broad voltage spectrum
- Broad current spectrum
- Fast response
- Short circuit failure mode

**Disadvantages:**

- Gradual decrease of breakdown voltage
- High capacitance

The capacitance of MOVs is fairly high because a large device is required in order to achieve a low clamping factor; consequently, they are seldom used across telecom lines.

**ZENER TVS**

Zener TVS devices are constructed with large area silicon p-n junctions designed to operate in avalanche and handle much higher currents than their cousins, zener voltage regulator diodes. Some manufacturers use small area mesa chips with metal heatsinks to achieve high peak power capability. However, Motorola has determined that large area planar die produce lower leakage current and clamping factor. The planar construction cross section is shown in Figure 17 and several packages are shown in Figure 18.

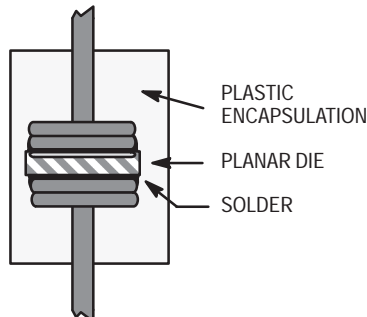


Figure 17. Zener TVS Cross-Section

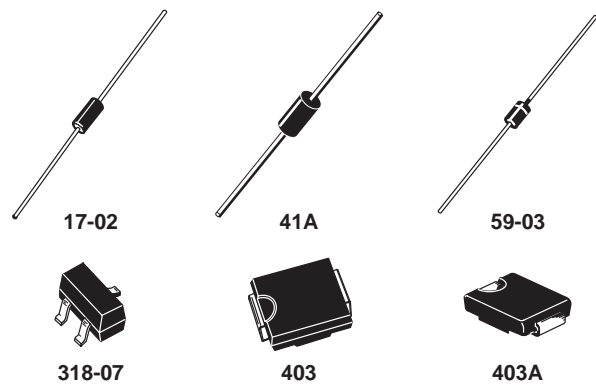


Figure 18. Typical Insertion and Surface Mount Silicon TVS Packages — Zeners and Thyristors

Key electrical parameters include maximum operating voltage, maximum reverse breakdown voltage, peak pulse current, peak clamping voltage, peak pulse power, and leakage current.

The normal operating or working voltage is usually called the reverse standoff voltage in specification sheets. Devices are generally available over the range of 5 V through 250 V. Standoff voltage defines the maximum peak ac or dc voltage which the device can handle. Standoff voltage is typically 10% to 15% below minimum reverse breakdown voltage. A listing of TVS products available from Motorola is shown in Table 2.

Table 2. Motorola Zener TVS Series

DEVICE SERIES	V <sub>Z</sub> RANGE	PULSE POWER RATING (100/1000 PULSE)	PACKAGE
*SA5.0A-SA170A	6.8-200	500 W	Axial
*P6KE6.8A - P6KE200A	6.8-200	600 W	Axial
*1.5KE6.8A - 1.5KE250A	6.8-250	1500 W	Axial
1SMB5.0AT3 - 1SMB170AT3	6.8-200	600 W	SMB
P6SMB6.8AT3 - P6SMB200T3	6.8-200	600 W	SMB
1SMC5.0AT3 - 1SMC78AT3	6.8-91	1500 W	SMC
1.5SMC6.8AT3 - 1.5SMC91AT3	6.8-91	1500 W	SMC
MMBZ15VDLT1	15	ESD Protection >15 kV	SOT-23

\* Available in bidirectional configurations

The reverse breakdown voltage is specified at a bias level at which the device begins to conduct in the avalanche mode. Test current levels typically are 1 mA for diodes which breakdown above 10 V and 10 mA for lower voltage devices. Softening of the breakdown knee, that is, lower  $s$ , for lower voltage p-n junction devices requires a higher test current for accurate measurements of reverse breakdown voltage. Diodes that break down above 10 V display a very sharp knee;  $s$  is over 100.

Peak pulse current is the maximum upper limit at which the device is expected to survive. Silicon p-n junctions are rated for constant power using a particular transient waveform; consequently, current is a function of the peak clamping voltage. For example, a 6.8 V device handles about 28 times the pulse current that a 220 V device will withstand; however, both the 6.8 V and 220 V types dissipate the same peak power under the same pulse waveform conditions. Most Zener TVS diodes are rated for 10/1000  $\mu$ s waveform pulses which are common in the telecom industry.

The clamping voltage waveform of a 27 V Zener TVS having a 1.5 joule capability is illustrated in Figure 19. Its peak voltage is 30.2 V. The transient energy source is the same as applied to the MOV whose response is shown in Figure 10. However, the current through the Zener TVS is over 100 A, much higher than occurs with the MOV because the clamping voltage is significantly lower. Despite the higher pulse current, the Zener displays much better clamping action; its clamping factor is 1.1.

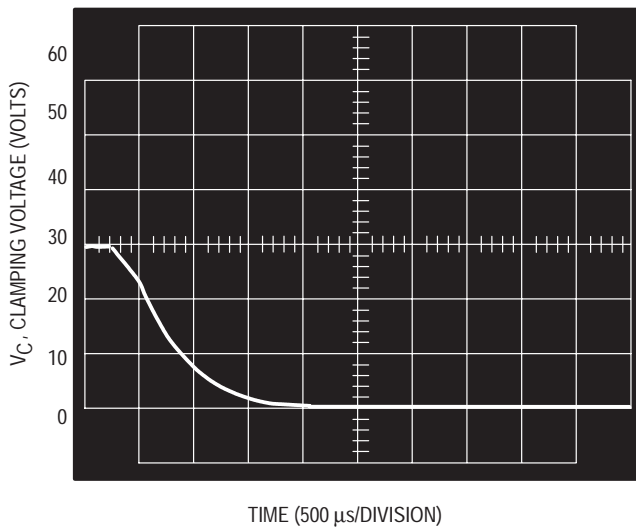


Figure 19. Zener TVS Clamping Voltage Waveform

Peak pulse power is the instantaneous power dissipated at the rated pulse condition. Common peak pulse power ratings are 500 W, 600 W, and 1500 W for 10/1000  $\mu$ s waveforms. As the pulse width decreases, the peak power capability increases in a logarithmic relationship. An example of a curve depicting peak pulse power versus pulse width is shown in Figure 20. The graph applies to the 1.5 kW series (10/1000 pulse) of TVS diodes and can be interpolated to

determine power ratings over a broad range of pulse widths. At 50  $\mu$ s, the maximum rated power shown in the curve is 6 kW, which is four times greater than the rating at 1ms. The current handling capability is also increased roughly by this same factor of four.

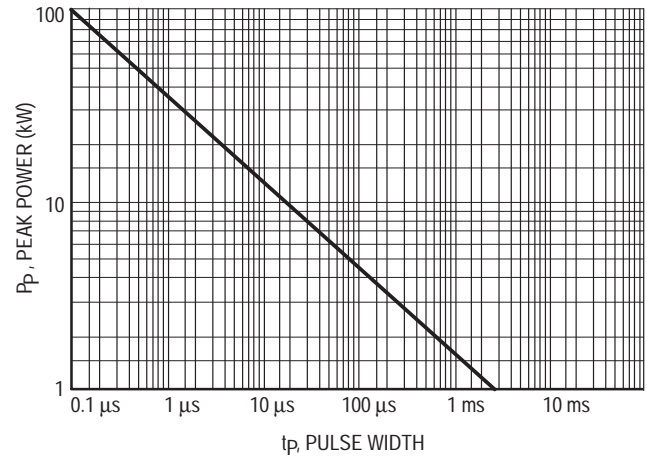


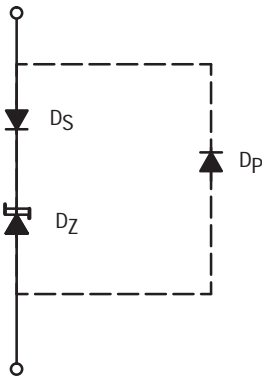
Figure 20. Peak Pulse Power Rating for a Popular Zener TVS Family

To increase power capability devices are stacked in series. For example, doubling the power capability requirement for a 100 V, 1.5 kW Zener TVS is easily done by placing two 50 V devices in series. Clamping factor is not significantly affected by this arrangement.

Although leakage current limits are relatively high for the industry low voltage types (500  $\mu$ A to 1000  $\mu$ A), dropping off to 5  $\mu$ A or less for voltages above 10 V, the planar die in use by Motorola exhibit considerably less leakage than the specified limits of the industry types.

Capacitance for the popular 1500 W family exceeds 10,000 pF at zero bias for a 6.8 V part, dropping exponentially to less than 100 pF for a 200 V device. Capacitance drops exponentially with a linear increase in bias. The capacitance of a 6.8 V device is 7000 pF, while the 200 V part measures under 60 pF, at their respective standoff voltages.

Capacitance loads the signal line at high frequencies. For high speed data transmission circuits, low capacitance is achieved by placing two diodes in a series stack as shown in Figure 21. Under normal operation the top diode ( $D_S$ ) operates at essentially zero bias current. Since its power dissipation requirement is small, its area can be much smaller than that of the TVS diode ( $D_Z$ ) in order to provide low capacitance. The top diode normally is not intended to be used in avalanche. Consequently if a negative voltage exceeding the reverse rating of the stack could occur, the low capacitance diode must be protected by another diode ( $D_P$ ) shown connected by dotted lines on Figure 21. The arrangement of Figure 21 is satisfactory for situations where the signal on the line is always positive. When the signal is ac, diode  $D_P$  is replaced by another low capacitance stack, connected in anti-parallel.



**Figure 21. A Series Stack to Achieve Low Capacitance with Zener TVS Diodes**

Switching speed is a prime attribute of the zener TVS. Avalanche action occurs in picoseconds but performing tests to substantiate the theory is extremely difficult. As a practical matter, the device may be regarded as responding instantaneously. Voltage overshoots which may appear on protected lines are the result of poor layout and packaging or faulty measurement techniques.

The p-n junction diode is a unidirectional device. For use on ac signal lines, bidirectional devices are available which are based upon stacking two diodes back to back. Most manufacturers use monolithic NPN and PNP structures. The center region is made relatively wide compared to a transistor base to minimize transistor action which can cause increased leakage current.

No wearout mechanism exists for properly manufactured Zener diode chips. They are normally in one of two states; good, or shorted out from over-stress. Long-term life studies show no evidence of degradation of any electrical parameters prior to failure. Failures result from stress which causes separation of the metal heat sink from the silicon chip with subsequent overheating and then failure. Like MOVs, silicon chips quickly fail short under steady state or long duration pulses which exceed their capabilities.

The strengths and weaknesses of Zener TVS devices are listed below.

**Advantages:**

- High repetitive pulse power ratings
- Low clamping factor
- Sub-nanosecond turn-on
- No wearout
- Broad voltage spectrum
- Short circuit failure mode

**Disadvantages:**

- Low non-repetitive pulse current
- High capacitance for low voltage types

Because of their fast response and low clamping factor, silicon devices are used extensively for protecting microprocessor based equipment from voltage surges on dc power buses and I/O ports.

### THYRISTOR DIODES

The most recent addition to the TVS arsenal is the thyristor surge suppressor (TSS). The device has the low clamping factor and virtually instantaneous response characteristic of a silicon avalanche (Zener) diode but, in addition, it switches to a low voltage on-state when sufficient avalanche current flows. Because the on-state voltage is only a few volts, the TSS can handle much higher currents than a silicon diode TVS having the same chip area and breakdown voltage. Furthermore, the TSS does not exhibit the large overshoot voltage of the gas tube.

Thyristor TVS diodes are available with unidirectional or bidirectional characteristics. The unidirectional type behaves somewhat like an SCR with a Zener diode connected from anode to gate. The bidirectional type behaves similarly to a triac having a bidirectional diode (Diac) from main terminal to gate.

Packaged TSS chips are shown in Figure 18. Figure 22a shows a typical positive switching resistance bidirectional TSS chip. Construction of the device starts with an n material wafer into which the p-bases and n-emitters are diffused. There are four layers from top to bottom on each side of the chip, forming an equivalent SCR. Only half the device conducts for a particular transient polarity.

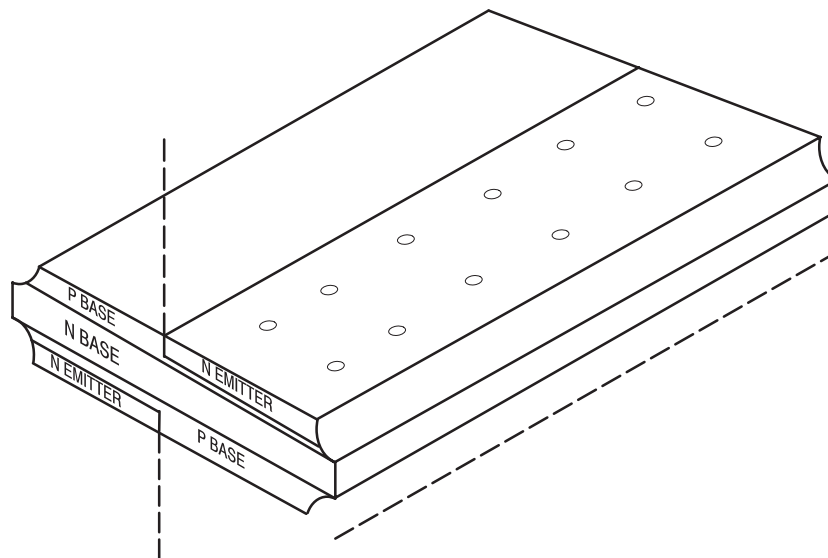


Figure 22a. Chip Construction

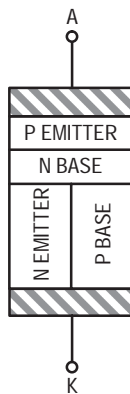


Figure 22b. Cross Section of Left Side



Figure 22c. Circuit Model of Left Side



Figure 22d. Circuit Symbol

The “gate” does not trigger the SCR, instead, operation in the Zener mode begins when the collector junction avalanches. Note that the p-bases pass through the n-emitters in a dot pattern and connect to the contact metal covering both halves of the chip. This construction technique provides a low resistance path for current flow and prevents it from turning on the NPN transistor. Therefore, at relatively low currents, the device acts like a low gain PNP transistor in breakdown. The Zener diode is the collector base junction of the PNP transistor. Negative resistance TSS devices are similarly constructed but start with p-type material wafer, allowing the fabrication of a high-gain NPN transistor. The switchback in voltage with increasing current is caused by the gain of the NPN.

Both device types switch on completely when the current flow through the base emitter shunt resistance causes enough voltage drop to turn on the emitter and begin four layer action. Now the device acts like an SCR. The collector

current of the PNP transistor (Figure 22c) provides the base drive for the NPN transistor. Likewise, the collector current of the NPN transistor drives the base of the PNP causing the two devices to hold one another on. Both the p and n emitters flood the chip with carriers resulting in high electrical conductivity and surge current capability.

When driven with high voltage ac, which occurs during a power cross, positive resistance TSS devices act like a Zener diode until the ac voltage drives the load line through the point where regeneration occurs. Then it abruptly switches to a low voltage. When the peak ac current is just below the current required for breakover, the device operates mainly as a Zener and power dissipation is high although the current is low. When the ac current peak is well above breakover, (>10 A), the device operates mainly as an SCR, and the low on-state voltage causes power dissipation to be relatively low.

Negative resistance devices operate in a similar fashion. However, their behavior is dependent upon the “load line,” that is, the equivalent resistance which the device “sees.” When the load resistance is high (>1000  $\Omega$ ) behavior is similar to that of a positive resistance TSS in that high instantaneous power dissipation occurs as the load line is driven along the high voltage region of the TSS prior to switching.

When a TSS with a negative resistance characteristic is driven with a low “load” resistance, switching occurs when the load line is tangent to the peak of the negative resistance curve. Thus, complete turn-on can occur at a very low current if the load resistance is low and the device has a “sharp” switchback characteristic.

Leakage and the Zener knee voltage increase with temperature at eight percent and 0.11% per  $^{\circ}\text{C}$  respectively for 200 V positive resistance types. But the current required to cause regeneration falls with temperature, causing less Zener impedance contribution to the breakover voltage, resulting in a large reduction in the breakover voltage temperature coefficient to as little as 0.05%/ $^{\circ}\text{C}$ . Negative resistance types can show positive or negative breakover voltage coefficients depending on temperature and the sharpness of the negative switchback.

The response of both positive and negative switching resistance units to fast transients involves a race between their Zener and regenerative attributes. At first the device conducts only in the small chip area where breakdown is occurring. Time is required for conduction to spread across the chip and to establish the currents and temperatures leading to complete turn-on. The net result is that both types exhibit increasing breakover voltage with fast transients. However, this effect is very small compared to gas discharge tubes, being less than 25% of the breakover voltage.

Negative resistance types are more sensitive to unwanted turn-on by voltage rates ( $dv/dt$ ) at peak voltages below the avalanche value. The transient current that flows to charge the self-capacitance of the device sets up an operating point on the negative resistance slope leading to turn-on. Reduction of  $dv/dt$  capability becomes significant when the signal voltage exceeds 80% of the avalanche value.

Complete turn-off following a transient requires the load line to intersect the device leakage characteristic at a point below the avalanche knee. During turn-off the load line must not meet an intermediate conducting state which can occur with a negative resistance device. Positive resistance types are free of states causing turn-off “sticking.” Both types have temperature sensitive holding currents that lie between 1 and 4 mA/ $^{\circ}\text{C}$ .

Recent product developments and published studies have generated much interest. Based on a study sponsored by Bell South,<sup>9</sup> the authors concluded that these new devices offered the highest level of surge protection available.

Key electrical parameters for the Thyristor TVS include operating voltage, clamping voltage, pulse current, on-state voltage, capacitance, and holding current.

Operating voltage is defined as the maximum normal voltage which the device should experience. Operating voltages from 60 V to 200 V are available.

Clamping voltage is the maximum voltage level attained before thyristor turn-on and subsequent transition to the on-state conduction mode. The transition stage to conduction may have any of the slopes shown in Figure 9.

The important voltages which define the thyristor operating characteristics are also shown in Figure 9.  $V_D$  is operating voltage,  $V_C$  is the clamping voltage and  $V_T$  is on-state voltage.

On-state voltage for most devices is approximately 3 V. Consequently, transient power dissipation is much lower for the thyristor TVS than for other TVS devices because of its low on-state voltage. For example, under power cross conditions Bell South Services reported their tests showed that the thyristor TVS devices handled short bursts of commercial power with far less heating than arc type surge arrestors.<sup>9</sup>

Capacitance is also a key parameter since in many cases the TSS is a replacement for gas surge arrestors which have low capacitance. Values for the TSS range from 100 pF to 200 pF at zero volts, but drop to about half of these values at a 50 Vdc bias.

Holding current ( $I_H$ ) is defined as the current required to maintain the on-state condition. Device thru-current must drop below  $I_H$  before it will restore to the non-conducting state. Turn-off time is usually not specified but it can be expected to be several milliseconds in a telecom application where the dc follow-on current is just slightly below the holding current.

The major advantages and limitations of the thyristor are:

**Advantages:**

- Fast response
- No wearout
- Produces no noise
- Short circuit failure mode

**Disadvantages:**

- Narrow voltage spectrum
- Non-restoring in dc circuits unless current is below  $I_H$
- Turn-off delay time

The thyristor TVS is finding wide acceptance in telecom applications because its characteristics uniquely match telecom requirements. It handles the difficult “power cross” requirements with less stress than other TVS devices while providing the total protection needed.

## SURGE PROTECTOR MODULES

### TYPES OF SURGE PROTECTOR MODULES

Several component technologies have been implemented either singly or in combination in surge protector modules and devices. The simplest surge protectors contain nothing more than a single transient voltage suppression (TVS) component in a larger package. Others contain two or more in a series, parallel or series-parallel arrangement. Still others contain two or more varieties of TVS elements in combination, providing multiple levels of protection.

Many surge protectors contain non-semiconductor elements such as carbon blocks and varistors. If required, other modes of protection components may be incorporated, such as circuit breakers or EMI noise filters.

Surge protector modules are one solution to the overvoltage problem. Alternatives include:

- Uninterruptible power systems (UPS), whose main duty is to provide power during a blackout, but secondarily provide protection from surges, sags and spikes.
- Power line conditioners, which are designed to isolate equipment from raw utility power and regulated voltages within narrow limits.

Both UPS and power line conditioners are far more expensive than surge protector modules.

**THE 6 MAJOR CATEGORIES OF SURGE PROTECTION MODULES**

- Plug-in
- Hardwired
- Utility
- Datacom
- Telecom
- RF and microwave

**PLUG-IN MODULES**

Plug-in modules come in a variety of sizes and shapes, and are intended for general purpose use. They permit the protection of vulnerable electronic equipment, such as home computers, from overvoltage transients on the 115 vac line. These products are sold in retail outlets, computer stores and via mail order. Most models incorporate a circuit breaker or fuse, and an on/off switch with a neon indicator. The module may have any number of receptacles, with common models having from two to six. These products comply with **UL 1449**, and are generally rated to withstand the application of multiple transients, as specified in **IEEE 587**. Plug-in modules generally provide their protection through the use of these devices which are typically connected between line and neutral, and between neutral and ground.

**HARDWIRED**

Hardwired modules take on a wide variety of styles, depending upon their designed application. They provide protection for instrumentation, computers, automatic test equipment, industrial controls, motor controls, and for certain telecom situations.

Many of these modules provide snubbing networks employing resistors and capacitors to produce an RC time constant. Snubbers provide common mode and differential mode low-pass filtering to reduce interference from line to equipment, and are effective in reducing equipment generated noise from being propagated onto the line. Snubbers leak current however, and many of these modules are designed with heat sinks and require mounting to a chassis. The surge protection is performed in a similar manner to the plug-in modules mentioned earlier. Hardwired

products, therefore, present a prime opportunity for avalanche TVS components.

**UTILITY**

The power transmission and distribution equipment industry has an obvious need for heavy duty protection against overvoltage transients. Many utility situations require a combination of techniques to provide the necessary solution to their particular problems. This industry utilizes many forms of transient suppression outside the realm of semiconductors.

**DATACOM**

Local area networks and other computer links require protection against high energy transients originating on their data lines. In addition, transients on adjacent power lines produce electromagnetic fields that can be coupled onto unprotected signal lines. Datacom protectors have a ground terminal or pigtail which must be tied to the local equipment ground with as short a lead as possible. Datacom protectors should be installed on both ends of a data link, or at all nodes in a network. This protection is in addition to the ac line transient protection, which is served by the plug-in or hardwired protection modules. Some datacom protector modules contain multi-stage hybrid circuits, specially tailored for specific applications, such as 4–20 mA analog current loops.

**TELECOM**

Included here are devices used to protect central office and station telecommunications (telecom) equipment against voltage surges. None of these devices are grounded through an ac power receptacle. Those that are grounded through an ac power receptacle are categorized as plug-in modules. Not only can overvoltages cause disruptions of telecom service, but they can destroy the sophisticated equipment connected to the network. Also, users or technicians working on the equipment can be injured should lightning strike nearby. It is estimated that 10 to 15 people are killed in the U.S. each year while talking on the telephone during lightning storms. For these reasons, surge protectors are used both in central offices and in customer premises.

There are three types of telecom surge protectors now in service: air-gap carbon block, gas tube, and solid state. The desire of the telecom market is to convert as many of the non-solid state implementations into solid state as cost will permit.

**SELECTING TVS COMPONENTS**

From the foregoing discussion it should be clear that the silicon junction avalanche diode offers more desirable characteristics than any other TVS component. Its ability to clamp fast rising transients without overshoot, low clamping factor, non-latching behavior, and lack of a wearout mechanism are the overriding considerations. Its one-shot surge capability is lower than most other TVS devices but is normally adequate for the application. Should an unusually severe event occur, it will short yet still protect the equipment.

For example, an RS-232 data line is specified to operate with a maximum signal level of  $\pm 25$  V. Failure analysis studies<sup>11</sup> have shown that the transmitters and receivers used on RS-232 links tolerate 40 V transients. A 1.5KE27CA diode will handle the maximum signal level while holding the peak transient voltage to less than 40 V with a 40 A 10/1000 pulse which is adequate for all indoor and most outdoor data line runs. As a practical matter, few data links use 25 V signals; 5 V is most common. Consequently, much lower voltage silicon diodes may be used which will allow a corresponding increase in surge current capability. For example, a 10 V breakdown device from the same 1500 W family will clamp to under 15 V (typically 12 V) when subjected to a 100 A pulse.

Telecommunications lines which must accommodate the ring voltage have much more severe requirements. For example, one specification<sup>11</sup> from Bellcore suggests that leakage current be under 20 mA over the temperature range from  $-40^{\circ}\text{C}$  to  $+65^{\circ}\text{C}$  with 265 V peak ac applied. To meet this specification using Zener TVS parts, devices must be stacked. Devices which breakdown at 160 V are chosen to accommodate tolerances and the temperature coefficient. A part number with a 10% tolerance on breakdown could supply a unit which breaks down at 144 V. At  $-40^{\circ}\text{C}$  breakdown could be 133 V. The breakdown of two devices stacked just barely exceeds the worst case ring peak of 265 V. A 1500 W unit has a surge capability of 6.5 A (10/1000) which is too low to be satisfactory while higher power units are too expensive as a rule.

Another problem which telephone line service presents to a surge suppressor is survival during a power cross. An avalanche diode is impractical to use because the energy delivered by a power cross will produce diode failure before any overcurrent protective element can react.

As indicated by the Bell South studies, the thyristor TVS is ideal for telephone line applications. Suppliers offer unidirectional and bidirectional units which meet the FCC impulse wave requirements as shown in Table 1. In addition, the thyristor can handle several cycles of 50/60 Hz power before failure. The Motorola MKT1V200 series, for example, can handle 10 A for 4 cycles, which is enough time for a low current fuse or other current activated protective device to react.

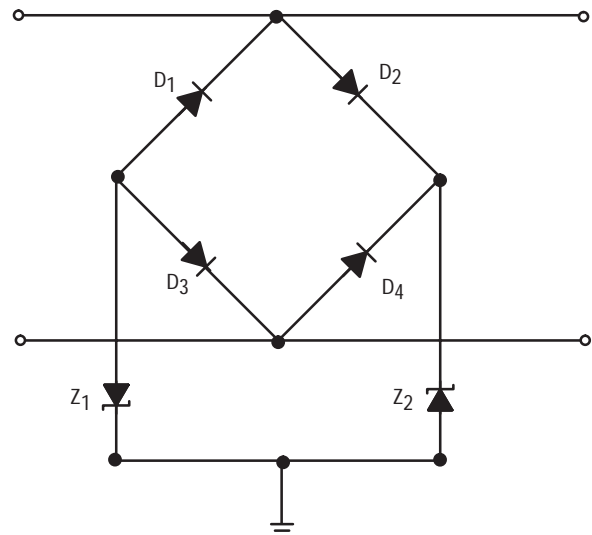
### APPLICATION CONSIDERATIONS

In most cases, it is not advisable to place a zener TVS directly across a data line because of its relatively high capacitance. The arrangement previously discussed and shown in Figure 21 works well for an unbalanced line such as RS-232. When using discrete steering diodes, they should have low capacitance and low turn-on impedance to avoid causing an overshoot on the clamped voltage level.

Most noise and transient surge voltages occur on lines with respect to ground. A signal line such as RS-232 which uses ground as a signal reference is thus very vulnerable to noise and transients. It is, however, easy to protect using a single TVS at each end of the line.

Telephone and RS-422 lines are called balanced lines because the signal is placed between two lines which are "floating" with respect to ground. A signal appears between each signal line and ground but is rejected by the receiver; only the difference in potential between the two signal lines is recognized as the transmitted signal. This system has been in use for decades as a means of providing improved noise immunity, but protection from transient surge voltages is more complex.

A cost-effective means of protecting a balanced line is shown in Figure 23. The bridge diode arrangement allows protection against both positive and negative transients to be achieved, an essential requirement but the TVS devices  $Z_1$  and  $Z_2$  need only be unidirectional. The diodes are chosen to have low capacitance to reduce loading on the line and low turn-on impedance to avoid causing an overshoot on the clamped voltage level. Although a zener TVS is shown, a TSS is more appropriate when a telephone line having ring voltages is to be protected.



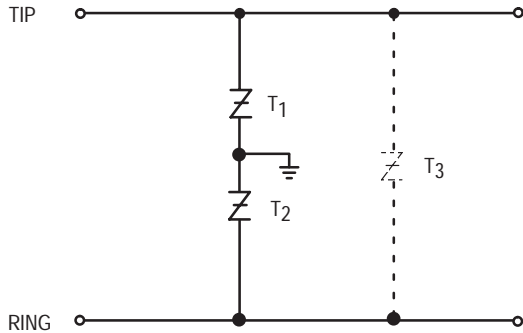
**Figure 23. A Method of Reducing Capacitance and Protecting a Balanced Line**

Since transients are usually common-mode, it is important that the TVS circuit operate in a balanced fashion; otherwise, common mode transients can cause differential mode disturbances which can be devastating to the line receiver. For example, suppose that an identical positive common mode surge voltage appears from each line-to-ground. Diodes  $D_2$  and  $D_4$  will conduct the transients to  $Z_2$ . However, if one of these diodes has a slower turn-on or higher dynamic impedance than the other, the voltage difference caused by the differing diode response appears across the signal lines. Consequently, the bridge diodes must be chosen to be as nearly identical as possible.

Should a differential mode transient appear on the signal lines, it will be held to twice that of the line-to-ground clamping level. In many cases a lower clamping level is needed which can be achieved by placing another TVS across the signal

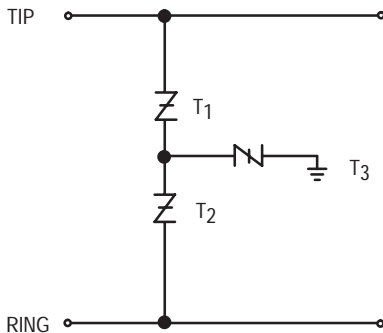
lines. It must be a bidirectional low capacitance device. With a line-to-line TVS in the circuit diode matching is not required.

Other schemes appearing in the literature use two bidirectional TVS devices from each line-to-ground as shown in Figure 24 that of the line-to-ground voltage. To avoid generating a differential mode signal, the TVS must be closely matched or a third TVS must be placed line-to-line. By using a third TVS differential mode transients can be held to a low level.



**Figure 24. Protecting a Balanced Line with Bidirectional TSS Devices**

The arrangement of Figure 25 offers the advantage of lower capacitance when differential mode transient protection is required. If all three TSS devices have the same capacitance (C), the line-to-line and line-to-ground capacitance of Figure 24 is 1.5C. However, the arrangement of Figure 25 exhibits a capacitance of only C/2. To design the circuit to handle the same simultaneous common mode energy as the circuit of Figure 24, T3 must be twice as large as T1 and T2. In this case the capacitance of T3 is doubled which causes the line-to-ground capacitance to be 2C/3, still a considerable improvement over the arrangement of Figure 24.



**Figure 25. Preferred Method of Protecting a Balanced Line Using Bidirectional TSS Devices**

Protectors are usually designed to be “fail safe” if their energy ratings are exceeded, but the definition of “fail safe” is often dependent upon the application. The most common requirement is that the surge voltage protective element should fail short and remain shorted regardless of the

resulting current flow. To insure that this occurs, semiconductor devices use heavy gauge clips or bonding wires between the chip and terminals. In addition, parts are available in plastic packages having a spring type shorting bar which shorts the terminals when the package softens at the very high temperatures generated during a severe overload.

The shorted TVS protects the equipment, but the line feeding it could be destroyed if the source of energy which shorted the TVS is from a power cross. Therefore, it is wise and necessary for a UL listing to provide a series element such as a fuse or PTC device to either open the circuit or restrict its value to a safe level.

The design of circuit boards is critical and layout must be done to minimize any lead or wiring inductance in series with the TVS. Significant voltage is developed in any loop subject to transients because of their high current amplitudes and fast risetimes.

**REFERENCES**

1. D. W. Bodle and P. A. Gresh, “Lightning Surges in Paired Telephone Cable Facilities,” *The Bell System Technical Journal*, Vol. 4, March 1961, pp. 547–576.
2. D. G. Stroh, “Static Electricity Can Kill Transistors,” *Electronics*, Vol. 35, 1962, pp. 90–91.
3. J. D. Norgard and C. L. Chen, “Lightning-Induced Transients on Buried Shielded Transmission Lines,” *IEEE Transactions on EMC*, Vol. EMC28, No. 3, August 1986, pp. 168–171.
4. O. M. Clark, “Transient Voltage Suppression (TVS),” 1989, pp. 6–7.
5. Clark, p. 7.
6. World Information Technologies, “U. S. Electrical and Electronic Surge Protection Markets,” 1989, p. 5.
7. T. J. Tucker, “Spark Initiation Requirements of a Secondary Explosive,” *Annals of the New York Academy of Sciences*, Vol. 152, Article I, 1968, pp. 643–653.
8. H. K. Florig, “The Future Battlefield: A Blast of Gigawatts?,” *IEEE Spectrum*, Vol. 25, No. 3, March 1988, pp. 50–54.
9. Mel Thrasher, “A Solid State Solution,” *Telephony*, June 1989, pp. 48–52.
10. A. Urbieta, “Sensitivity Study to EOS/SSD of Bipolar Integrated Circuits,” *EOS-8*, 1986.
11. M. Tetreault and F.D. Martzloff, “Characterization of Disturbing Transient Waveforms on Computer Data Communication Lines,” *EMC Proceedings, Zurich*, March 1985, pp. 423–428.
12. F. Martzloff, “Coupling, Propagation, and Side Effects of Surges in an Industrial Building Wiring System,” *Conference Record of IEEE IAS Meeting*, 1988, pp. 1467–1475.



## IMPORTANT REGULATORY REQUIREMENTS AND GUIDELINES

### GENERAL

**DOD-STD-1399, MIL-STD-704, MIL-STD-1275, MIL-STD-461C.** These military specifications are important, if we intend to target devices for military or commercial aviation markets.

**IEEE 587.** This specification describes multiple transient waveforms.

**UL1449.** This is a compulsory test which demonstrates performance to criteria establishing the maximum voltage that can pass through a device after clamping has taken place. It is important that we comply, and say so on our data sheets.

### INDUSTRIAL

**ANSI/IEEE C62.41.** Established by the American National Standards Institute (ANSI) and the Institute of Electrical and Electronic Engineers (IEEE), this guideline tests the effectiveness of devices to typical power disturbances. To meet the most rigorous category of this spec, a device or module must be capable of withstanding a maximum repetitive surge current pulse of 3000 amps with a 8/20  $\mu$ s waveform.

**IEC TC 102 D.** Requirements for remote control receivers for industrial applications are detailed in this International Electrotechnical Commission (IEC) document.

**IEC 255-4 and IEC TC 41.** These documents describe testing for static relays for industrial use.

**IEC 801-1 thru -3.** These are specifications for various industrial control applications.

**IEC 801-4.** The IEC specifies transient voltage impulses which occur from the switching of inductive loads. We must be aware of the importance of this specification, especially in Europe, and characterize our devices' performance to it.

**IEEE 472/ANSI C 37.90.1.** Requirements for protective relays, including 10/1000 nS waveform testing is described.

**UL943.** This requirement defines a 0.5  $\mu$ s/100 kHz waveform for ground fault and other switching applications.

**VDE 0420.** Industrial remote control receivers are detailed, and test procedures defined.

**VDE 0860/Part 1/II.** This includes a description of 0.2/200  $\mu$ s, 10kV test requirements.

### TELECOM

**CCITT IX K.17, K.20, K.15.** These documents relate to repeaters.

**EIA PM-1361.** This document covers requirements for telephone terminals and data processing equipment.

**FTZ 4391 TV1.** This is a general German specification for telecom equipment.

**FCC Part 68.** The Federal Communications Commission (FCC) requirements for communications equipment is defined. Of special note is **§68.302**, dealing with telecom power lines.

**NT/DAS/PRL/003.** Telephone instrument, subscriber equipment and line requirements are documented.

**PTT 692.01.** This is a general Swiss specification for telecom exchange equipment.

**REA PE-60.** The Rural Electrification Administration (REA) has documented the predominant waveform for induced lightning transients. This test is now commonly known as the 10/1000  $\mu$ s pulse test.

**REA PE-80.** The REA defines requirements for gas tubes and similar devices for telecom applications.

**TA-TSY-000974.** This technical advisory by Bellcore defines double exponential waveforms, which are the basis for many telecom applications norms.

**UL 1459 and UL 4978.** These document detail tests for standard telephone equipment and data transmission.

**TA-TSY-000974.** This technical advisory by Bellcore defines double exponential waveforms, which are the basis for many telecom applications norms.

**UL 1459 and UL 4978.** These document detail tests for standard telephone equipment and data transmission.

# Chapter 11

## AN784 — TRANSIENT POWER CAPABILITY OF ZENER DIODES

Prepared by  
Applications Engineering and  
Jerry Wilhardt, Product Engineer — Industrial and Hi-Rel Zener Diodes

### INTRODUCTION

Because of the sensitivity of semiconductor components to voltage transients in excess of their ratings, circuits are often designed to inhibit voltage surges in order to protect equipment from catastrophic failure. External voltage transients are imposed on power lines as a result of lightning strikes, motors, solenoids, relays or SCR switching circuits, which share the same ac source with other equipment. Internal transients can be generated within a piece of equipment by rectifier reverse recovery transients, switching of loads or transformer primaries, fuse blowing, solenoids, etc. The basic relation,  $v = L di/dt$ , describes most equipment developed transients.

### ZENER DIODE CHARACTERISTICS

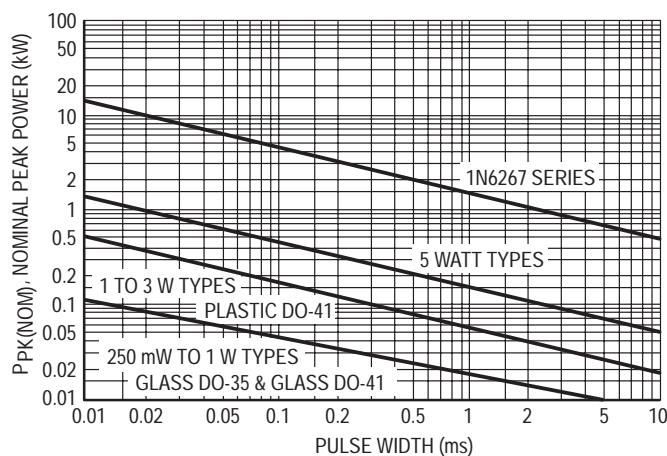
Zener diodes, being nearly ideal clippers (that is, they exhibit close to an infinite impedance below the clipping level and close to a short circuit above the clipping level), are often used to suppress transients. In this type of application, it is important to know the power capability of the zener for short pulse durations, since they are intolerant of excessive stress.

Some Motorola data sheets such as the ones for devices shown in Table 1 contain short pulse surge capability. However, there are many data sheets that do not contain this data and Figure 1 is presented here to supplement this information.

Table 1. Transient Suppressor Diodes			
Series Numbers	Steady State Power	Package	Description
1N4728	1 W	DO-41	Double Slug Glass
1N6267	5 W	Case 41A	Axial Lead Plastic
1N5333A	5 W	Case 17	Surmetic 40
1N746/957 A/4371	400 mW	DO-35	Double Slug Glass
1N5221A	500 mW	DO-35	Double Slug Glass

Some data sheets have surge information which differs slightly from the data shown in Figure 1. A variety of reasons exist for this:

1. The surge data may be presented in terms of actual surge power instead of nominal power.
2. Product improvements have occurred since the data sheet was published.



Power is defined as  $V_Z(NOM) \times I_Z(PK)$  where  $V_Z(NOM)$  is the nominal zener voltage measured at the low test current used for voltage classification.

**Figure 1. Peak Power Ratings of Zener Diodes**

3. Larger dice are used, or special tests are imposed on the product to guarantee higher ratings than those shown on Figure 1.

4. The specifications may be based on a JEDEC registration or part number of another manufacturer.

The data of Figure 1 applies for non-repetitive conditions and at a lead temperature of 25°C. If the duty cycle increases, the peak power must be reduced as indicated by the curves of Figure 2. Average power must be derated as the lead or ambient temperature rises above 25°C. The average power derating curve normally given on data sheets may be normalized and used for this purpose.

At first glance the derating curves of Figure 2 appear to be in error as the 10 ms pulse has a higher derating factor than the 10 μs pulse. However, when the derating factor for a given pulse of Figure 2 is multiplied by the peak power value of Figure 1 for the same pulse, the results follow the expected trend.

When it is necessary to use a zener close to surge ratings, and a standard part having guaranteed surge limits is not suitable, a special part number may be created having a surge limit as part of the specification. Contact your nearest Motorola OEM sales office for capability, price, delivery, and minimum order criteria.

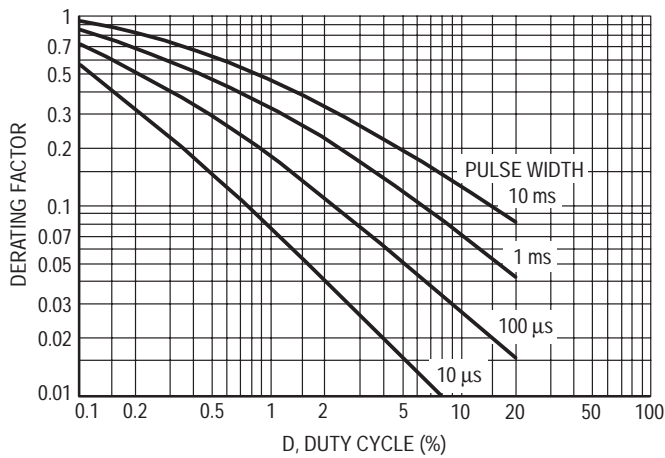


Figure 2. Typical Derating Factor for Duty Cycle

### MATHEMATICAL MODEL

Since the power shown on the curves is not the actual transient power measured, but is the product of the peak current measured and the nominal zener voltage measured at the current used for voltage classification, the peak current can be calculated from:

$$I_{Z(PK)} = \frac{P(PK)}{V_Z(NOM)} \quad (1)$$

The peak voltage at peak current can be calculated from:

$$V_Z(PK) = F_C \times V_Z(NOM) \quad (2)$$

where  $F_C$  is the clamping factor. The clamping factor is approximately 1.20 for all zener diodes when operated at their pulse power limits. For example, a 5 watt, 20 volt zener can be expected to show a peak voltage of 24 volts regardless of whether it is handling 450 watts for 0.1 ms or 50 watts for 10 ms. This occurs because the voltage is a function of junction temperature and IR drop. Heating of the junction is more severe at the longer pulse width, causing a higher voltage component due to temperature which is roughly offset by the smaller IR voltage component.

For modeling purposes, an approximation of the zener resistance is needed. It is obtained from:

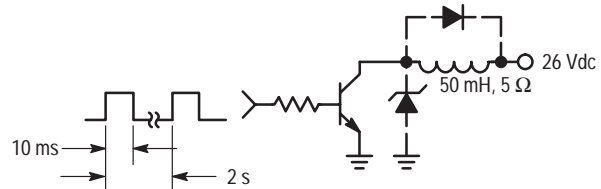
$$R_{Z(NOM)} = \frac{V_Z(NOM)(F_C - 1)}{P_{PK(NOM)}/V_Z(NOM)} \quad (3)$$

The value is approximate because both the clamping factor and the actual resistance are a function of temperature.

### CIRCUIT CONSIDERATIONS

It is important that as much impedance as circuit constraints allow be placed in series with the zener diode and the components to be protected. The result will be a lower clipping voltage and less zener stress. A capacitor in parallel with the zener is also effective in reducing the stress imposed by very short duration transients.

To illustrate use of the data, a common application will be analyzed. The transistor in Figure 3 drives a 50 mH solenoid which requires 5 amperes of current. Without some means of clamping the voltage from the inductor when the transistor turns off, it could be destroyed.



Used to select a zener diode having the proper voltage and power capability to protect the transistor.

Figure 3. Circuit Example

The means most often used to solve the problem is to connect an ordinary rectifier diode across the coil; however, this technique may keep the current circulating through the coil for too long a time. Faster switching is achieved by allowing the voltage to rise to a level above the supply before being clamped. The voltage rating of the transistor is 60 V, indicating that approximately a 50 volt zener will be required.

The peak current will equal the on-state transistor current (5 amperes) and will decay exponentially as determined by the coil L/R time constant (neglecting the zener impedance). A rectangular pulse of width L/R (0.01 sec) and amplitude of  $I_{PK}$  (5 A) contains the same energy and may be used to select a zener diode. The nominal zener power rating therefore must exceed  $(5 A \times 50) = 250$  watts at 10 ms and a duty cycle of  $0.01/2 = 0.5\%$ . From Figure 2, the duty cycle factor is 0.62 making the single pulse power rating required equal to  $250/0.62 = 403$  watts. From Figure 1, one of the 1N6267 series zeners has the required capability. The 1N6287 is specified nominally at 47 volts and should prove satisfactory.

Although this series has specified maximum voltage limits, equation 3 will be used to determine the maximum zener voltage in order to demonstrate its use.

$$R_Z = \frac{47(1.20 - 1)}{500/47} = \frac{9.4}{10.64} = 0.9\Omega$$

At 5 amperes, the peak voltage will be 4.5 volts above nominal or 51.5 volts total which is safely below the 60 volt transistor rating.

# AN843 — A REVIEW OF TRANSIENTS AND THEIR MEANS OF SUPPRESSION

Prepared by  
Steve Cherniak  
Applications Engineering

## INTRODUCTION

One problem that most, if not all electronic equipment designers must deal with, is transient overvoltages. Transients in electrical circuits result from the sudden release of previously stored energy. Some transients may be voluntary and created in the circuit due to inductive switching, commutation voltage spikes, etc. and may be easily suppressed since their energy content is known and predictable. Other transients may be created outside the circuit and then coupled into it. These can be caused by lightning, substation problems, or other such phenomena. These transients, unlike switching transients, are beyond the control of the circuit designer and are more difficult to identify, measure and suppress.

Effective transient suppression requires that the impulse energy is dissipated in the added suppressor at a low enough voltage so the capabilities of the circuit or device will not be exceeded.

## REOCCURRING TRANSIENTS

Transients may be formed from energy stored in circuit inductance and capacitance when electrical conditions in the circuit are abruptly changed.

Switching induced transients are a good example of this; the change in current ( $\frac{di}{dt}$ ) in an inductor (L) will generate

a voltage equal to  $L \frac{di}{dt}$ . The energy (J) in the transient is equal to  $1/2Li^2$  and usually exists as a high power impulse for a relatively short time ( $J = Pt$ ).

If load 2 is shorted (Figure 1), devices parallel to it may be destroyed. When the fuse opens and interrupts the fault current, the slightly inductive power supply produces a transient voltage spike of  $V = L \frac{di}{dt}$  with an energy content of  $J = 1/2Li^2$ . This transient might be beyond the voltage limitations of the rectifiers and/or load 1. Switching out a high current load will have a similar effect.

## TRANSFORMER PRIMARY BEING ENERGIZED

If a transformer is energized at the peak of the line voltage (Figure 2), this voltage step function can couple to the stray capacitance and inductance of the secondary winding and generate an oscillating transient voltage whose oscillations depend on circuit inductance and capacitance. This transient's peak voltage can be up to twice the peak amplitude of the normal secondary voltage.

In addition to the above phenomena the capacitively coupled ( $C_S$ ) voltage spike has no direct relationship with the turns ratio, so it is possible for the secondary circuit to see the peak applied primary voltage.

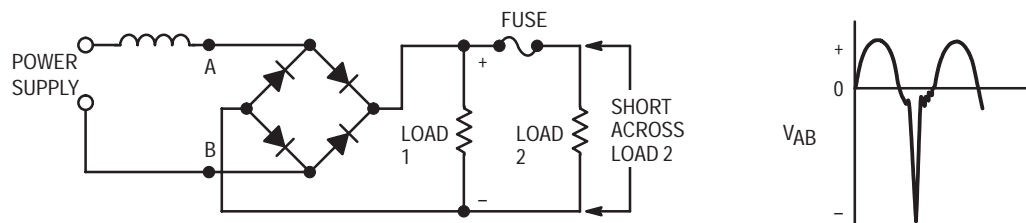


Figure 1. Load Dump with Inductive Power Supply

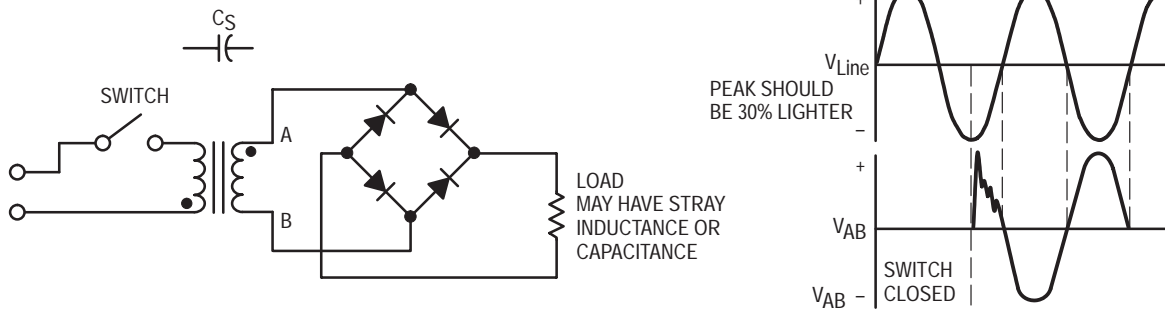


Figure 2. Situation Where Transformer Capacitance Causes a Transient

**TRANSFORMER PRIMARY BEING DE-ENERGIZED**

If the transformer is driving a high impedance load, transients of more than ten times normal voltage can be created at the secondary when the primary circuit of the transformer is opened during zero-voltage crossing of the ac line. This is due to the interruption of the transformer magnetizing current which causes a rapid collapse of the magnetic flux in the core. This, in turn, causes a high voltage transient to be coupled into the transformer's secondary winding (Figure 3).

Transients produced by interrupting transformers magnetizing current can be severe. These transients can destroy a rectifier diode or filter capacitor if a low impedance discharge path is not provided.

**SWITCH "ARCING"**

When a contact type switch opens and tries to interrupt current in an inductive circuit, the inductance tries to keep current flowing by charging stray capacitances. (See Figure 4.)

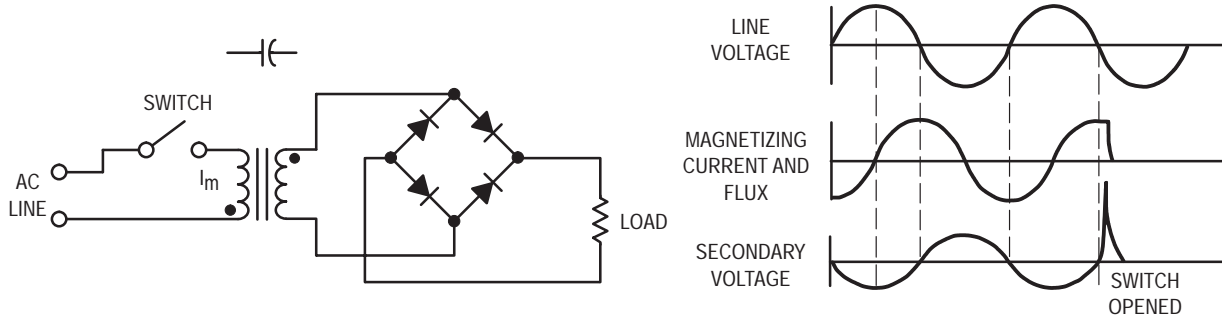


Figure 3. Typical Situation Showing Possible Transient When Interrupting Transformer Magnetizing Current

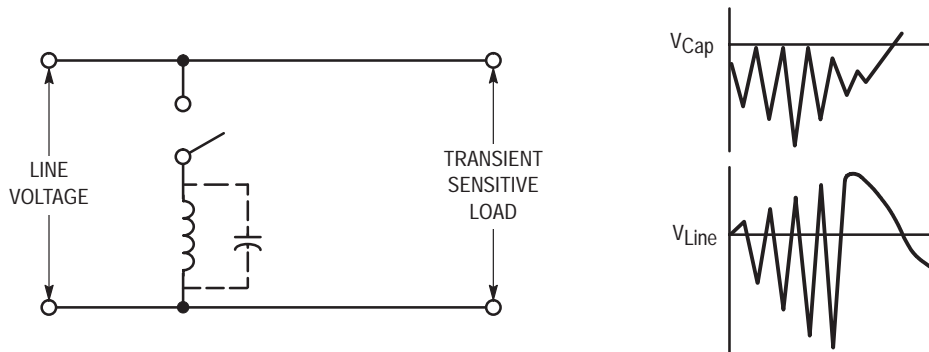


Figure 4. Transients Caused by Switch Opening

This can also happen when the switch contacts bounce open after its initial closing. When the switch is opened (or bounces open momentarily) the current that the inductance wants to keep flowing will oscillate between the stray capacitance and the inductance. When the voltage due to the oscillation rises at the contacts, breakdown of the contact gap is possible, since the switch opens (or bounces open) relatively slowly compared to the oscillation frequency, and the distance may be small enough to permit "arcing." The arc will discontinue at the zero current point of the oscillation, but as the oscillatory voltage builds up again and the contacts move further apart, each arc will occur at a higher voltage until the contacts are far enough apart to interrupt the current.

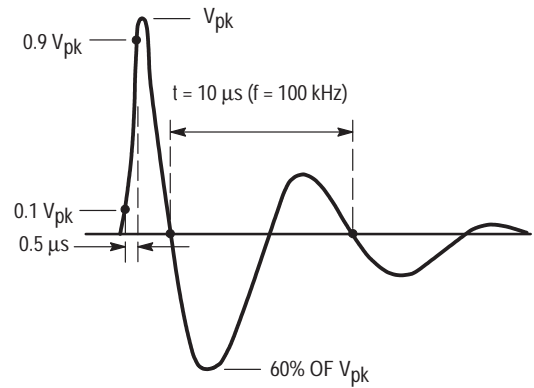
**WAVESHAPES OF SURGE VOLTAGES**

**Indoor Waveshapes**

Measurements in the field, laboratory, and theoretical calculations indicate that the majority of surge voltages in indoor low-voltage power systems have an oscillatory waveshape. This is because the voltage surge excites the natural resonant frequency of the indoor wiring system. In addition to being typically oscillatory, the surges can also have different amplitudes and waveshapes in the various places of the wiring system. The resonant frequency can range from about 5 kHz to over 500 kHz. A 100 kHz frequency is a realistic value for a typical surge voltage for most residential and light industrial ac wire systems.

The waveshape shown in Figure 5 is known as an "0.5 μs – 100 kHz ring wave." This waveshape is reasonably representative of indoor low-voltage (120 V – 240 V) wiring system transients based on measurements conducted by several independent organizations. The waveshape is defined as rising from 10% to 90% of its final amplitude in 0.5 μs, then decays while oscillating at 100 kHz, each peak being 60% of the preceding one.

The fast rise portion of the waveform can induce the effects associated with non-linear voltage distribution in windings or cause dv/dt problems in semiconductors. Shorter rise times can be found in transients but they are lengthened as they propagate into the wiring system or reflected from wiring discontinuities.



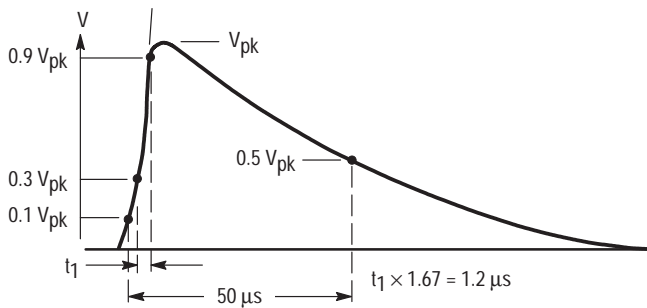
**Figure 5. 0.5 μs 100 kHz Ring Wave**

The oscillating portion of the waveform produces voltage polarity reversal effects. Some semiconductors are sensitive to polarity changes or can be damaged when forced into or out of conduction (i.e. reverse recovery of rectifier devices). The sensitivity of some semiconductors to the timing and polarity of a surge is one of the reasons for selecting this oscillatory waveform to represent actual conditions.

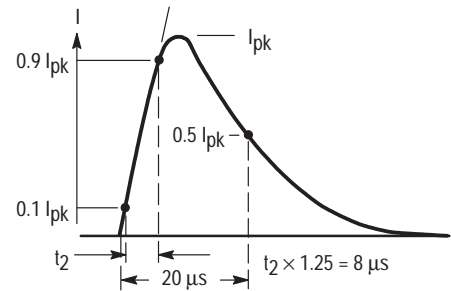
**Outdoor Locations**

Both oscillating and unidirectional transients have been recorded in outdoor environments (service entrances and other places nearby). In these locations substantial energy is still available in the transient, so the waveform used to model transient conditions outside buildings must contain greater energy than one used to model indoor transient surges.

Properly selected surge suppressors have a good reputation of successful performance when chosen in conjunction with the waveforms described in Figure 6. The recommended waveshape of  $1.2 \times 50 \mu s$  ( $1.2 \mu s$  is associated with the transients rise time and the  $50 \mu s$  is the time it takes for the voltage to drop to  $1/2V_{pk}$ ) for the open circuit voltage and  $8 \times 20 \mu s$  for the short circuit current are as defined in IEEE standard 28-ANSI Standard C62.1 and can be considered a realistic representation of an outdoor transients waveshape.



**(a) Open-Circuit Voltage Waveform**



**(b) Discharge Current Waveform**

**Figure 6. Unidirectional Wave Shapes**

The type of device under test determines which waveshape in Figure 6 is more appropriate. The voltage waveform is normally used for insulation voltage withstand tests and the current waveform is usually used for discharge current tests.

**RANDOM TRANSIENTS**

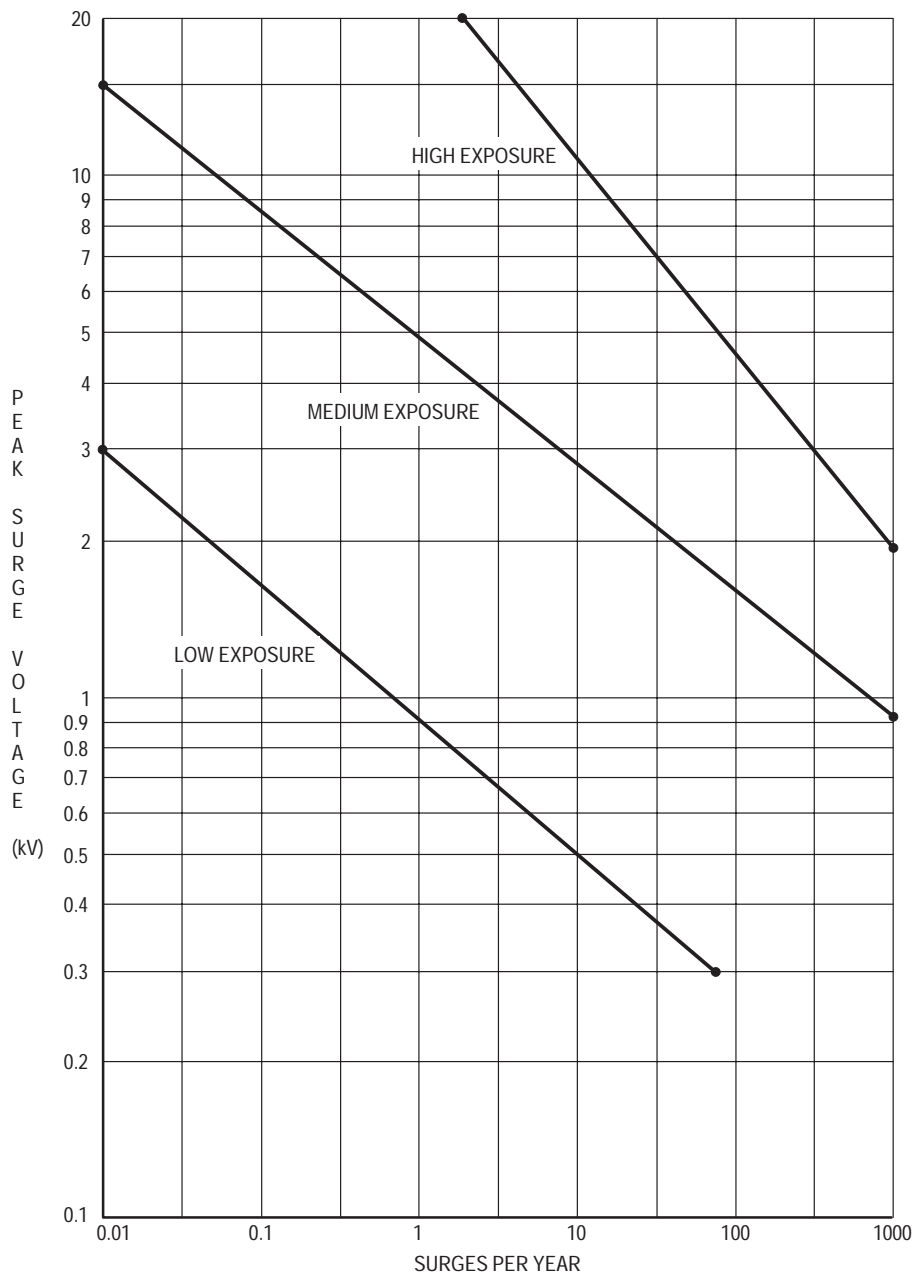
The source powering the circuit or system is frequently the cause of transient induced problems or failures. These transients are difficult to deal with due to their nature; they are totally random and it is difficult to define their amplitude, duration and energy content. These transients are generally caused by switching parallel loads on the same branch of

a power distribution system and can also be caused by lightning.

**AC POWER LINE TRANSIENTS**

Transients on the ac power line range from just above normal voltage to several kV. The rate of occurrence of transients varies widely from one branch of a power distribution system to the next, although low-level transients occur more often than high-level surges.

Data from surge counters and other sources is the basis for the curves shown in Figure 7. This data was taken from unprotected (no voltage limiting devices) circuits meaning that the transient voltage is limited only by the sparkover distance of the wires in the distribution system.



**Figure 7. Peak Surge Voltage versus Surges per Year\***

\*EIA paper, P587.1/F, May, 1979, Page 10

The low exposure portion of the set of curves is data collected from systems with little load-switching activity that are located in areas of light lightning activity.

Medium exposure systems are in areas of frequent lightning activity with a severe switching transient problem.

High exposure systems are rare systems supplied by long overhead lines which supply installations that have high sparkover clearances and may be subject to reflections at power line ends.

When using Figure 7 it is helpful to remember that peak transient voltages will be limited to approximately 6 kV in indoor locations due to the spacing between conductors using standard wiring practices.

### TRANSIENT ENERGY LEVELS AND SOURCE IMPEDANCE

The energy contained in a transient will be divided between the transient suppressor and the source impedance of the transient in a way that is determined by the two impedances. With a spark-gap type suppressor, the low impedance of the Arc after breakdown forces most of the transient's energy to be dissipated elsewhere, e.g. in a current limiting resistor in series with the spark-gap and/or in the transient's source impedance. Voltage clamping suppressors (e.g. zeners, mov's, rectifiers operating in the breakdown region) on the other hand absorb a large portion of the transient's surge energy. So it is necessary that a realistic assumption of the transient's source impedance be made in order to be able to select a device with an adequate surge capability.

The 100 kHz "Ring Wave" shown in Figure 5 is intended to represent a transient's waveshape across an open circuit. The waveshape will change when a load is connected and the amount of change will depend on the transient's source impedance. The surge suppressor must be able to withstand the current passed through it from the surge source. An assumption of too high a surge impedance (when testing the suppressor) will not subject the device under test to sufficient stresses, while an assumption of too low a surge impedance may subject it to an unrealistically large stress; there is a trade-off between the size (cost) of the suppressor and the amount of protection obtained.

In a building, the transient's source impedance increases with the distance from the electrical service entrance, but open circuit voltages do not change very much throughout the structure since the wiring does not provide much attenuation. There are three categories of service locations that can represent the majority of locations from the electrical service entrance to the most remote wall outlet. These are listed below. Table 1 is intended as an aid for the preliminary selection of surge suppression devices, since it is very difficult to select a specific value of source impedance.

Category I: Outlets and circuits a "long distance" from electrical service entrance. Outlets more than 10 meters from Category II or more than 20 meters from Category III (wire gauge #14 – #10)

Category II: Major bus lines and circuits a "short distance" from electrical service entrance. Bus system in industrial plants. Outlets for heavy duty appliances that are "close" to the service entrance.

Distribution panel devices.

Commercial building lighting systems.

Category III. Electrical service entrance and outdoor locations.

Power line between pole and electrical service entrance.

Power line between distribution panel and meter.

Power line connection to additional near-by buildings.

Underground power lines leading to pumps, filters, etc.

Categories I and II in Table 1 correspond to the extreme range of the "medium exposure" curve in Figure 7. The surge voltage is limited to approximately 6 kV due to the sparkover spacing of indoor wiring.

The discharge currents of Category II were obtained from simulated lightning tests and field experience with suppressor performance.

The surge currents in Category I are less than in Category II because of the increase in surge impedance due to the fact that Category I is further away from the service entrance.

Category III can be compared to the "High Exposure" situation in Figure 7. The limiting effect of sparkover is not available here so the transient voltage can be quite large.

**Table 1. Surge Voltages and Currents Deemed to Represent the Indoor Environment Depending Upon Location**

Category	Waveform	Surge Voltage(1)	Surge Current(2)	Energy (Joules) Dissipated in a Suppressor with a Clamping Voltage of (3)		
				250 V	500 V	1000 V
I	0.5 $\mu$ s 100 kHz Ring Wave	6 kV	200 A	0.4	0.8	1.6
II	0.5 $\mu$ s 100 kHz Ring Wave	6 kV	500 A	1	2	4
		6 kV	3 kA	20	40	80
III	1.2 $\times$ 50 $\mu$ s 8 $\times$ 20 $\mu$ s	10 kV or more	10 kA or more			

Notes: 1. Open Circuit voltage

2. Discharge current of the surge (not the short circuit current of the power system)

3. The energy a suppressor will dissipate varies in proportion with the suppressor's clamping voltage, which can be different with different system voltages (assuming the same discharge current).



## LIGHTNING TRANSIENTS

There are several mechanisms in which lightning can produce surge voltages on power distribution lines. One of them is a direct lightning strike to a primary (before the substation) circuit. When this high current, that is injected into the power line, flows through ground resistance and the surge impedance of the conductors, very large transient voltages will be produced. If the lightning misses the primary power line but hits a nearby object the lightning discharge may also induce large voltage transients on the line. When a primary circuit surge arrester operates and limits the primary voltage the rapid  $dv/dt$  produced will effectively couple transients to the secondary circuit through the capacitance of the transformer (substation) windings in addition to those coupled into the secondary circuit by normal transformer action. If lightning struck the secondary circuit directly, very high currents may be involved which would exceed the capability of conventional surge suppressors. Lightning ground current flow resulting from nearby direct to ground discharges can couple onto the common ground impedance paths of the grounding networks also causing transients.

## AUTOMOTIVE TRANSIENTS

Transients in the automotive environment can range from the noise generated by the ignition system and the various accessories (radio, power window, etc.) to the potentially destructive high energy transients caused by the charging

(alternator/regulator) system. The automotive "Load Dump" can cause the most destructive transients; it is when the battery becomes disconnected from the charging system during high charging rates. This is not unlikely when one considers bad battery connections due to corrosion or other wiring problems. Other problems can exist such as steady state overvoltages caused by regulator failure or 24 V battery jump starts. There is even the possibility of incorrect battery connection (reverse polarity).

Capacitive and/or inductive coupling in wire harnesses as well as conductive coupling (common ground) can transmit these transients to the inputs and outputs of automotive electronics.

The Society of Automotive Engineers (SAE) documented a table describing automotive transients (see Table 2) which is useful when trying to provide transient protection.

Considerable variation has been observed while gathering data on automobile transients. All automobiles have their electrical systems set up differently and it is not the intent of this paper to suggest a protection level that is required. There will always be a trade-off between cost of the suppressor and the level of protection obtained. The concept of one master suppressor placed on the main power lines is the most cost-effective scheme possible since individual suppressors at the various electronic devices will each have to suppress the largest transient that is likely to appear (Load Dump), hence each individual suppressor would have to be the same size as the one master suppressor since it is unlikely for several suppressors to share the transient discharge.

**Table 2. Typical Transients Encountered in the Automotive Environment**

Length of Transient	Cause	Energy Capability	Possible Frequency of Application
		Voltage Amplitude	
Steady State	Failed Voltage Regulator	$\infty$	Infrequent
		+18 V	
5 Minutes	Booster starts with 24 V battery	$\infty$	Infrequent
		$\pm 24$ V	
4.5–100 ms	Load Dump — i.e., disconnection of battery during high charging rates	$\geq 10$ J	Infrequent
		$\leq 125$ V	
$\leq 0.32$ s	Inductive Load Switching Transient	$< 1$ J	Often
		–300 V to +80 V	
$\leq 0.2$ s	Alternator Field Decay	$< 1$ J	Each Turn-Off
		–100 V to –40 V	
90 ms	Ignition Pulse Disconnected Battery	$< 0.5$ J	$\leq 500$ Hz Several Times in vehicle life
		$\leq 75$ V	
1 ms	Mutual Coupling in Harness	$< 1$ J	Often
		$\leq 200$ V	
15 $\mu$ s	Ignition Pulse Normal	$< 0.001$ J	3 500 Hz Continuous
		3 V	
	Accessory Noise	$\leq 1.5$ V	50 Hz to 10 kHz
	Transceiver Feedback	$\approx 20$ mV	R.F.

There will, of course, be instances where a need for individual suppressors at the individual accessories will be required, depending on the particular wiring system or situation.

## TRANSIENT SUPPRESSOR TYPES

### Carbon Block Spark Gap

This is the oldest and most commonly used transient suppressor in power distribution and telecommunication systems. The device consists of two carbon block electrodes separated by an air gap, usually 3 to 4 mils apart. One electrode is connected to the system ground and the other to the signal cable conductor. When a transient over-voltage appears, its energy is dissipated in the arc that forms between the two electrodes, a resistor in series with the gap, and also in the transient's source impedance, which depends on conductor length, material and other parameters.

The carbon block gap is a fairly inexpensive suppressor but it has some serious problems. One is that it has a relatively short service life and the other is that there are large variations in its arcing voltage. This is the major problem since a nominal 3 mil gap will arc anywhere from 300 to 1000 volts. This arcing voltage variation limits its use mainly to primary transient suppression with more accurate suppressors to keep transient voltages below an acceptable level.

### Gas Tubes

The gas tube is another common transient suppressor, especially in telecommunication systems. It is made of two metallic conductors usually separated by 10 to 15 mils encapsulated in a glass envelope which is filled with several gases at low pressure. Gas tubes have a higher current carrying capability and longer life than carbon block gaps. The possibility of seal leakage and the resultant loss of protection has limited the use of these devices.

### Selenium Rectifiers

Selenium transient suppressors are selenium rectifiers used in the reverse breakdown mode to clamp voltage transients. Some of these devices have self-healing properties which allows the device to survive energy discharges greater than their maximum capability for a limited number of surges. Selenium rectifiers do not have the voltage clamping capability of zener diodes. This is causing their usage to become more and more limited.

## METAL OXIDE VARISTORS (MOV'S)

An MOV is a non-linear resistor which is voltage dependent and has electrical characteristics similar to back-to-back zener diodes. As its name implies it is made up of metal oxides, mostly zinc oxide with other oxides added to control electrical characteristics. MOV characteristics are compared to back-to-back zeners in Photos 2 through 7.

When constructing MOV's the metal oxides are sintered at high temperatures to produce a polycrystalline structure

of conductive zinc oxide separated by highly resistive intergranular boundaries. These boundaries are the source of the MOV's non-linear electrical behavior.

MOV electrical characteristics are mainly controlled by the physical dimensions of the polycrystalline structure since conduction occurs between the zinc oxide grains and the intergranular boundaries which are distributed throughout the bulk of the device.

The MOV polycrystalline body is usually formed into the shape of a disc. The energy rating is determined by the device's volume, voltage rating by its thickness, and current handling capability by its area. Since the energy dissipated in the device is spread throughout its entire metal oxide volume, MOV's are well suited for single shot high power transient suppression applications where good clamping capability is not required.

The major disadvantages with using MOV's are that they can only dissipate relatively small amounts of average power and are not suitable for many repetitive applications. Another drawback with MOV's is that their voltage clamping capability is not as good as zeners, and is insufficient in many applications.

Perhaps the major difficulty with MOV's is that they have a limited life time even when used below their maximum ratings. For example, a particular MOV with a peak current handling capability of 1000 A has a lifetime of about 1 surge at 1000  $A_{pk}$ , 100 surges at 100  $A_{pk}$  and approximately 1000 surges at 65  $A_{pk}$ .

## TRANSIENT SUPPRESSION USING ZENERS

Zener diodes exhibit a very high impedance below the zener voltage ( $V_Z$ ), and a very low impedance above  $V_Z$ . Because of these excellent clipping characteristics, the zener diode is often used to suppress transients. Zeners are intolerant of excessive stress so it is important to know the power handling capability for short pulse durations.

Most zeners handle less than their rated power during normal applications and are designed to operate most effectively at this low level. Zener transient suppressors such as the Motorola 1N6267 Mosorb series are designed to take large, short duration power pulses.

This is accomplished by enlarging the chip and the effective junction area to withstand the high energy surges. The package size is usually kept as small as possible to provide space efficiency in the circuit layout, and since the package does not differ greatly from other standard zener packages, the steady state power dissipation does not differ greatly.

Some data sheets contain information on short pulse surge capability. When this information is not available for Motorola devices, Figure 8 can be used. This data applies for non-repetitive conditions with a lead temperature of 25°C.

It is necessary to determine the pulse width and peak power of the transient being suppressed when using Figure 8. This can be done by taking whatever waveform the transient is and approximating it with a rectangular pulse with the same peak power. For example, an exponential

discharge with a 1 ms time constant can be approximated by a rectangular pulse 1 ms wide that has the same peak power as the transient. This would be a better approximation than a rectangular pulse 10 ms wide with a correspondingly lower amplitude. This is because the heating effects of different pulse width lengths affect the power handling capability, as can be seen by Figure 8. This also represents a conservative approach because the exponential discharge will contain  $\approx 1/2$  the energy of a rectangular pulse with the same pulse width and amplitude.

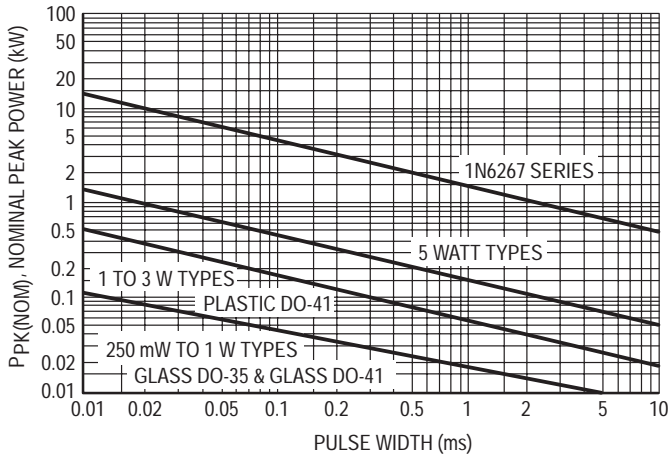


Figure 8. Peak Power Ratings of Zener Diodes

When used in repetitive applications, the peak power must be reduced as indicated by the curves of Figure 9. Average power must be derated as the lead or ambient temperature exceeds 25°C. The power derating curve normally given on data sheets can be normalized and used for this purpose.

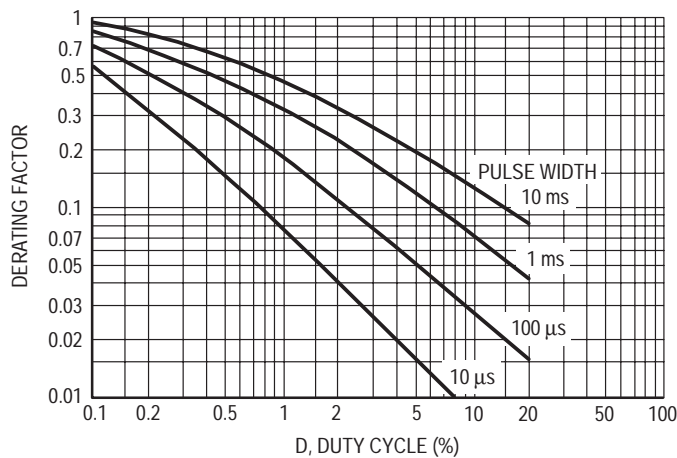


Figure 9. Typical Derating Factor for Duty Cycle

The peak zener voltage during the peak current of the transient being suppressed can be related to the nominal zener voltage (Eqtn 1) by the clamping factor ( $F_C$ ).

$$\text{Eqtn 1: } V_{Z(pK)} = F_C (V_{Z(\text{nom})})$$

Unless otherwise specified  $F_C$  is approximately 1.20 for zener diodes when operated at their pulse power limits.

For example, a 5 watt, 20 volt zener can be expected to show a peak voltage of 24 volts regardless of whether it is handling 450 watts for 0.1 ms or 50 watts for 10 ms. (See Figure 8.)

This occurs because the zener voltage is a function of both junction temperature and IR drop. Longer pulse widths cause a greater junction temperature rise than short ones; the increase in junction temperature slightly increases the zener voltage. This increase in zener voltage due to heating is roughly offset by the fact that longer pulse widths of identical energy content have lower peak currents. This results in a lower IR drop (zener voltage drop) keeping the clamping factor relatively constant with various pulse widths of identical energy content.

An approximation of zener impedance is also helpful in the design of transient protection circuits. The value of  $R_{Z(\text{nom})}$  (Eqtn 2) is approximate because both the clamping factor and the actual resistance is a function of temperature.

$$\text{Eqtn 2: } R_{Z(\text{nom})} = \frac{V_{Z(\text{nom})}^2 (F_C - 1)}{P_{pK(\text{nom})}}$$

$V_{Z(\text{nom})}$  = Nominal Zener Voltage

$P_{pK(\text{nom})}$  = Found from Figure 8 when device type and pulse width are known. For example, from Figure 8 a 1N6267 zener suppressor has a  $P_{pK(\text{nom})}$  of 1.5 kW at a pulse width of 1 ms. As seen from equation 2, zeners with a larger  $P_{pK(\text{nom})}$  capability will have a lower  $R_{Z(\text{nom})}$ .

### ZENER versus MOV TRADEOFFS

The clamping characteristics of Zeners and MOV's are best compared by measuring their voltages under transient conditions. Photos 1 through 9 are the result of an experiment that was done to compare the clamping characteristics of a Zener (Motorola 1N6281, approximately 1.5J capability) with those of an MOV (G.E. V27ZA4, 4J capability); both are 27 V devices.

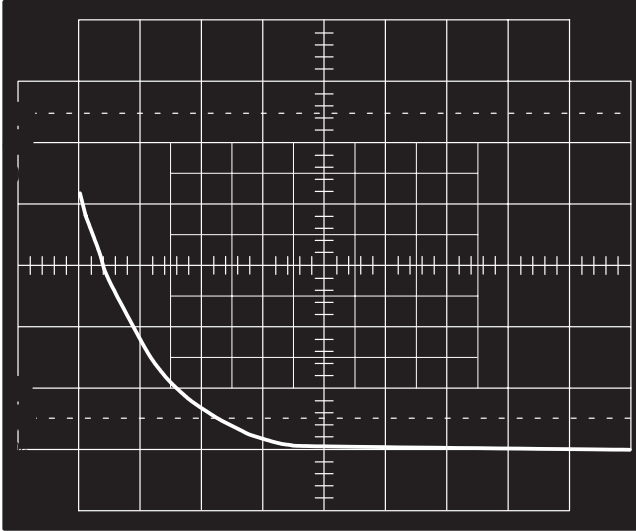
Photo 1 shows the pulse generator output voltage. This generator synthesizes a transient pulse that is characteristic of those that may appear in the real world.

Photos 2 and 3 are clamping voltages of the MOV and Zener, respectively with a surge source impedance of 500 Ω.

Photos 4 and 5 are the clamping voltages with a surge source impedance of 50 Ω.

Photos 6 and 7 simulate a condition where the surge source impedance is 5 Ω.

Photos 8 and 9 show a surge source impedance of 0.55 Ω, which is at the limits of the Zener suppressor's capability.



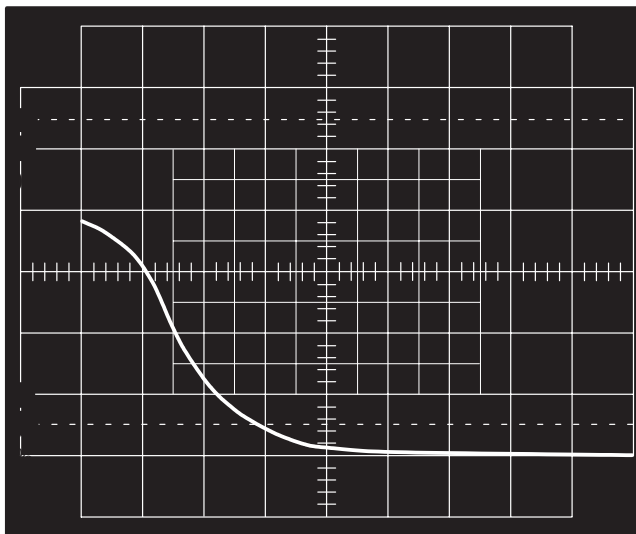
**PHOTO 1**

Open Circuit Transient Pulse

Vert: 20 V/div

Horiz: 0.5 ms/div

$V_{peak} = 90\text{ V}$



**PHOTO 2**

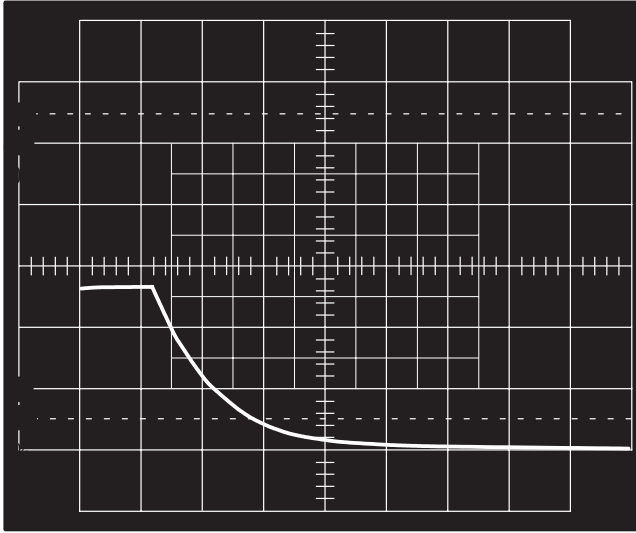
MOV (27 V)

Vert: 10 V/div

Horiz: 0.5 ms/div

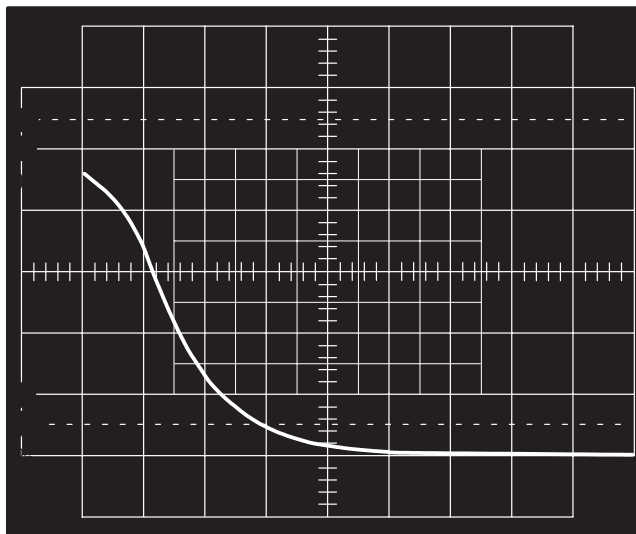
Transient Source Impedance:  $500\ \Omega$

$V_{peak} = 39.9\text{ V}$



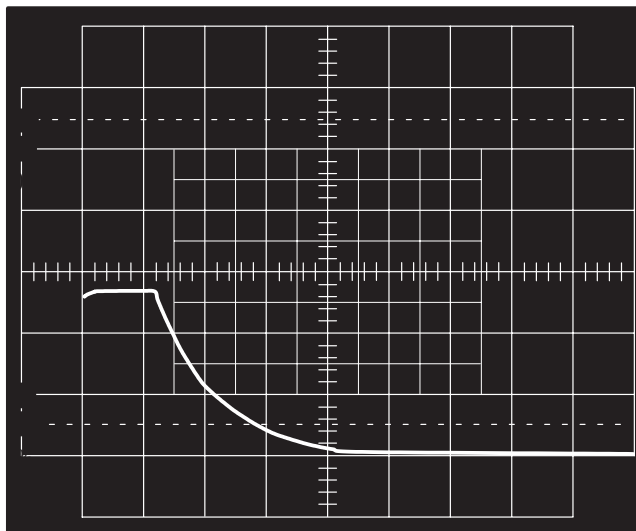
**PHOTO 3**

Zener (27 V)  
 Vert: 10 V/div  
 Horiz: 0.5 ms/div  
 Transient Source Impedance: 500 Ω  
 $V_{peak} = 27 \text{ V}$



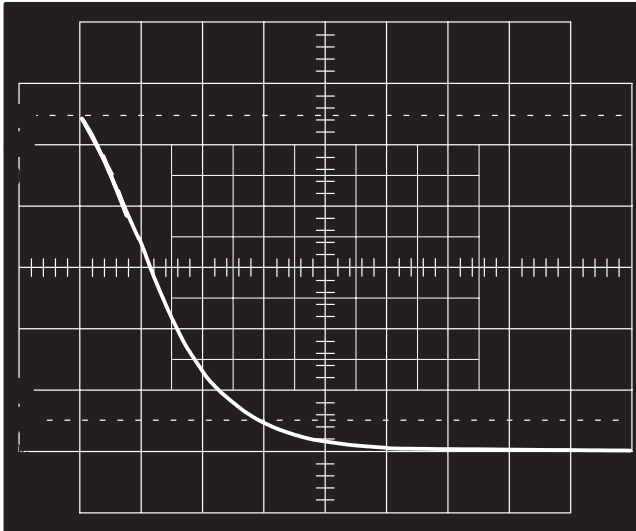
**PHOTO 4**

MOV (27 V)  
 Vert: 10 V/div  
 Horiz: 0.5 ms/div  
 Transient Source Impedance: 50 Ω  
 $V_{peak} = 44.7 \text{ V}$

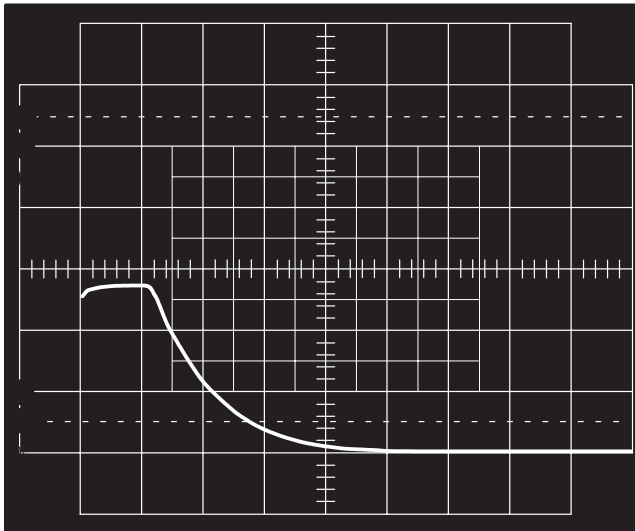


**PHOTO 5**

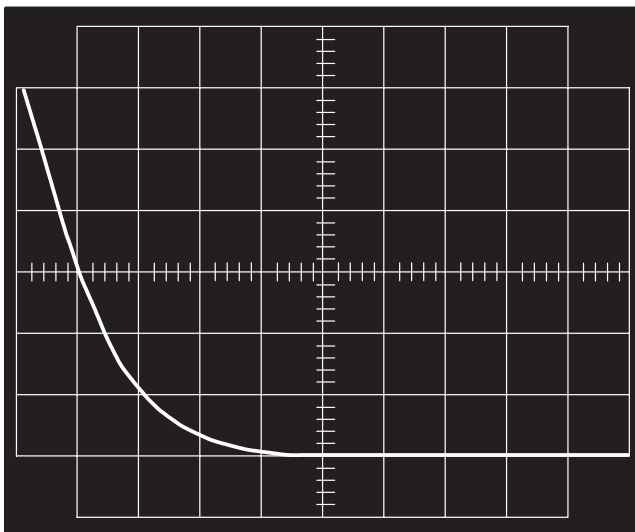
Zener (27 V)  
 Vert: 10 V/div  
 Horiz: 0.5 ms/div  
 Transient Source Impedance: 50 Ω  
 $V_{peak} = 27 \text{ V}$



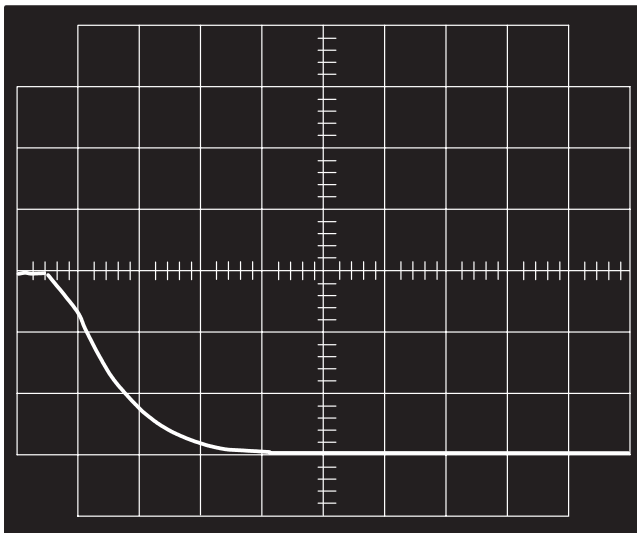
**PHOTO 6**  
 MOV (27 V)  
 Vert: 10 V/div  
 Horiz: 0.5 ms/div  
 Transient Source Impedance: 5  $\Omega$   
 $V_{\text{peak}} = 52 \text{ V}$



**PHOTO 7**  
 Zener (27 V)  
 Vert: 10 V/div  
 Horiz: 0.5 ms/div  
 Transient Source Impedance: 5  $\Omega$   
 $V_{\text{peak}} = 28 \text{ V}$



**PHOTO 8**  
 MOV (27 V)  
 Vert: 10 V/div  
 Horiz: 0.5 ms/div  
 Transient Source Impedance: 0.55  $\Omega$   
 $V_{\text{peak}} = 62.5 \text{ V}$



**PHOTO 9**  
 Zener (27 V)  
 Vert: 10 V/div  
 Horiz: 0.5 ms/div  
 Transient Source Impedance: 0.55 Ω  
 $V_{peak}$ : 30.2 V  
 Peak Power: Approx 2000 W<sub>peak</sub>  
 (The limit of this device's capability)

As can be seen by the photographs, the Zener suppressor has significantly better voltage clamping characteristics than the MOV even though that particular Zener has less than one-fourth the energy capability of the MOV it was compared with. However, the energy rating can be misleading because it is based on the clamp voltage times the surge current, and when using an MOV, the high impedance results in a fairly high clamp voltage. The major tradeoff with using a zener type suppressor is its cost versus power handling capability, but since it would take an “oversized” MOV to clamp voltages (suppress transients) as well as the zener, the MOV begins to lose its cost advantage.

If a transient should come along that exceeds the capabilities of the particular Zener, or MOV, suppressor that was chosen, the load will still be protected, since they both fail short.

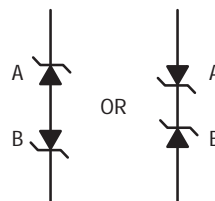
The theoretical reaction time for Zeners is in the picosecond range, but this is slowed down somewhat with lead and package inductance. The 1N6267 Mosorb series of transient suppressors have a typical response time of less than one nanosecond. For very fast rising transients it is important to minimize external inductances (due to wiring, etc.) which will minimize overshoot.

Connecting Zeners in a back-to-back arrangement will enable bidirectional voltage clamping characteristics. (See Figure 10.)

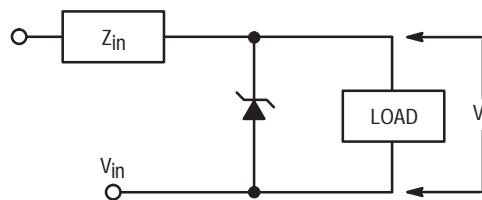
If Zeners A and B are the same voltage, a transient of either polarity will be clamped at approximately that voltage since one Zener will be in reverse bias mode while the other will be in the forward bias mode. When clamping low voltage it may be necessary to consider the forward drop of the forward biased Zener.

The typical protection circuit is shown in Figure 11a. In almost every application, the transient suppression device is placed in parallel with the load, or component to be protected. Since the main purpose of the circuit is to clamp the voltage appearing across the load, the suppressor should

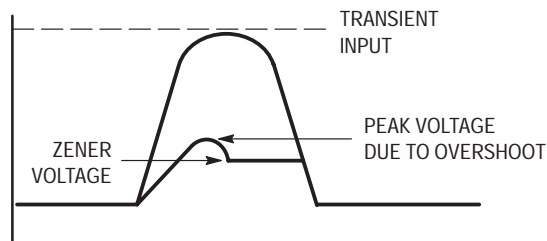
be placed as close to the load as possible to minimize overshoot due to wiring (or any inductive) effect. (See Figure 11b.)



**Figure 10. Zener Arrangement for Bidirectional Clamping**



**Figure 11a. Using Zener to Protect Load Against Transients**



**Figure 11b. Overshoot Due to Inductive Effect**

Zener capacitance prior to breakdown is quite small (for example, the 1N6281 27 Volt Mosorb has a typical capacitance of 800 pF). Capacitance this small is desirable in the off-state since it will not attenuate wide-band signals.

When the Zener is in the breakdown mode of operation (e.g. when suppressing a transient) its effective capacitance increases drastically from what it was in the off-state. This makes the Zener ideal for parallel protection schemes since, during transient suppression, its large effective capacitance will tend to hold the voltage across the protected element constant; while in the off-state (normal conditions, no transient present), its low off-state capacitance will not attenuate high frequency signals.

Input impedance ( $Z_{in}$ ) always exists due to wiring and transient source impedance, but  $Z_{in}$  should be increased as much as possible with an external resistor, if circuit constraints allow. This will minimize Zener stress.

### **CONCLUSION**

The reliable use of semiconductor devices requires that the circuit designer consider the possibility of transient overvoltages destroying these transient-sensitive components.

These transients may be generated by normal circuit operations such as inductive switching circuits, energizing and deenergizing transformer primaries, etc. They do not present much of a problem since their energy content, duration and effect may easily be obtained and dealt with.

Random transients found on power lines, or lightning transients, present a greater threat to electronic components since there is no way to be sure when or how severe they will be. General guidelines were discussed to aid the circuit designer in deciding what size (capability and cost) suppressor to choose for a certain level of protection. There will always be a tradeoff between suppressor price and protection obtained.

Several different suppression devices were discussed with emphasis on Zeners and MOV's, since these are the most popular devices to use in most applications.

### **REFERENCES**

1. GE Transient Voltage Suppression Manual, 2nd edition.
2. Motorola Zener Diode Manual.



# DESIGN CONSIDERATIONS AND PERFORMANCE OF MOTOROLA TEMPERATURE-COMPENSATED ZENER (REFERENCE) DIODES

Prepared by  
Zener Diode Engineering  
and  
Ronald N. Racino  
Reliability and Quality Assurance

## INTRODUCTION

This application note defines Motorola temperature-compensated zener (reference) diodes, explains the device characteristics, describes electrical testing, and discusses the advanced concepts of device reliability and quality assurance. It is a valuable aid to those who contemplate designing circuits requiring the use of these devices.

Zener diodes fall into three general classifications: Regulator diodes, reference diodes and transient voltage suppressors. Regulator diodes are normally employed in power supplies where a nearly constant dc output voltage is required despite relatively large changes in input voltage or load resistance. Such devices are available with a wide range of voltage and power ratings, making them suitable for a wide variety of electronic equipments.

Regulator diodes, however, have one limitation: They are temperature-sensitive. Therefore, in applications in which the output voltage must remain within narrow limits during input-voltage, load-current, and temperature changes, a temperature-compensated regulator diode, called a reference diode, is required.

The reference diode is made possible by taking advantage of the differing thermal characteristics of forward- and reverse-biased silicon p-n junctions. A forward-biased junction has a negative temperature coefficient of approximately 2 mV/°C, while reverse-biased junctions have positive temperature coefficients ranging from about 2 mV/°C at 5.5 V to 6 mV/°C at 10 V. Therefore it is possible, by judicious combination of forward- and reverse-biased junctions, to fabricate a device with a very low overall temperature coefficient (Figure 1).

The principle of temperature compensation is further illustrated in Figure 2, which shows the voltage-current characteristics at two temperature points (25 and 100°C) for both a forward- and a reverse-biased junction. The diagram shows that, at the specified test current ( $I_{ZT}$ ), the absolute value of voltage change ( $\Delta V$ ) for the temperature change between 25 and 100°C is the same for both junctions. Therefore, the total voltage across the combination of these two junctions is also the same at these temperature points, since one  $\Delta V$  is negative and the other is positive. However, the rate of voltage change with temperature over the

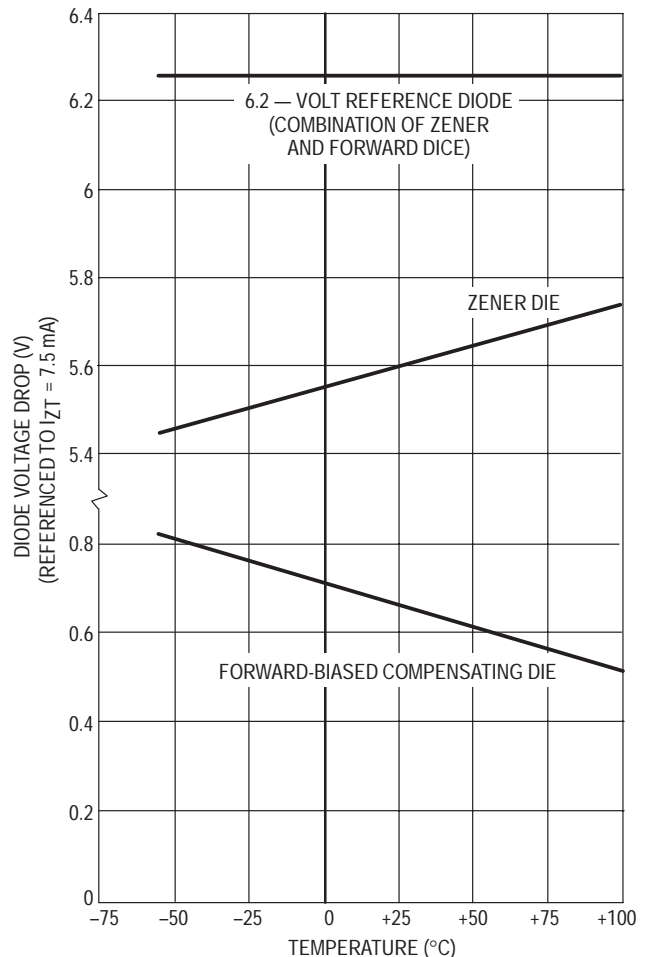


Figure 1. Temperature Compensation of a 6.2 Volt Reference Diode (1N821 Series)

temperature range defined by these points is not necessarily the same for both junctions, thus the temperature compensation may not be linear over the entire range.

Figure 2 also indicates that the voltage changes of the two junctions are equal and opposite only at the specified test current. For any other value of current, the temperature compensation may not be complete.

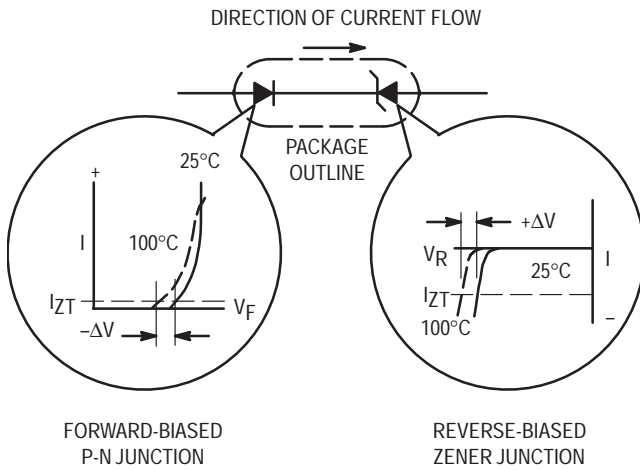


Figure 2. Temperature Compensation of P-N Junctions

**IMPORTANT ELECTRICAL CHARACTERISTICS OF REFERENCE DIODES**

The three most important characteristics of reference diodes are 1) reference voltage, 2) voltage-temperature stability, and 3) voltage-time stability.

**1. Reference Voltage.** This characteristic is defined as the voltage drop measured across the diode when the specified test current passes through it in the zener direction. It is also called the zener voltage ( $V_Z$ , Figure 3). On the data sheets, the reference voltage is given as a nominal voltage for each family of reference diodes.

The nominal voltages are normally specified to a tolerance of  $\pm 5\%$ , but devices with tighter tolerances, such as  $\pm 2\%$  and  $\pm 1\%$ , are available on special order.

**2. Voltage-Temperature Stability.** The temperature stability of zener voltage is sometimes expressed by means

of the temperature coefficient. This parameter is usually defined as the percent voltage change across the device per degree centigrade. This method of indicating voltage stability accurately reflects the voltage deviation at the test temperature extremes but not necessarily at other points within the specified temperature range. This fact is due to variations in the rate of voltage change with temperature for the forward- and reverse-biased dice of the reference diode. Therefore, the temperature coefficient is given in Motorola data sheets only as a quick reference, for designers who are accustomed to this method of specification.

A more meaningful way of defining temperature stability is the "box method." This method, used by Motorola, guarantees that the zener voltage will not vary by more than a specified amount over a specified temperature range at the indicated test current, as verified by tests at several temperatures within this range.

Some devices are accurately compensated over a wide temperature range ( $-55^\circ\text{C}$  to  $100^\circ\text{C}$ ), others over a narrower range (0 to  $75^\circ\text{C}$ ). The wide-range devices are, as a rule, more expensive. Therefore, it would be economically wasteful for the designer to specify devices with a temperature range much wider than actually required for the specific device application.

During actual production of reference diodes, it is difficult to predict the compensation accuracy. In the interest of maximum economy, it is common practice to test all devices coming off the production line, and to divide the production lot into groups, each with a specified maximum  $\Delta V_Z$ . Each group, then, is given a different device type number.

On the data sheet, the voltage-temperature characteristics of the most widely used device types are illustrated in a graph similar to the one shown in Figure 4. The particular production line represented in this figure produces 6.2 volt devices, but the line yields five different device type numbers

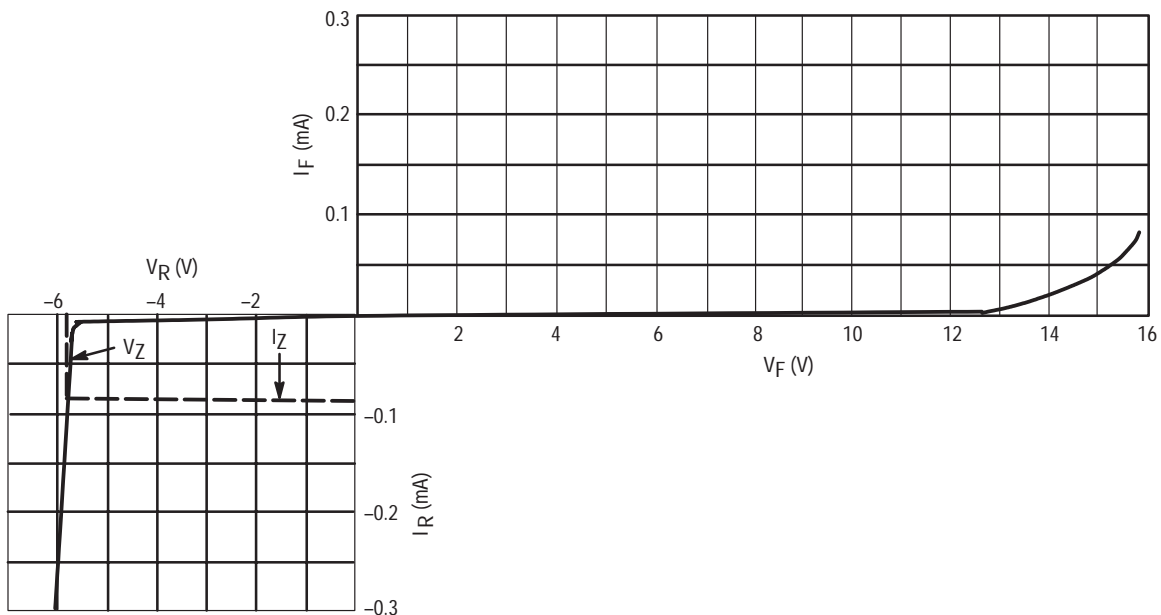
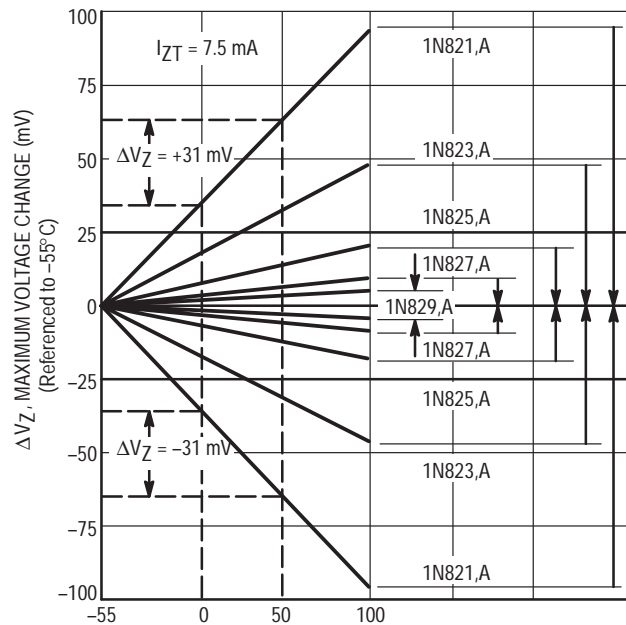


Figure 3. Typical Voltage — Current Characteristic of Reference Diodes

(1N821 through 1N829), each with a different temperature coefficient. The 1N829, for example, has a maximum voltage change of less than 5 mV over a temperature range of  $-55$  to  $+100^{\circ}\text{C}$ , while the 1N821 may have a voltage change of up to 96 mV over the same temperature range.



In the past, design data and characteristic curves on data sheets for reference diodes have been somewhat limited: The devices have been characterized principally at the recommended operating point. Motorola has introduced a data sheet, providing device data previously not available, and showing limit curves that permit worst-case circuit design without the need for associated tests required in conjunction with the conventional data sheets.

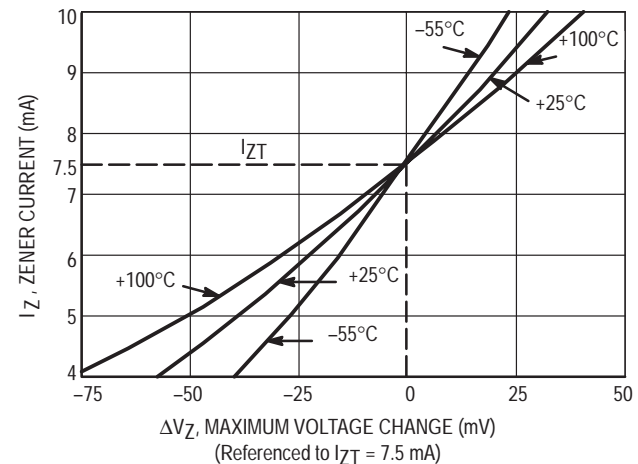
**Figure 4. Temperature Dependence of Zener Voltage (1N821 Series)**

Graphs such as these permit the selection of the lowest-cost device that meets a particular requirement. They also permit the designer to determine the maximum voltage change of a particular reference diode for a relatively small change in temperature. This is done by drawing vertical lines from the desired temperature points at the abscissa of the graph to intersect with each the positive- and negative-going curves of the particular device of interest. Horizontal lines are then drawn from these intersects to the ordinate of the graph. The difference between the intersections of these horizontal lines with the ordinate yields the maximum voltage change over the temperature increment. For example, for the 1N821, a change in ambient temperature from 0 to  $50^{\circ}\text{C}$  results in a voltage change of no more than about  $\pm 31$  mV.

The reason that the device reference voltage may change in either the negative or positive direction is that after assembly, some of the devices within a lot may be overcompensated while others may be undercompensated. In any design, the "worst-case" condition must be considered. Therefore, in the above example, it can be assumed that the maximum voltage change will not exceed 31 mV.

It should be understood, however, that the above calculations give the maximum possible voltage change for the device type, and by no means the actual voltage change for the individual unit.

**3. Voltage-Time Stability.** The voltage-time stability of a reference diode is defined by the voltage change during operating time at the standard test current ( $I_{ZT}$ ) and test temperature ( $T_A$ ). In general, the voltage stability of a reference diode is better than 100 ppm per 1000 hours of operation.



**Figure 5. Current Dependence of Zener Voltage at Various Temperatures (1N821 Series)**

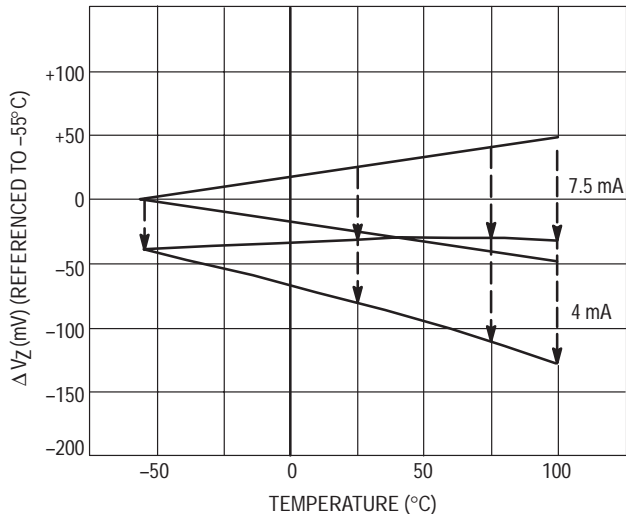
### THE EFFECT OF CURRENT VARIATION ON ZENER VOLTAGE

The nominal zener voltage of a reference diode is specified at a particular value of current, called the zener test current ( $I_{ZT}$ ). All measurements of voltage change with temperature are referenced to this test current. If the operating current is varied, all these specifications will change.

The effect of current variation on zener voltage, at various temperatures, is graphically illustrated on the 1N821 data sheet as "Zener Current versus Maximum Voltage Change." A typical example of such a graph is shown for the 1N821 series in Figure 5. The voltage change shown is due entirely to the impedance of the device at the fixed temperature. It does not reflect the change in reference voltage due to the change in temperature since each curve is referenced to  $I_{ZT} = 7.5$  mA at the indicated temperature. As shown, the greatest voltage change occurs at the highest temperature represented in the diagram. (See "Dynamic Impedance" under the next section).

Figure 5 shows that, at  $25^{\circ}\text{C}$ , a change in zener current from 4 to 10 mA causes a voltage shift of about 90 mV. Comparing this value with the voltage-change example in Figure 4 (31 mV), it is apparent that, in general, a greater voltage variation may be due to current fluctuations than to temperature change. Therefore, good current regulation of the source should be a major consideration when using reference diodes in critical applications.

It is not essential, however, that a reference diode be operated at the specified test current. The new voltage-temperature characteristics for a change in current can be obtained by superimposing the data of Figure 5 on that of Figure 4. A new set of characteristics, at a test current of 4 mA, is shown for the 1N823 in Figure 6, together with the original characteristics at 7.5 mA.



**Figure 6. Voltage Change with Temperature for 1N823 at Two Different Current Levels**

From these characteristics, it is evident that the voltage change with temperature for the new curves is different from that for the original ones. It is also apparent that if the test current varies between 7.5 and 4 mA, the voltage changes would lie along the dashed lines belonging to the given temperature points. This clearly shows the need for a well-regulated current source.

It should be noted, however, that even when a well-regulated current supply is available, other factors might influence the current flowing through a reference diode. For example, to minimize the effects of temperature-sensitive passive elements in the load circuit on current regulation, it is desirable that the load in parallel with the reference diode have an impedance much higher than the dynamic impedance of the reference diode.

**OTHER CHARACTERISTICS**

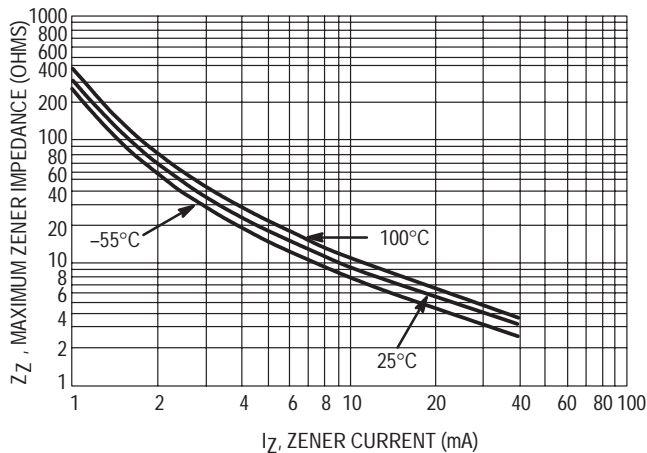
In addition to the three major characteristics discussed earlier, the following parameters and ratings of reference diodes may be considered in some applications.

**Power Dissipation**

The maximum dc power dissipation indicates the power level which, if exceeded, may result in the destruction of the device. Normally a device will be operated near the specified test current for which the data-sheet specifications are applicable. This test current is usually much below the current level associated with the maximum power dissipation.

**Dynamic Impedance**

Zener impedance may be construed as composed of a current-dependent resistance shunted by a voltage-dependent capacitance. Figure 7 indicates the typical variations of dynamic zener impedance ( $Z_Z$ ) with current and temperature for the 1N821 reference diode series. These diagrams are given in the 1N821 data sheet. As shown, the zener impedance decreases with current but increases with ambient temperature.



**Figure 7. Variation of Zener Impedance With Current and Temperature (1N821 Series)**

The impedance of a reference diode is normally specified at the test current ( $I_{ZT}$ ). It is determined by measuring the ac voltage drop across the device when a 60 Hz ac current with an rms value equal to 10% of the dc zener current is superimposed on the zener current ( $I_{ZT}$ ). Figure 8 shows the block diagram of a circuit used for testing zener impedance.

**ELECTRICAL TESTING**

All devices are tested electrically as a last step in the manufacturing process.

The subsequent final test procedures represent an automated and accurate method of electrically classifying reference diodes. First, an electrical test is performed on all devices to insure the correct voltage-breakdown and stability characteristics. Next, the breakdown voltage and dynamic impedance are measured. Finally, the devices are placed in an automatic data acquisition system that automatically cycles them through the complete temperature range specified. The actual voltage measurements at the various temperature points are retained in the system computer memory until completion of the full temperature excursion. The computer then calculates the changes in voltage for each device at each test temperature and classifies all units on test into the proper category. The system provides a printed readout for every device, including the voltage changes to five digits during temperature cycling, and the corresponding EIA type number, as well as the data referring to test conditions such as device position, lot number, and date.

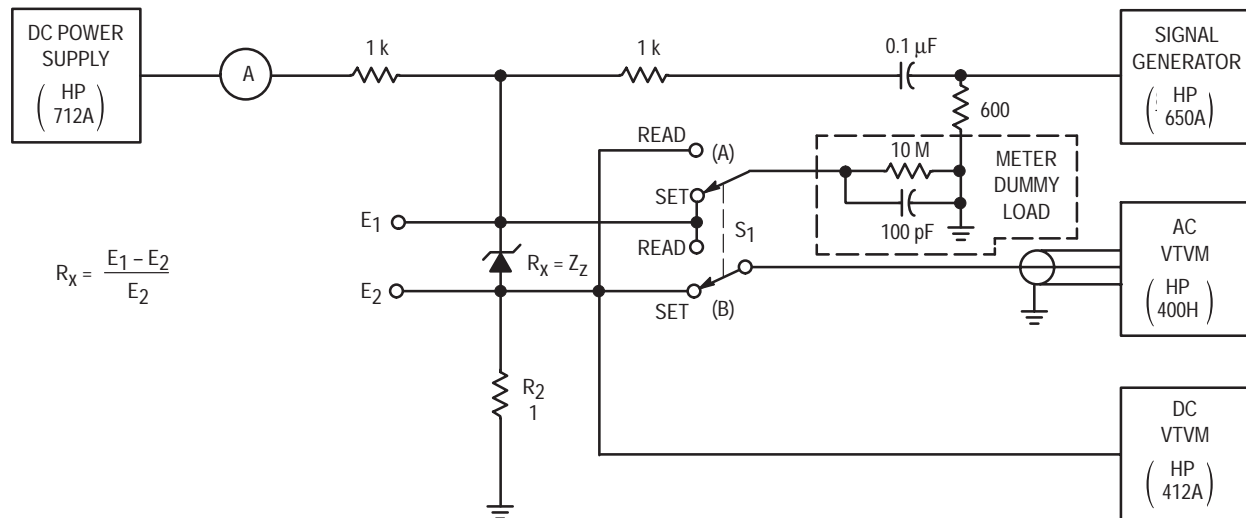


Figure 8. Block Diagram of Test Circuit for Measuring Dynamic Zener Impedance

### DEVICE RELIABILITY AND QUALITY ASSURANCE

Insuring a very low failure rate requires maximum performance in all areas effecting device reliability: Device design, manufacturing processes, quality control, and reliability testing. Motorola's basic reliability concept is based on the belief that reference diode reliability is a complex yet controllable function of all these variables.

Under this "total reliability" concept, Motorola can mass-produce high-reliability reference diodes.

The reliability of a reference diode fundamentally depends upon the device design, regardless of the degree of effort put into device screening and circuit designing. Therefore, reliability measures must be incorporated at the device design and process development stages to establish a firm foundation for a comprehensive reliability program. The design is then evaluated by thorough reliability testing, and the results are supplied to the Design Engineering department. This closed-loop feedback procedure provides valuable information necessary to improve important design features such as electrical instability due to surface effects, mechanical strength, and uniformly low thermal resistance between the die and ambient environment.

#### Process Control

There are more than 2000 variables that must be kept under control to fabricate a reliable reference diode. The

in-process quality control group controls most of these variables. It places a strict controls on all aspects of manufacturing from materials procurement to the finished product. Included in this broad spectrum of controls are:

- **Materials Control.** All materials purchased or fabricated in-plant are checked against rigid specifications. A quality check on vendors' products is kept up to date to insure that only materials of a proven quality level will be purchased.
- **In-Process Inspection and Control.** Numerous on-line inspection stations maintain a statistical process control program on specific manufacturing processes. If any of these processes are found to be out of control, the discrepant material is diverted from the normal production flow and the cognizant design engineer notified. Corrective action is initiated to remedy the cause of the discrepancy.

#### Reliability Testing

The Reliability Engineering group evaluates all new products and gives final conclusions and recommendations to the device design engineer. The Reliability Engineering group also performs independent testing of all products and includes, as part of this testing program, step-stress-to-failure testing to determine the maximum capabilities of the product.

# SOME STRAIGHT TALK ABOUT MOSORBBS TRANSIENT VOLTAGE SUPPRESSORS

## INTRODUCTION

Distinction is sometimes made between devices trademarked Mosorb (by Motorola Inc.), and standard zener/avalanche diodes used for reference, low-level regulation and low-level protection purposes. It must be emphasized from the beginning that Mosorb devices are, in fact, zener diodes. The basic semiconductor technology and processing are identical. The primary difference is in the applications for which they are designed. Mosorb devices are intended specifically for transient protection purposes and are designed, therefore, with a large effective junction area that provides high pulse power capability while minimizing the total silicon use. Thus, Mosorb pulse power ratings begin at 500 watts — well in excess of low power conventional zener diodes which in many cases do not even include pulse power ratings among their specifications.

MOVs, like Mosorbs, do have the pulse power capabilities for transient suppression. They are metal oxide varistors (not semiconductors) that exhibit bidirectional avalanche characteristics, similar to those of back-to-back connected zeners. The main attributes of such devices are low manufacturing cost, the ability to absorb high energy surges (up to 600 joules) and symmetrical bidirectional “breakdown” characteristics. Major disadvantages are: high clamping factor, an internal wear-out mechanism and an absence of low-end voltage capability. These limitations restrict the use of MOVs primarily to the protection of insensitive electronic components against high energy transients in application above 20 volts, whereas, Mosorbs are best suited for precise protection of sensitive equipment even in the low voltage range — the same range covered by conventional zener diodes. The relative features of the two device types are covered in Table 1.

## IMPORTANT SPECIFICATIONS FOR MOSORB PROTECTIVE DEVICES

Typically, a Mosorb suppressor is used in parallel with the components or circuits being protected (Figure 1), in order to shunt the destructive energy spike, or surge, around the more sensitive components. It does this by avalanching at its “breakdown” level, ideally representing an infinite impedance at voltages below its rated breakdown voltage, and essentially zero impedance at voltages above this level.

In the more practical case, there are three voltage specifications of significance, as shown in Figure 1a.

- a)  $V_{RWM}$  is the maximum reverse stand-off voltage at which the Mosorb is cut off and its impedance is at its highest value — that is, the current through the device is essentially the leakage current of a back-biased diode.
- b)  $V_{(BR)}$  is the breakdown voltage — a voltage at which the device is entering the avalanche region, as indicated by a slight (specified) rise in current beyond the leakage current.
- c)  $V_{RSM}$  is the maximum reverse voltage (clamping voltage) which is defined and specified in conjunction with the maximum reverse surge current so as not to exceed the maximum peak power rating at a pulse width (tp) of 1 ms (industry std time for measuring surge capability).

## RELATIVE FEATURES OF MOVs and MOSORBBS

Table 1.	
MOV	Mosorb/Zener Transient Suppressor
<ul style="list-style-type: none"> <li>• High clamping factor.</li> <li>• Symmetrically bidirectional.</li> <li>• Energy capability per dollar usually higher than a silicon device. However, if good clamping is required the energy capability would have to be grossly overspecified resulting in higher cost.</li> <li>• Inherent wear out mechanism clamp voltage degrades after every pulse, even when pulsed below rated value.</li> <li>• Ideally suited for crude ac line protection.</li> <li>• High single-pulse current capability.</li> <li>• Degrades with overstress.</li> <li>• Good high voltage capability.</li> <li>• Limited low voltage capability.</li> </ul>	<ul style="list-style-type: none"> <li>• Very good clamping close to the operating voltage.</li> <li>• Standard parts perform like standard zeners. Symmetrical bidirectional devices available for many voltages.</li> <li>• Good clamping characteristic could reduce overall system cost.</li> <li>• No inherent wear out mechanism.</li> <li>• Ideally suited for precise DC protection.</li> <li>• Medium multiple-pulse current capability.</li> <li>• Fails short with overstress.</li> <li>• Limited high voltage capability unless series devices are used.</li> <li>• Good low voltage capability.</li> </ul>

In practice, the Mosorb is selected so that its  $V_{RWM}$  is equal to or somewhat higher than the highest operating voltage required by the load (the circuits or components to be protected). Under normal conditions, the Mosorb is inoperative and dissipates very little power. When a transient occurs, the Mosorb converts to a very low dynamic impedance and the voltage across the Mosorb becomes the clamping voltage at some level above  $V_{(BR)}$ . The actual clamping level will depend on the surge current through the Mosorb. The maximum reverse surge current ( $I_{RSM}$ ) is specified on the Mosorb data sheets at 1 ms and for a logarithmically decaying pulse waveform. The data sheet also contains curves to determine the maximum surge current rating at other time intervals.

Typically, Mosorb devices have a built-in safety margin at the maximum rated surge current because the clamp voltage,  $V_{RSM}$ , is itself, guardbanded. Thus, the parts will be operating below their maximum pulse-power ( $P_{pk}$ ) rating even when operated at maximum reverse surge current).

If the transients are random in nature (and in many cases they are), determining the surge-current level can be a problem. The circuit designer must make a reasonable estimate of the proper device to be used, based on his knowledge of the system and the possible transients to be encountered. (e.g., transient voltage, source impedance and time, or transient energy and time are some characteristics that must be estimated). Because of the very low dynamic impedance of Mosorb devices in the region between  $V_{(BR)}$  and  $V_{RSM}$ , the maximum surge current is dependent on, and limited by the external circuitry.

In cases where this surge current is relatively low, a conventional zener diode could be used in place of a Mosorb or other dedicated protective device with some possible savings in cost. The surge capabilities most of Motorola's zener diode lines are discussed in Motorola's Application Note AN784.

In the data sheets of some protective devices, the parameter for response time is emphasized. Response time on these data sheets is defined as the time required for the voltage across the protective device to rise from 0 to  $V_{(BR)}$ , and relates primarily to the effective series impedance associated with the device. This effective impedance is somewhat complex and changes drastically from the blocking mode to the avalanche mode. In most applications (where the protective device shunts the load) this response time parameter becomes virtually meaningless as indicated by the waveforms in Figures 1b and 1c. If the response time as defined is very long, it still would not affect the performance of the surge suppressor.

However, if the series inductance becomes appreciable, it could result in "overshoot" as shown in Figure 1d that would be detrimental to circuit protection. In Mosorb devices, series inductance is negligible compared to the inductive effects of the external circuitry (primarily lead lengths). Hence, Mosorbs contribute little or nothing to overshoot and, in essence, the parameter of response time has very little significance. However, care must be exercised in the design of the external circuitry to minimize overshoot.

## SUMMARY

In selecting a protective device, it is important to know as much as possible about the transient conditions to be encountered. The most important device parameters are reverse working voltage ( $V_{RWM}$ ), surge current ( $I_{RSM}$ ), and clamp voltage ( $V_{RSM}$ ). the product of  $V_{RSM}$  and  $I_{RSM}$  yields the peak power dissipation, which is one of the prime categories for device selection.

The selector guide, in this book, gives a broad overview of the Mosorb transient suppressors now available from Motorola. For more detailed information, please contact your Motorola sales representative or distributor.

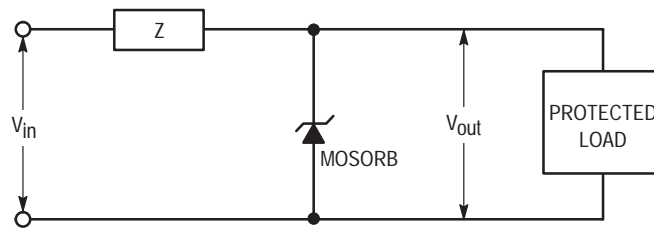


Figure 1.

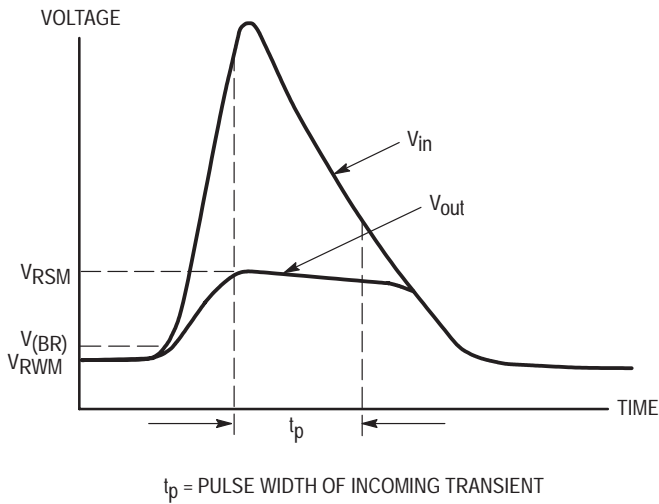


Figure 1a.

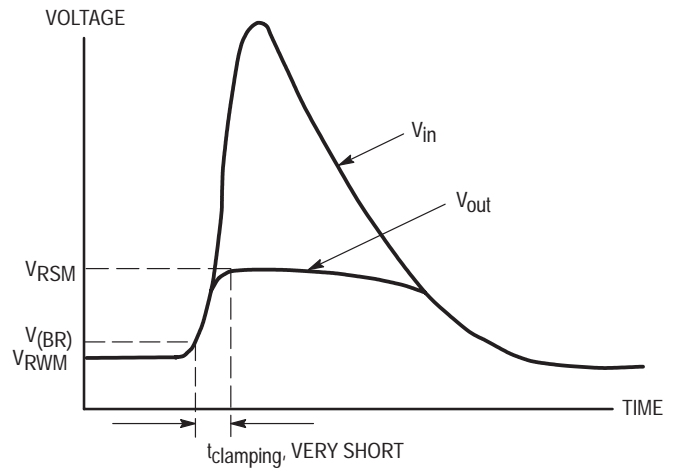


Figure 1b.

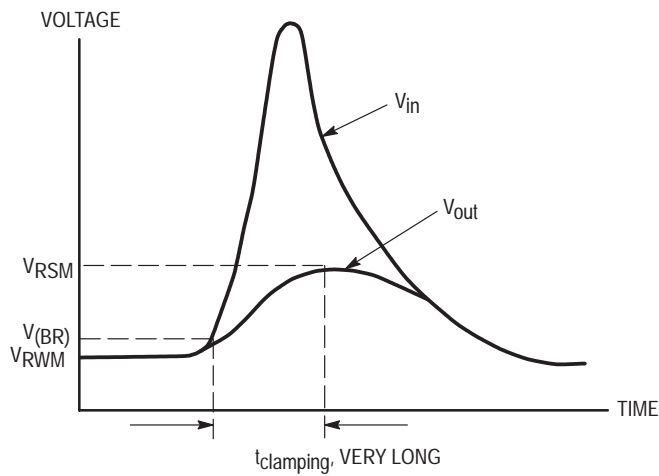


Figure 1c.

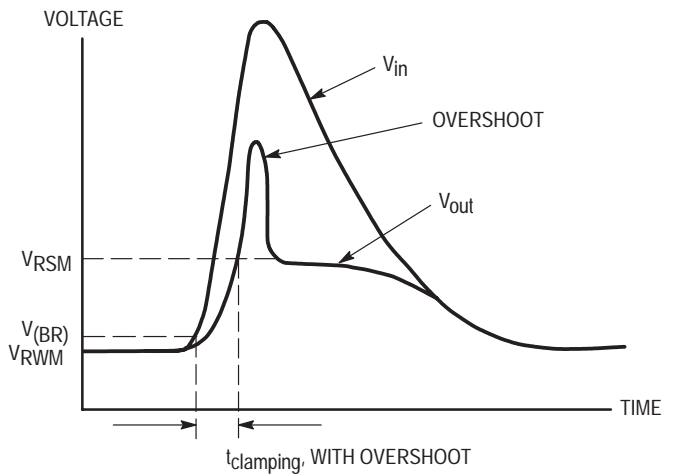
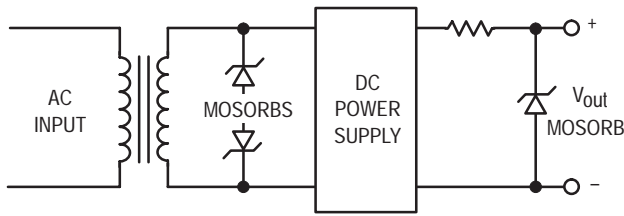


Figure 1d.

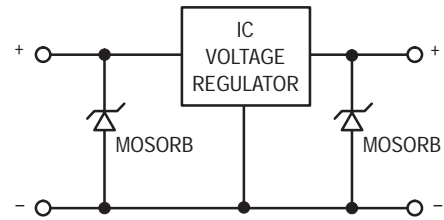


TYPICAL MOSORB APPLICATIONS

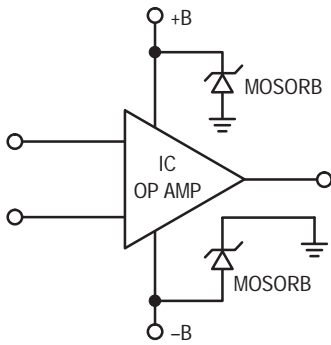
DC Power Supplies



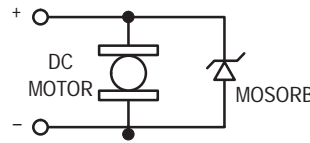
Input/Output Regulator Protection



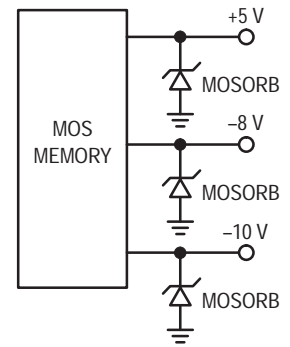
Op Amp Protection



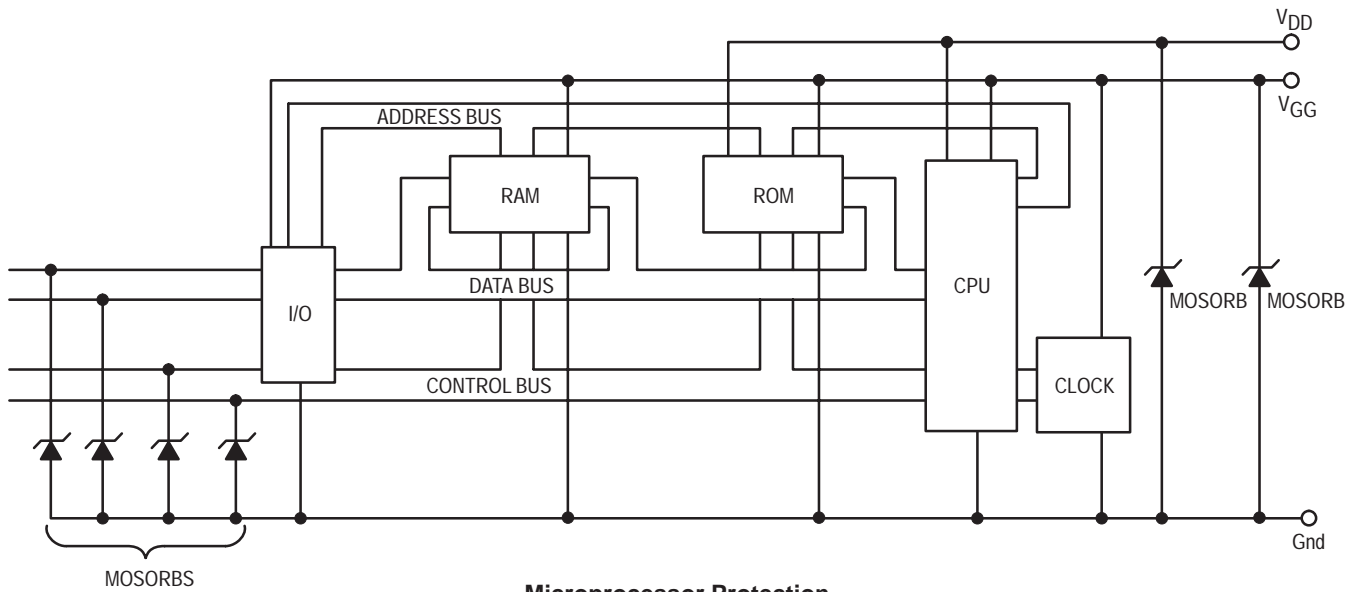
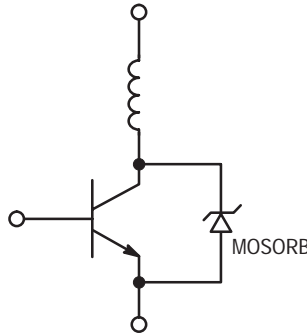
DC Motors — Reduces EMI



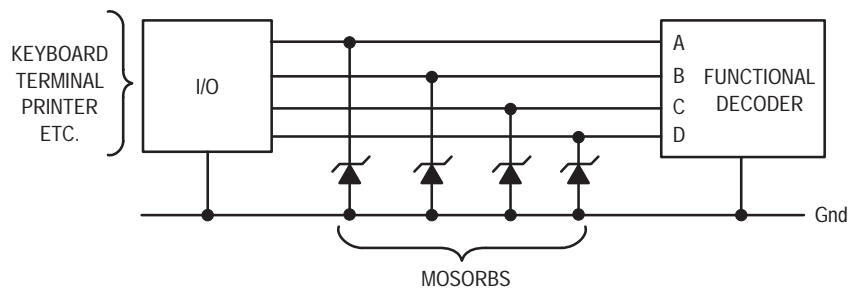
Memory Protection



Inductive Switching Transistor Protection



Microprocessor Protection



Computer Interface Protection

# AR450 — CHARACTERIZING OVERVOLTAGE TRANSIENT SUPPRESSORS

Prepared by  
AI Pshaenich  
Motorola Power Products Division

The use of overvoltage transient suppressors for protecting electronic equipment is prudent and economically justified. For relatively low cost, expensive circuits can be safely protected by one or even several of the transient suppressors on the market today. Dictated by the type and energy of the transient, these suppressors can take on several forms.

For example, in the telecommunication field, where lightning induced transients are a problem, such primary suppressors as gas tubes are often used followed by secondary, lower energy suppressors. In an industrial or automotive environment, where transients are systematically generated by inductive switching, the transient energy is more well-defined and thus adequately suppressed by relatively low energy suppressors. These lower energy suppressors can be zener diodes, rectifiers with defined reverse voltage ratings, metal oxide varistors (MOVs), thyristors, and trigger devices, among others. Each device has its own niche: some offer better clamping factors than others, some have tighter voltage tolerances, some are higher voltage devices, others can sustain more energy and still others, like the thyristor family, have low on-voltages. The designer's problem is selecting the best device for the application.

Thus, the intent of this article is twofold:

1. To describe the operation of the surge current test circuits used in characterizing lower energy transient suppressors.
2. To define the attributes of the various suppressors, allowing the circuit designer to make the cost/performance tradeoffs.

Surge suppressors are generally specified with exponentially decaying and/or rectangular current pulses. The exponential surge more nearly simulates actual surge current conditions — capacitor discharges, line and switching transients, lightning induced transients, etc., whereas rectangular surge currents are usually easier to implement and control.

To generate an exponential rating, a charged capacitor is simply dumped into the device under test (DUT) and the energy of each successive pulse increased until the device ultimately fails. The simplified circuit of Figure 1a describes the circuit. By varying the size of the capacitor C, the limiting resistor R2, and the voltage to which C is charged to, various peak currents and pulse widths (defined to the 10% discharge point in this paper) can be obtained. To automate this circuit, the series switches S1 and S2 can be replaced with appropriately controlled transistors or SCRs.

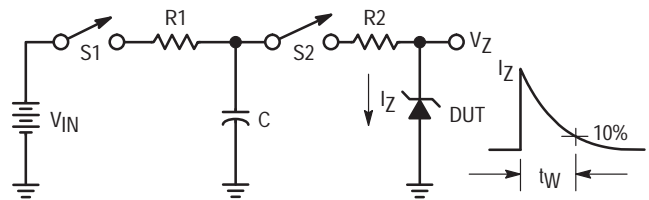


Figure 1a. Simplified Exponential Tester

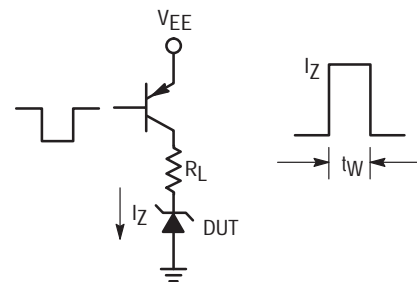


Figure 1b. Simplified Rectangular Tester Using PNP Switch

Figure 1. Basic Surge Current Testers

One method of easily implementing a rectangular surge current pulse is shown in the simplified schematic of Figure 1b. A PNP transistor switch connected to the positive supply  $V_{EE}$  applies power to the DUT. The current is obviously set by varying either  $V_{EE}$  and/or  $R_L$ . If however, the transistor switch were replaced with a variable, constant current source, measurement procedures are simplified as how the limiting resistor need not be selected for various current conditions.

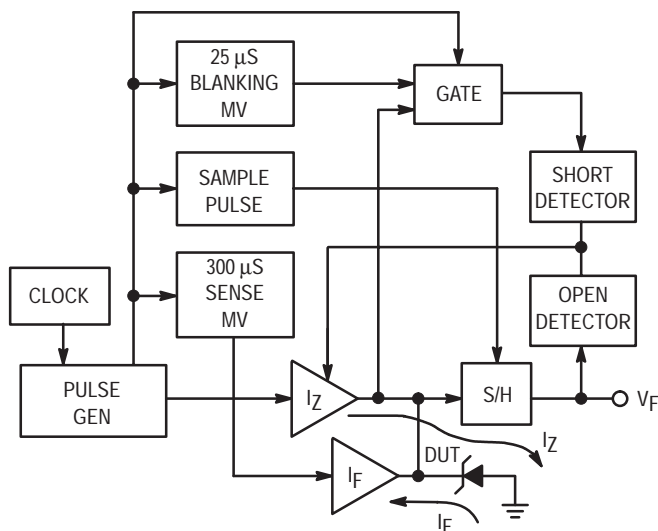
As in most surge current evaluations, the DUT is ultimately subjected to destructive energy (current, voltage, pulse width), the failure points noted, and the derated points plotted to produce the energy limitation curve. Of particular interest is the junction temperature at which the DUTs are operated, be it near failure or at the specified derated point. This measurement relates to the overall reliability of the suppressor, i.e., can the suppressor sustain one surge current pulse or a thousand, and will it be degraded when operated above the specified maximum operating temperature?

The Rectangular Current Surge Suppressor Test Circuit to be described addresses these questions by implementing and measuring the rectangular current capability of the suppressor and determining the device junction temperature

$T_J$  shortly after the end of the surge current pulse. Knowing  $T_J$ , the energy to the DUT can be limited just short of failure and thus a complete surge curve generated with only one, or a few DUTs (Figure 6). Second, with the junction temperature known, a reliability factor can be determined for a practical application.

### CIRCUIT OPERATION FOR THE RECTANGULAR CURRENT TESTER

The Surge Suppressor Test Circuit block diagram is shown in Figure 2 with the main blocks being the Constant Current Amplifier supplying  $I_Z$  to the DUT (a zener diode in this instance) during the power pulse and the Diode Forward Current Switch supplying  $I_F$  during the temperature sensing time. These two pulses are applied sequentially, first the much larger  $I_Z$ , and then the very small sense current  $I_F$ . During the  $I_F$  time, the forward voltage  $V_F$  of the diode is measured from which the junction temperature of the zener diode can be determined. This is simply done by calibrating the forward biased DUT with a specified low value of  $I_F$  in a temperature chamber, one point at 25°C and a second point at some elevated temperature. The result is the familiar diode forward voltage versus temperature linear plot with a slope of about  $-2$  mV/°C for typical diodes (Figure 7a). Comparing the plot with the test circuit measured  $V_F$  yields the DUT junction temperature for that particular pulse width and  $I_Z$  (Figure 7b).



**Figure 2. Surge Suppressor Test Circuit Block Diagram**

The System Clock, Pulse Generator, the several monostable multivibrators (25  $\mu$ s Blanking, Sample Pulse and 300  $\mu$ s Sense MVs) and Gate are fashioned from three CMOS gate ICs. The remaining blocks are the Sample and

Hold (S/H) circuit and two detectors for determining the status of failed DUTs, either shorted devices or open.

Shown in Figures 3 and 4 respectively, are the complete circuit and significant waveforms. Clocking for the system is derived from a CMOS, two inverters, astable MV (gates 1A and 1B) whose output triggers the two input NOR gate configured monostable MV (gates 1C and 1D) to produce the Pulse Generator output pulse (Figure 4b). Alternatively, a single pulse can be obtained by setting switch S2 to the One Shot position and depressing the pushbutton Start switch S1. Contact bounce is suppressed by the 100 ms MV (gates 4C and D). Frequency of the astable MV, set by potentiometer R1, can vary from about 200 Hz to 0.9 Hz and the pulse width, controlled by R2 and the capacitor timing selector switch S3, from about 300  $\mu$ s to 1.3 s.

The positive going Pulse Generator output feeds the Constant Current Amplifier  $I_Z$  and turns on, in order, NPN transistor Q1, PNP transistor Q3, NPN Darlington Q4, PNP Power Darlington Q6 and parallel connected PNP Power Transistors Q8 and Q9. Transistor Q4 is configured as a constant current source whose current is set by the variable base voltage potentiometer R3. Thus, the voltage to the bases of Q6, Q8 and Q9 are also accordingly varied. Transistors Q8 and Q9 (MJ14003,  $I_C$  continuous of 60 A), also connected as constant current sources with their 0.1  $\Omega$  emitter ballasting resistors, consequently can produce a rectangular current pulse from a minimum of about 0.5 A and still have adequate gain for 1 ms pulses of 150A peak. Due to propagation delays of this amplifier, the  $I_Z$  current waveform is as shown in Figure 4f. Since Q8 and Q9 must be in the linear region for constant current operation, these transistors are power dissipation limited at high currents to the externally connected power supply  $V_+$  of 60 V. Thus the maximum DUT voltage, taking into account the clamping factor of the device, should be limited to about 50 V. At wider pulse widths and consequently lower currents before the DUT fails, the  $V_+$  supply should be proportionally reduced to minimize Q8, Q9 dissipation. As an example, a 28 V surge suppressor operating at 100 ms pulse widths can be tested to destructive limits with  $V_+$  of about 40 V. Although a zener diode is shown as the DUT in the schematic, the test devices can be any rectifier with defined reverse voltage, e.g., surge suppressors.

Immediately after the power pulse is applied to the DUT, the negative going sense pulse from the 300  $\mu$ s MV (Gate 2A, Figure 4e) turns on series connected PNP transistor Q10 and NPN transistor Q11 of the Diode Forward Current Switch  $I_F$ . Sense current, set by current limiting resistor selector switch S4, thus flows up from ground through the forward biased DUT, the limiting resistor, and Q11 to the  $-15$  V supply. The result, by monitoring the cathode of the DUT, is a 300  $\mu$ s wide, approximately  $-0.6$  V pulse.

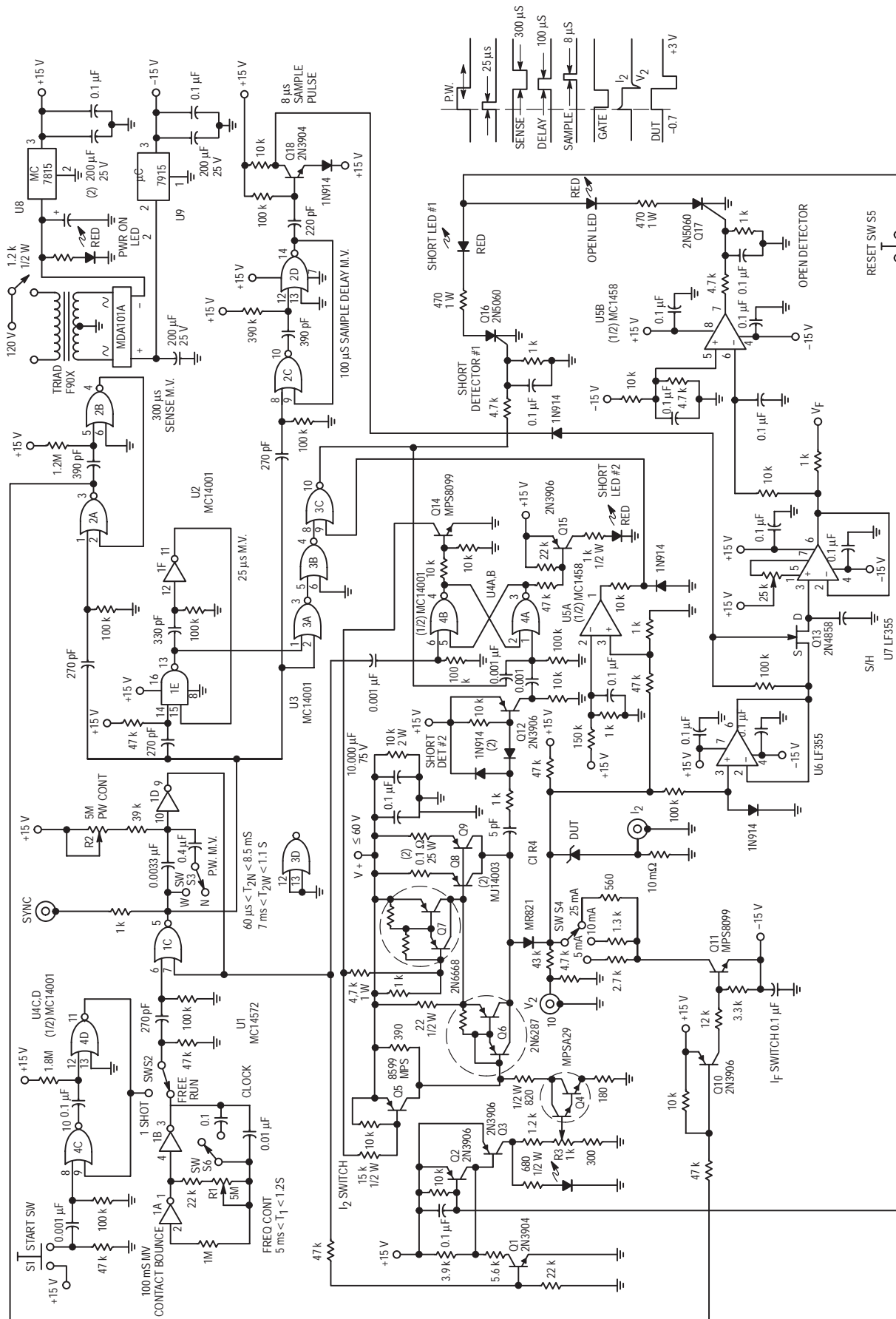


Figure 3. Surge Suppressors Surge Current Fixture

For accurate measurements of this pulse amplitude, sample and hold circuitry is employed. This consists of unity gain buffer amp U6, series FET switch Q13 and capacitor hold buffer amp U7. The sample pulse (Figure 4H) to the gate of the FET is delayed about 100  $\mu$ s (by monostable MV G-2C and G-2D) to allow for switching and thermal transients to settle down. This pulse is derived from the negative going, trailing edge output pulse of Gate 2D cutting off transistor Q18 for the RC time constant in its base circuit. The result is an approximate 8  $\mu$ s wide sample pulse. Consequently, the DC output voltage from hold amplifier U7 is a measure of the DUT junction temperature.

Invariably, most DUTs will fail short. When the surge suppressor tester is in the Free-run Mode, the power pulse subsequent to the DUT shorting could excessively stress the constant current drivers Q8 and Q9. To prevent this occurrence, the Short Detector circuit was implemented. This circuit consists of comparator U5A, 2 input NOR gate configured 25  $\mu$ s monostable MV (G1E and G1F), Gate Circuit G3A, 3B and 3C, and SCR Q16. The 25  $\mu$ s MV

(Figure 4D) is required to blank out turn-on switching transients to produce the waveform shown in Figure 4I. During the power pulse, U5A is normally high for a good DUT (Figure 4J). This waveform is NOR'd with gate 3B (inverted waveform of Figure 4I) to produce a low level (0 V) gate 3C output (Figure 4K).

If, however, the DUT is shorted, U5A output switches low resulting in a positive pulse output from G3C. This pulse triggers the SCR on, lighting the LED in its anode circuit and turning on the PNP transistor Q2 across the emitter-base of Q3, thus clamping off the  $I_z$  power pulse. The circuit (Q16) can be reset by opening switch S5.

By and large, this Short Detector circuit was found adequate to protect transistors Q8 and Q9. However, for some wide pulse widths, relatively high current conditions, the propagation delay through the Short Detector was too great, resulting in excessive FBSOA (Forward Bias Safe Operating Area) stress on Q8 and Q9. Consequently, a faster Short Detector #2 was implemented.

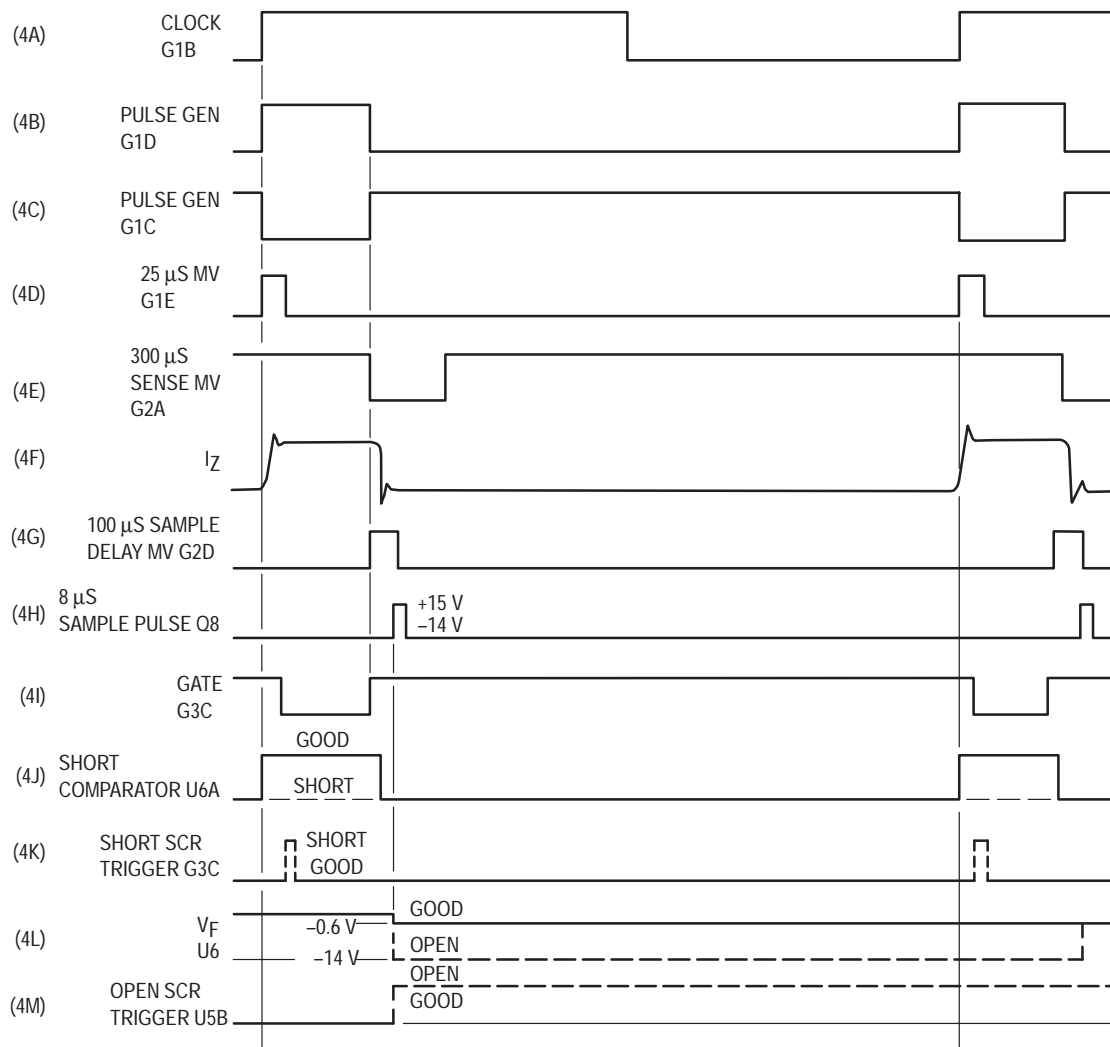


Figure 4. Surge Suppressor Test Circuit Waveforms

This circuit, connected to the collectors of Q8 and Q9, uses a differentiating network (R4, C1) to discriminate between the normally relatively slow fall time of the voltage pulse on the DUT, and the exceedingly fast fall time when the device fails. Thus, the R4-C1 time constant (5 ns) will only generate a negative going trigger to PNP transistor Q12 when the DUT voltage collapses during device failure. The positive going output from Q12 resets the flip-flop (gates 4A and 4B), which turns on the NPN transistor Q14. This transistor supplies drive to the two PNP clamp transistors (Q5 and Q7) placed respectively across the emitter-bases of the high, constant current stages Q6 and Q8 and Q9. Propagation delay is thus minimized, providing greater protection to the power stages of the tester. As an added safety feature, the positive going output from Gate 3C when Short Detector #1 is activated is also used to trigger the flip-flop.

On the few occasions when the DUT fails open, then the Open Detector consisting of comparator U5B and SCR Q17 comes into play. This circuit measures the DUT integrity during the sense time. For a good DUT ( $V_F < -1$  V), U5B output remains low (see Figures 4L and 4M). However for an open DUT,  $V_F$  switches to the negative rail and U5B goes high, turning on Q17. As in the Short Detector, Q2 clamps off the I<sub>Z</sub> power amplifier.

All of the circuitry including the +15 V and -15 V regulated power supplies are self-contained, with the exception of the V+ supply. For high current, narrow pulse width testing, this external supply should have 10 to 15 A capability. If not, additional energy storing capacitors across the supply output may be required.

### CIRCUIT OPERATION FOR THE EXPONENTIAL SURGE CURRENT TESTER

To generate the surge current curve of peak current versus exponential discharge pulse width, the test circuit of Figure 5 was designed. This tester is an implementation of the simplified capacitor discharge circuit shown in Figure 1A, with the PNP high voltage transistor Q2 allowing the capacitor C to charge through limiting resistor R1 and a triggered SCR discharging the capacitor. As shown in Figure 5, the DUTs can be of any technology, although the device connected to the capacitor and discharge limiting resistor R<sub>S</sub> is shown as a MOS SCR. It could just as well have been an SCR as the DUT or as the switch for the zener diode, rectifier, SIDAC, etc., DUTs.

System timing for this Exponential Surge Current Tester is derived from a CMOS quad 2 input NOR gate with gates 1A and 1B comprising a non-symmetrical astable MV of about 13 seconds on and about one second off (switch S3 open). The positive On pulse from gate 1B turns on the 500 V power MOSFET Q1 and the following PNP transistor Q2. The extremely high current gain FET allows for the large base current variation of Q2 with varying supply voltage (V+). This capacitor charging circuit has a 400 V blocking capability (limited by the V<sub>CEO</sub> of Q2) and thus the capacitor

C1 used should be comparably rated. When operating with high voltage (V+ = 200 to 350 V) and large capacitors (>3000 μF), the power dissipated in the current limiting resistor R1 can be substantial, thus necessitating the illustrated 20 W rating. For longer charging times, switch S3 is closed, doubling the timing capacitor and the astable MV on time.

To discharge capacitor C1 and thereby generate the exponential surge current, the SCR must be fired. This trigger is generated by the positive going one second pulse from gate 1A being integrated by the R2C2 network, and then shaped by gates 1C and 1D. The net result of about 100 μs time delay from gate 1D ensures noncoincident timing conditions. This pulse output is then differentiated by C3-R3 with the positive going leading edge turning on Q3, Q4 and finally the SCR with about a 4 ms wide, 15 mA gate pulse. Consequently, the DUT is subjected to a surge current pulse whose magnitude is dictated by the voltage on the capacitor C1 and value of resistor R<sub>S</sub>, and also whose pulse width to the 10% point is 2.3 R<sub>S</sub>C1. For a fixed pulse width, the DUT is then stressed with increasing charge (by increasing V+) until failure occurs, usually a shorted device.

If the DUT is the SCR (or MOS SCR), the failed condition is obvious as the capacitor C1 will not be allowed to charge for subsequent timing cycles. However, when the DUT is the zener, rectifier, SIDAC or even an MOV, and the SCR is an adequately rated switch, the circuit will still discharge through the shorted DUT, but now the SCR alone will be stressed by the surge current. A shorted DUT can be detected by noting the voltage across the device during testing.

One problem encountered when stressing SCRs with high voltage is when the DUT fails short. The limiting resistor R1, which is only rated for 20 W, would now experience continuous power dissipation for the full On time — as much as 123 W ( $[350 \text{ V}]^2/1\text{K}$ ). To prevent this occurrence, the PR1 Short Protection Circuit is incorporated. Since this is only a problem when high V+'s (>100 V) are used, the circuit can be switched in or out by means of switch S2. When activated, this circuit monitors the voltage on capacitor C1 some time after the charging cycle begins. If the capacitor is charging, normal operation occurs. However, if the SCR DUT is shorted, the absence of voltage on the capacitor is detected and the system is disabled.

The circuit consists of one CMOS IC with NAND gates 2A and 2B comprising a one second monostable time delay MV and gates 2C and 2D forming a comparator and NAND gate, respectively.

The negative going, trailing edge of gate 2A is differentiated by R4-C4, and amplified by Q5 to form a positive, 10 ms wide pulse (delayed by 1 sec) to gate 2D input. If the capacitor C1 is shorted, gate 2C output is high, allowing the now negative pulse from gate 2D to turn on PNP transistor Q6 and SCR Q7. This latches the input to the astable MV gate 1A low, disabling the timing and consequently removing the power from R1. Resetting the tester for a new device is accomplished by depressing the pushbutton switch S1.

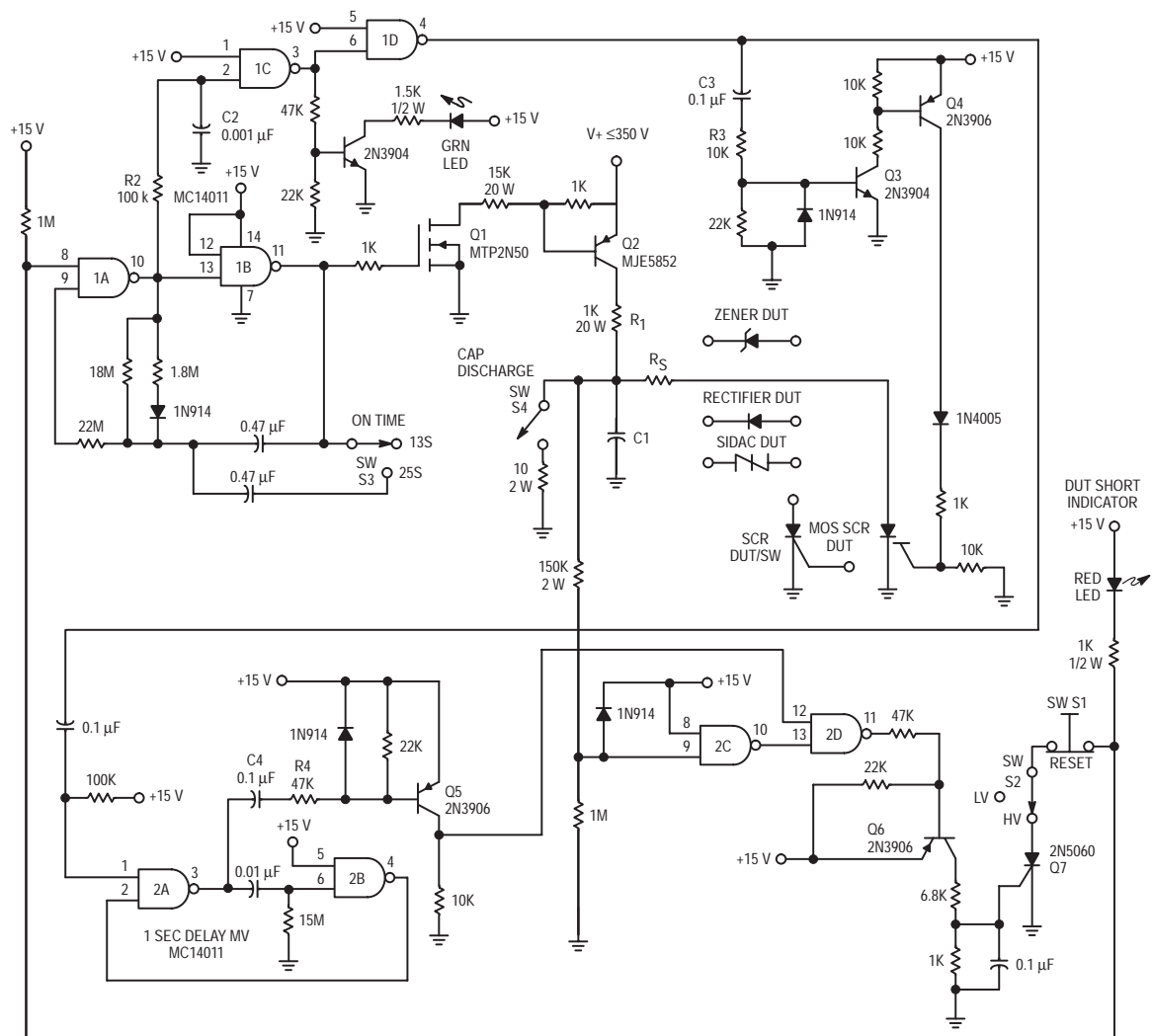


Figure 5. Exponential Surge Current Tester

Exponential surge current curves, as well as rectangular, are generated by destructive testing of at least several DUTs at various pulse widths and derating the final curve by perhaps 20–30%. These tests were conducted at low duty cycles (<2%). To ensure multicycle operation, the DUTs are then tested for about 1000 surges at a derated point on the curve.

voltages generally greater than 30 V. Also, since energy capability is related to die size, this parameter is also listed.

For several devices, both rectangular and exponential surge current pulses are listed. Other devices were tested with only rectangular pulses (where the junction temperature can be determined) and still others, whose applications include crowbars, with exponential current only.

### TEST RESULTS

In trying to make a comparison of the several different technologies of transient suppressors, some common denominator has to be chosen, otherwise, the amount of testing and data reduction becomes unwieldy. For this exercise, voltage was used, generally in the 20 V to 30 V range, although some of the more unique suppressors (SIDACs, MOS SCRs, SCRs) were tested at their operating voltage. As an example, the SIDAC trigger families of devices were tested with voltages greater than their breakover voltage (104 V to 280 V) and the SCRs were subjected to exponential surge currents derived from

### AVALANCHE RECTIFIER

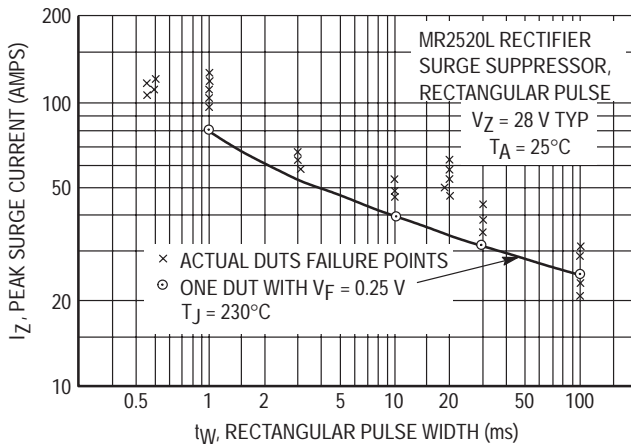
The Rectangular Surge Current Tester was originally designed for characterizing rectifier surge suppressors used in automotive applications. For this operation, where temperatures under the hood can reach well over 125°C, it is important to know the device junction temperature at elevated ambient temperature. Figures 6 and 7 describe the results of such testing on a typical suppressor, the 24 V–32 V MR2520L. It should be noted that these axial lead suppressors, as well as all other axial lead devices tested, were mounted between two spring loaded clips spaced 1 inch apart.

As shown in Figure 6 of the actual current failure points of the DUTs, at least four devices were tested at the various pulse widths,  $t_w$  (in this example from 0.5 ms to 100 ms).

Also shown in Figure 6 is the curve derived with a single DUT at an energy level just short of failure. This measurement was obtained by maintaining a constant rectifier forward voltage drop,  $V_F$  (0.25 V) for all pulse widths (junction temperature,  $T_J$  of 230°C) by varying the avalanche current. Thus, one device can be used, non-destructively, to generate the complete rectangular surge current curve.

It should also be pointed out that the definition for the exponential  $t_w$  in this article is the current discharge point to the 10% value of the peak test current  $I_{ZM}$ . Expressed in time constant  $\tau$ , this would be 2.3 RC. Some data sheets describe  $t_w$  to the 50% point of  $I_{ZM}$  (0.69  $\tau$ ) and others to 5  $\tau$ . To normalized these time scales (abscissa of curves) simply change the scales accordingly; i.e.,  $I_{ZM}/2$  pulse widths would be multiplied by 2.3/0.69 = 3.33 for  $t_w$  at 10% current pulses.

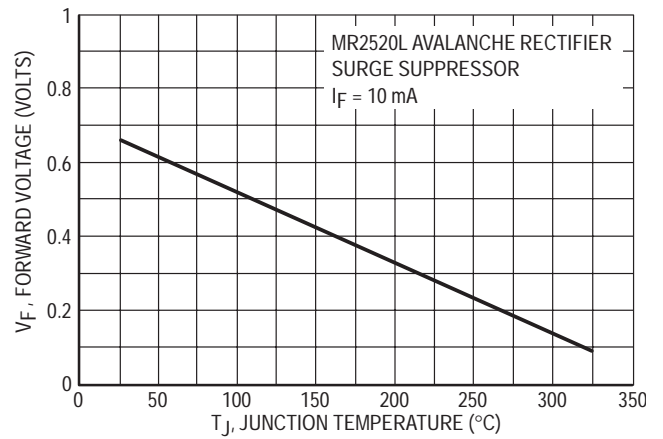
Figure 7a describes the actual temperature calibration curve (measured in a temperature chamber) of the MR2520L and Figure 7b, the junction temperature of the DUT at various 10 ms rectangular pulse current amplitudes. These temperatures are taken from the calibration curve (in actuality, an extremely linear curve), knowing the rectifier forward voltage drop immediately (within 100  $\mu$ s) after cessation of power. Note that the junction temperature just prior to device failure is about 290°C.



**Figure 6. Experimental Rectangular Surge Current Capability Of The MR2520L Rectifier Surge Suppressor**

**ZENER OVERVOLTAGE TRANSIENT SUPPRESSOR**

Illustrated in Figure 8 are the actual rectangular and exponential surge current curves of the P6KE30 overvoltage transient suppressor, an axial lead, Case 17, 30 V zener diode characterized and specified for surge currents. This device is specified for 600 W peak for a 1 ms exponential



**Figure 7a. Temperature Calibration Curve Of The MR2520L**

RECTANGULAR PULSE  
 $t_w = 10$  ms  
 $I_F = 10$  mA

$I_Z$ (A)	$V_F$ (V)	$T_J$ (°C)
1	0.64	25
10	0.57	75
20	0.48	120
30	0.36	180
40	0.25	230
50	0.15	290
55	0.10	DUT FAILED

**Figure 7b. Measured Forward Voltage**

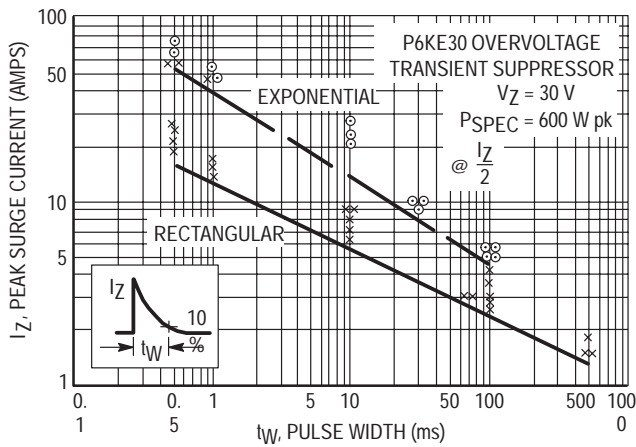
**Figure 7. Calculated Junction Temperature Of The MR2520L Surge Suppressor At Various Avalanche Currents**

pulse measured at  $I_{ZM}/2$ . From the exponential curve, it is apparent that the device is very conservatively specified. Also, the relative magnitudes of the two curves reflect the differences in the rms values of the two respective pulses.

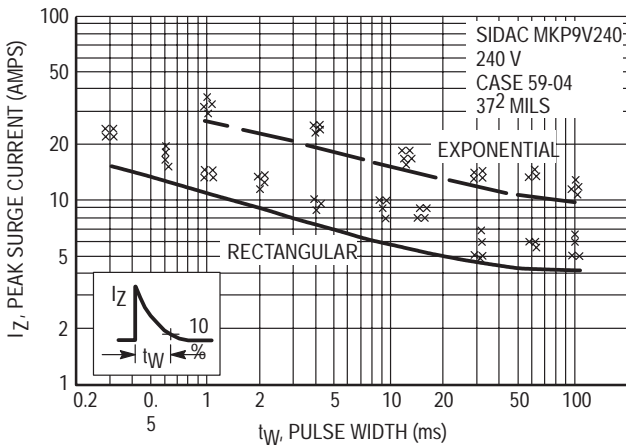
**SIDAC**

SIDACs are increasingly being used as overvoltage transient suppressors, particularly in telephone applications. Being a high voltage bilateral trigger device with relatively high current capabilities, they serve as a costeffective overvoltage protection device. As in other trigger devices, when the SIDACs breakover voltage is exceeded, the device switches to a low voltage conduction state, allowing an inordinate amount of surge current to be passed. This is well illustrated by the surge current curves of Figure 9 which describe the small die size ([37]<sup>2</sup>mil) axial lead, Case 59-04, MKP9V240 SIDAC. The curves show that this 240 V device was able to handle, to failure, as much as 31 A and 15 A, respectively, for 1 ms exponential and rectangular current pulses. Under the same pulse conditions, the large die ([78]<sup>2</sup>mil) MK1V270 SIDAC handled 170 A and 60 A, respectively, as shown in Table 2.





**Figure 8. Surge Current Capability Of The P6KE30 Overvoltage Transient Suppressor As A Function Of Exponential & Rectangular Pulse Widths**



**Figure 9. Measured Surge Current To Failure Of A SIDAC MKP9V240**

### OVERALL RATINGS

The compilation of all of the testing to date on the various transient suppressors is shown in Tables 1 and 2. Table 1 describes the zener suppressors, avalanche rectifiers and MOVs, comparing the die size and normalized costs (referenced to the MOV V39MA2A). From this data, the designer can make a cost/performance judgment.

Of interest is that the small pellet MOV is not the least expensive device. The P6KE30 overvoltage transient suppressor costs about 85% of the MOV, yet it can handle about three times the current (2.5 A to 0.7 A) for a 100 ms rectangular pulse. Under these conditions, the resultant clamping voltages for the zener and MOV were 32 V and 60 V respectively.

Also shown in the table is a 1.5 W zener diode specified for zener applications. This low surge current device costs three times the MOV, illustrating that tight tolerance zener diodes are not cost effective and that the user should use devices designed and priced specifically for the suppressor application.

Thyristor type surge suppressors are shown in Table 2. They include four SIDAC series, two SCRs designed and characterized specifically for crowbar applications and also the MOS SCR MCR1000. The MOS SCR, a process variation of the vertical structure power MOSFET, combines the input characteristics of the FET with the latching action of an SCR.

All devices were surge current tested with the resultant peak currents being impressively high. The TO-220 (150)<sup>2</sup> mil SCR MCR69 for example, reached peak current levels approaching 700 A for a 1 ms exponential pulse. The guaranteed, derated, time base translated curves for the crowbar SCR family of devices are shown in Figure 10, as is the MK1V SIDAC in Figure 11.

Figures 12A–C describe the guaranteed, reverse surge design limits for the avalanche rectifier devices. These three figures illustrate, respectively, the peak current, power and energy capabilities of these overvoltage transient suppressors derived from exponential testing. The peak power,  $P_{pk}$ , ordinate of the curve is simply the product of the derated  $I_Z$  and  $V_Z$  and the energy curve, the product of  $P_{pk}$  and  $t_W$ .

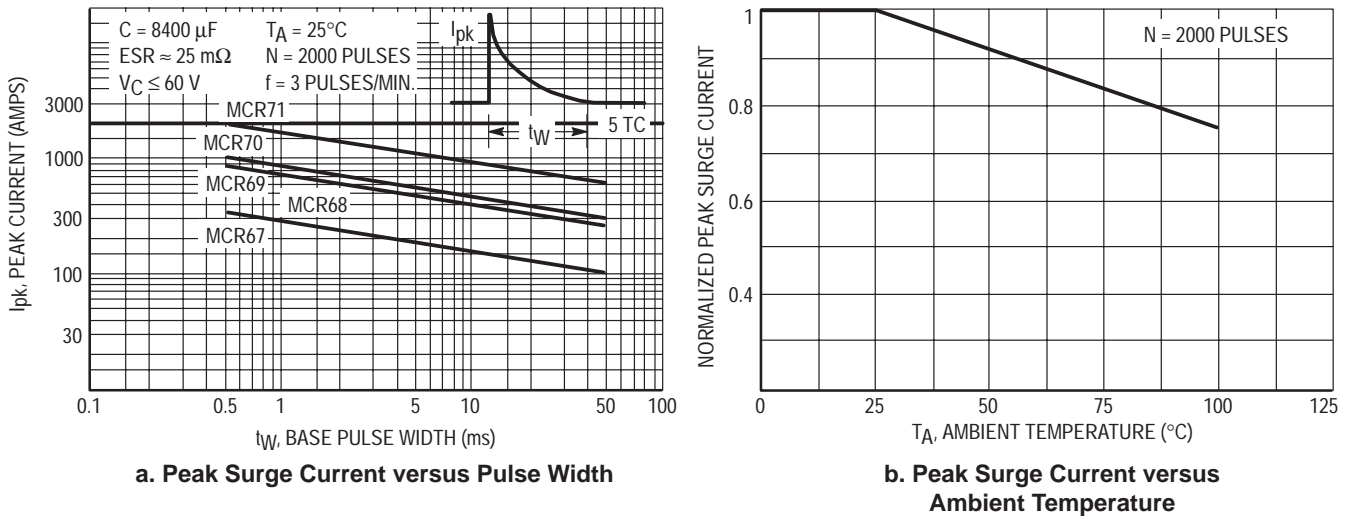


Figure 10. SCR Crowbar Derating Curves

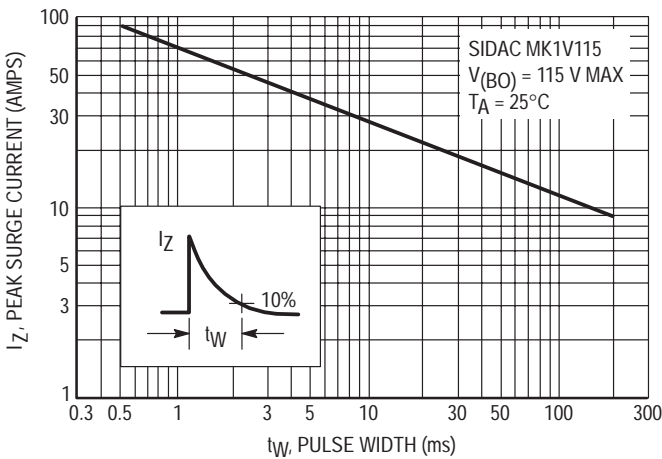


Figure 11. Exponential Surge Current Capability Of The MK1V SIDAC, Pulse Width versus Peak Current

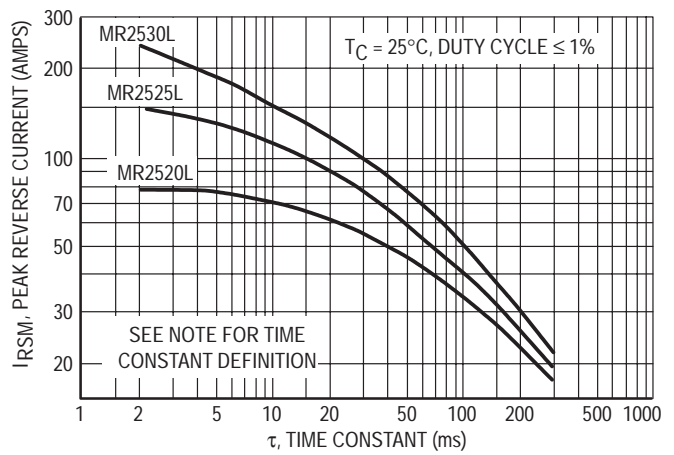


Figure 12a. Peak Current

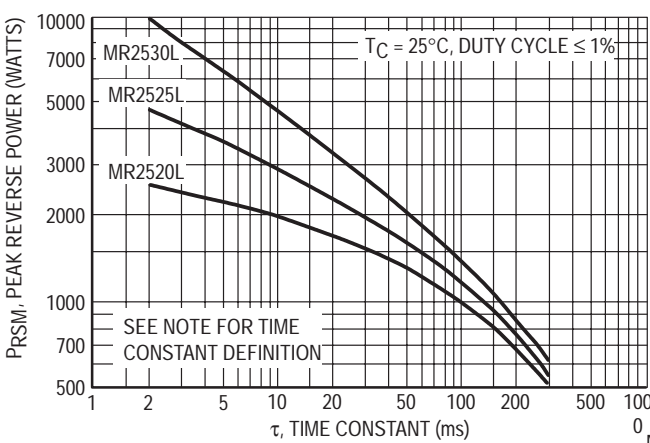


Figure 12b. Peak Power

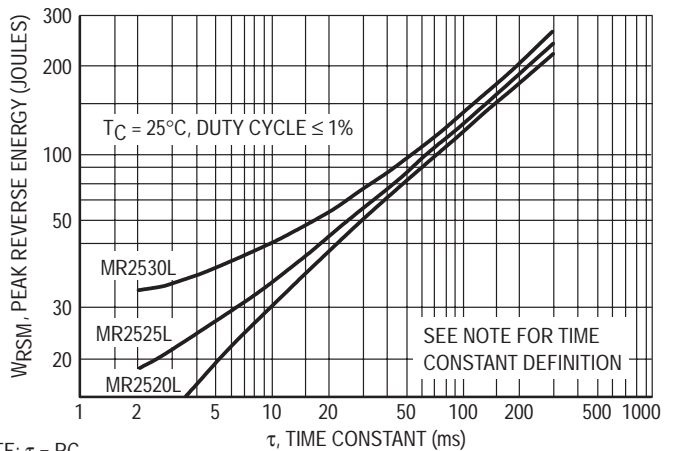


Figure 12c. Energy

Figure 12. Guaranteed Reverse Surge Design Limits for the MR2525L & MR2530L Overload Transient Suppressors

**Table 1. Measured Surge Current Capability of Transient Suppressors**

Device Type	Title	Part No.	Case	Spec.		Die Size	Peak Current at Pulse Widths, I <sub>pk</sub> (Amps)								Clamping Factor $\frac{V_{1ms}}{V_{100ms}}$		Norm. Cost *
				Volt	Power (Energy)		1 ms		10 ms		20 ms		100 ms		Exp.	Rect.	
							Exp.	Rect.	Exp.	Rect.	Exp.	Rect.	Exp.	Rect.			
Avalanche Rectifier	Surge Supp., Overvoltage Transient Suppressor	MR2520L	194-05	24-32 V	2.5 KW Peak	150 <sup>2</sup> mil		85 A		40		30		18	$\frac{27 V}{22 V} = 1.2$	4.0	
		MR2525L		24-32 V	10 KW Peak	196 <sup>2</sup> mil		150 A		70		54		37	$\frac{31}{23} = 1.3$		
Zener	1.5 W Zener Diode	1N5936A	DO-41	30 V	1.5 W Cont.	37 <sup>2</sup> mil	12 A	5	6	2.5	5	2	3	1.3	$\frac{41}{30} = 1.4$	3.2	
		1N5932A		20 V			23 A	6	10	2.8	7	2.3	5	1.4	$\frac{28}{23} = 1.2$		
	Overvoltage Transient Suppressor	P6KE30	17	30 V	600 W Peak	60 <sup>2</sup> mil	43 A	14	14	5	10	4.5	5	2.5	$\frac{41}{32} = 1.3$	0.85	
		P6KE10		10 V				24 A		12		9		5.5	$\frac{16}{13} = 1.2$		
	MOSORB	1.5KE30	41A-02	30 V	1500 W Peak	104 <sup>2</sup> mil		35 A		10				4	$\frac{35}{33} = 1.1$	1.8	
		1.5KE24		24 V				45 A		14				6	$\frac{30 V}{28 V} = 1.1$		
MOV**	Metal Oxide Varistor	V39MA2A	Axial Lead	28 V	(0.16 Joules)	3 mm		9 A		5				0.7	$\frac{80 V}{60 V}$ $\frac{6 A}{0.7 A}$	1.0	
		V33ZA1	Radial Lead	26 V	(1.0 Joules)	7 mm				35				4 A	$\frac{105 V}{80 V}$ $\frac{35 A}{4 A}$	1.4	

\*\*G.E.

**Table 2. Measured Surge Current Of Thyristor Type Devices**

Technology	Device	Voltage Ratings	Case	Die Size	I <sub>pk</sub> @ t <sub>w</sub>				Norm Cost *
					1 ms		10 ms		
					Exponent.	Rectang.	Exponent.	Rectang.	
SIDAC	MKP9V130 Series	104 V-135 V	59-04	37 <sup>2</sup> mil	40 A	13 A	16 A	8 A	0.87
	MKP9V240 Series	220 V-280 V			31 A	15 A	20 A	8 A	
	MK1V135 Series	120 V-135 V	267-01	78 <sup>2</sup> mil	140 A	80 A	55 A	30 A	1.1
	MK1V270 Series	220 V-280 V			170 A	60 A	90 A	28 A	
SCR	MCR68 Series	25 V-400 V	TO-220	92 <sup>2</sup> mil	300 A		170 A	1.2	
	MCR69 Series			150 <sup>2</sup> mil	700 A		400 A	1.9	
MOS SCR	MCR1000 Series	200 V-600 V		127 mil x 183 mil	250 A		170 A	9.3	

\*Normalized to G.E. MOV V39MA2A, Qty 1-99, 1984 Price

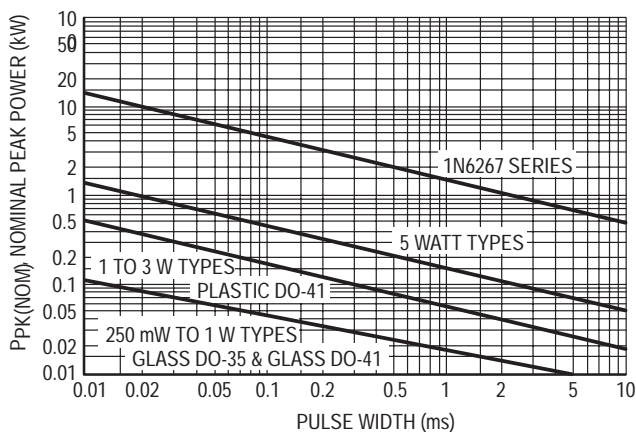
Additionally, the published non-repetitive peak power ratings of the various zener diode packages are illustrated in Figure 13. Figure 14 describes the typical derating factor for repetitive conditions of duty cycles up to 20%. Using these two empirically derived curves, the designer can then determine the proper zener for the repetitive peak current conditions.

At first glance the derating of curves of Figure 14 appear to be in error as the 10 ms pulse has a higher derating factor than the 10 μs pulse. However, when the mathematics of multiplying the derating factor of Figure 14 by the peak power value of Figure 13 is performed, the resultant respective power and current capability of the device follows the

expected trend. For example, for a 5 W, 20 V zener operating at a 1.0% duty cycle, the respective derating factors for 10 μs and 10 ms pulses are 0.08 and 0.47. The non-repetitive peak power capabilities for these two pulses (10 μs and 10 ms) are about 1300 W and 50 W respectively, resulting in repetitive power and current capabilities of about 104 W and 24 W and consequently 5.2 A and 1.2 A.

**MOV**

All of the surge suppressors tested with the exception of the MOV are semiconductors. The MOV is fabricated from a ceramic (ZnO), non-linear resistor. This device has wide acceptance for a number of reasons, but for many



Power is defined as  $V_Z(NOM) \times I_Z(PK)$  where  $V_Z(NOM)$  is the nominal zener voltage measured at the low test current used for voltage classification.

Figure 13. Peak Power Ratings of Zener Diodes

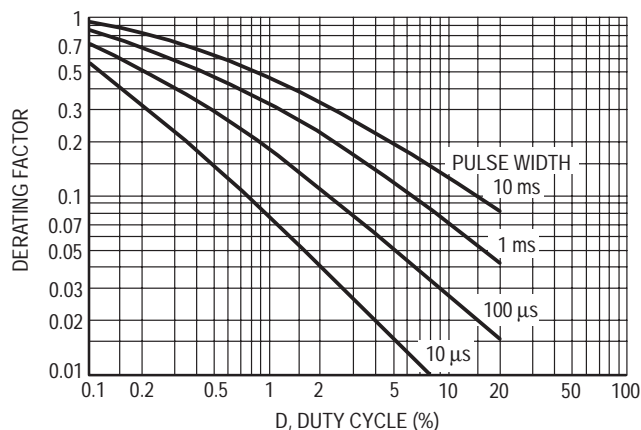
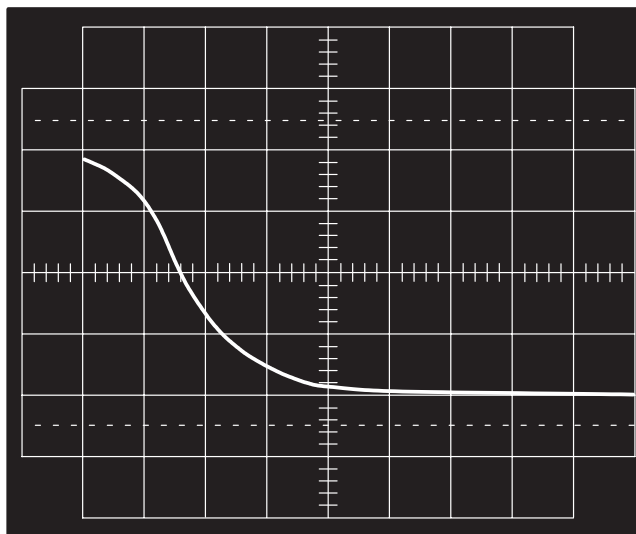


Figure 14. Typical Derating Factor for Duty Cycle

applications, particularly those requiring good clamping factors, the MOV is found lacking; (clamping factor is defined as the ratio of  $V_Z$  at the test current to that at 1.0 mA). This is photographically illustrated in Figure 15 which compares a 27 V zener (1N6281) with a 27 V MOV (V27ZA4). The input waveform, through a source impedance resistance to the DUTs, was an exponentially decaying voltage waveform of 90 V peak. Figures 15A and B compare the output waveforms (across the DUTs) when the source impedance was 500 Ω and Figures 15C and D for a 50 Ω condition. The zener clamped at about 27 V for both impedances whereas the MOV was about 40 V and 45 V respectively.

Surge current capabilities of a comparably powered MOV were also determined, as shown in the curve of Figure 16. Although the MOV, a V39MA2A, is specified as a 28 V

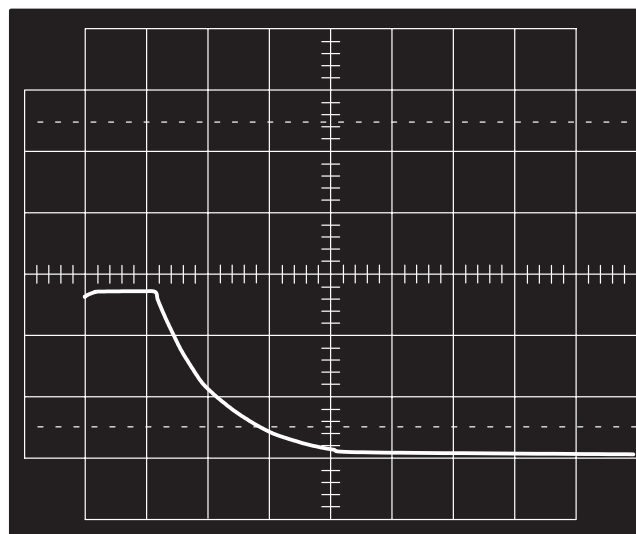
SOURCE IMPEDANCE  $R_S = 500 \Omega$



27 V MOV  
G.E. V27ZA4, 4 JOULES CAPABILITY

Figure 15a.

SOURCE IMPEDANCE  $R_S = 500 \Omega$



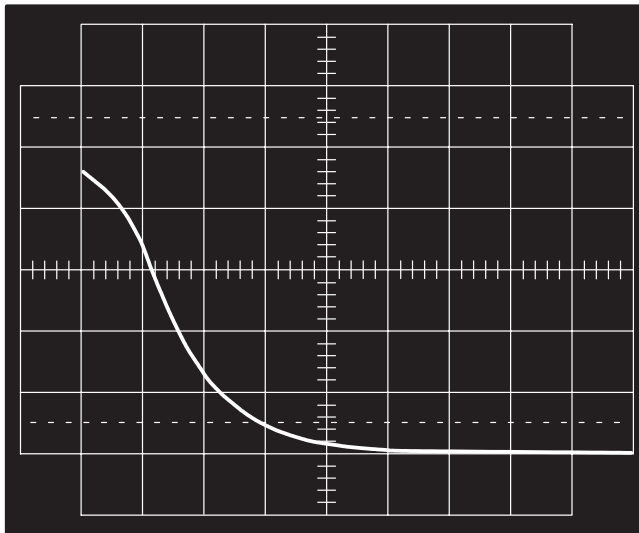
27 V ZENER DIODE  
MOTOROLA 1N6281, APPROX. 1.5 JOULES

Figure 15b.

continuous device (39 V  $\pm 10\%$  at 1 mA) at the pulse widths and currents tested, the resultant voltage  $V_Z$  across the MOV — 80 V at about 6 A — necessitated a high voltage fixture. This was accomplished with a circuit similar to that of Figure 1B.

But MOVs do have their own niche in the marketplace, as described in Table 3, the Relative Features of MOVs and MOSORBs.

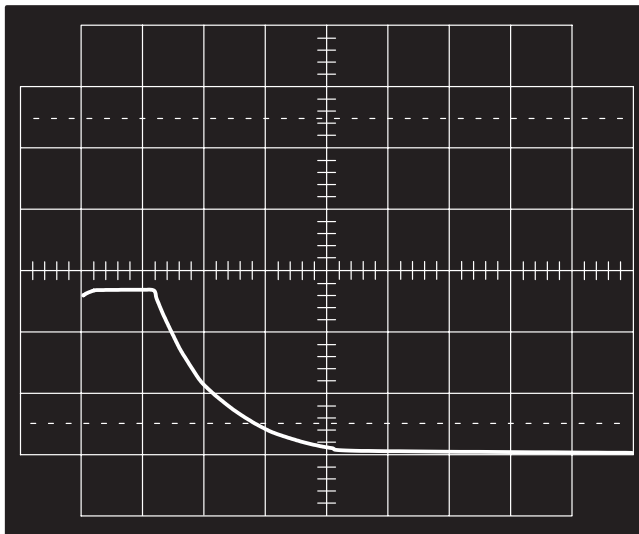
SOURCE IMPEDANCE  $R_S = 50 \Omega$



27 V MOV

Figure 15c.

SOURCE IMPEDANCE  $R_S = 50 \Omega$



27 V ZENER DIODE

Figure 15d.

Figure 15. Clamping Characteristics of a 27 V Zener Diode and 27 V MOV

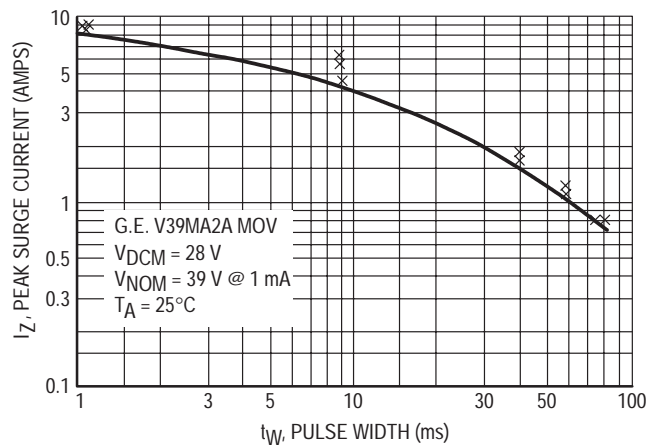


Figure 16. Rectangular Surge Current Capability Of The V39MA2A MOV

Table 3. Relative Features of MOVs and MOSORBs

MOV	MOSORB/Zener Transient Suppressor
High Clamping Factor	Very good clamping close to the operating voltage.
Symmetrically bidirectional	Standard parts perform like standard zeners. Symmetrical bidirectional devices available for many voltages.
Energy capability per dollar usually much greater than a silicon device. However, if good clamping is required a higher energy device would be needed, resulting in higher cost.	Good clamping characteristics could reduce overall cost.
Inherent wear out mechanism, clamp voltage degrades after every pulse, even when pulsed below rated value.	No inherent wear out mechanism.
Ideally suited for crude AC line protection.	Ideally suited for precise DC protection.
High single-pulse current capability.	Medium multiple-pulse current capability.
Degrades with overstress.	Fails short with overstress.
Good high voltage capability.	Limited high voltage capability unless series devices are used.
Limited low voltage capability.	Good low voltage capability.

### **SUMMARY**

The surge current capabilities of low energy overvoltage transient suppressors have been demonstrated, including cost/performance comparison of rectifiers, zeners, thyristor type suppressors, and MOVs. Both rectangular and exponential testing have been performed with the described testers. Additionally, the Rectangular Current Surge Tester has the capability of measuring the diode junction temperature of zeners and rectifiers at various power levels, thus establishing safe operating limits.

### **REFERENCES**

1. Cherniak, S., *A Review of Transients and Their Means of Suppression*, Motorola Application Note AN843.
2. Wilhardt, J., *Transient Power Capability of Zener Diodes*, Motorola Application Note AN784.
3. Pshanenich, A., *Characterizing the SCR for Crowbar Applications*, Motorola Application Note AN879.
4. Pshanenich, A., *The SIDAC, A New High Voltage Trigger that Replaces Circuit Complexity and Cost*, Motorola Engineering Bulletin EB-106.
5. General Electric, *Transient Voltage Suppression Manual*, Second Edition.

# MEASUREMENT OF ZENER VOLTAGE TO THERMAL EQUILIBRIUM WITH PULSED TEST CURRENT

Prepared by  
Herb Saladin  
Discrete Power Application Engineering

## INTRODUCTION

This paper discusses the zener voltage correlation problem which sometimes exists between the manufacturer and the customer's incoming inspection. A method is shown to aid in the correlation of zener voltage between thermal equilibrium and pulse testing. A unique double pulsed sample and hold test circuit is presented which improves the accuracy of correlation.<sup>1</sup>

Several zener voltages versus zener pulsed test current curves are shown for four package styles. An appendix is attached for incoming inspection groups giving detailed information on tolerances involved in correlation.

For many years the major difficulty with zener diode testing seemed to be correlation of tight tolerance voltage specifications where accuracy between different test setups was the main problem. The industry standard and the EIA Registration system adopted thermal equilibrium testing of zener diodes as the basic test condition unless otherwise specified. Thermal equilibrium was chosen because it was the most common condition in the final circuit design and it was the condition that the design engineers needed for their circuit design and device selection. Thermal equilibrium testing was also fairly simple to set-up for sample testing at incoming inspection of standard tolerance zeners.

In recent years with the advent of economical computerized test systems many incoming inspection areas have implemented computer testing of zener diodes which has been generating a new wave of correlation problems between customers and suppliers of zener diodes.

The computerized test system uses short duration pulse test techniques for testing zener diodes which does not directly match the industry standard thermal equilibrium test specifications.

This paper was prepared in an attempt to clarify the differences between thermal equilibrium and short duration pulse testing of zener diodes, to provide a test circuit that allows evaluation at various pulse widths and a suggested procedure for incoming inspection areas that will allow meaningful correlation between thermal equilibrium and pulse testing.

In the measurement of zener voltage ( $V_Z$ ), the temperature coefficient effect combined with test current heating can present a problem if one is attempting to correlate  $V_Z$  measurements made by another party (Final Test, Quality Assurance or Incoming Inspection).<sup>2</sup> This paper is intended as an aid in determining  $V_Z$  at some test current ( $I_{ZT}$ ) pulse width other than the pulse width used by the manufacturer.

Thermal equilibrium (TE) is reached when diode junction temperature has stabilized and no further change will occur in  $V_Z$  if the  $I_{ZT}$  time is increased.<sup>2</sup> This absolute value can vary depending on the mounting method and amount of heatsinking. Therefore, thermal equilibrium conditions have to be defined before meaningful correlation can exist.

Normalized  $V_Z$  curves are shown for four package styles and for three to five voltage ratings per package. Pulse widths from 1 ms up to 100 seconds were used to arrive at or near thermal equilibrium for all packages with a given method of mounting.

## Mounting

There are five conditions that can affect the correlation of  $V_Z$  measurements and are: 1) instrumentation, 2)  $T_A$ , 3)  $I_{ZT}$  time, 4)  $P_D$  and 5) mounting. The importance of the first four conditions is obvious but the last one, mounting, can make the difference between good and poor correlation. The mounting can have a very important part in  $V_Z$  correlation as it controls the amount of heat and rate of heat removal from the diode by the mass and material in contact with the diode package.

Two glass axial lead packages (DO-35 and DO-41), curves (Figures 5 and 6) were measured with standard Grayhill clips and a modified version of the Grayhill clips to permit lead length adjustment.

## Test Circuit

The test circuit (Figure 8) consists of standard CMOS logic for pulse generation, inverting and delaying. The logic drives three bipolar transistors for generation of the power pulse for  $I_{ZT}$ .  $V_Z$  is fed into a unique sample and hold (S/H) circuit consisting of two high input impedance operational amplifiers and a field effect transistor switch.

For greater accuracy in  $V_Z$  measurements using a single pulse test current, the FET switch is double pulsed. Double pulsing the FET switch for charging the S/H capacitor increases accuracy of the charge on the capacitor as the second pulse permits charging the capacitor closer to the final value of  $V_Z$ .

The timing required for the two pulse system is shown in waveform G-3C whereby the initial sample pulse is delayed from time zero by a fixed 100  $\mu$ s to allow settling time and the second pulse is variable in time to measure the analog input at that particular point. The power pulse (waveform G-2D) must also encompass the second sample pulse.

To generate these waveforms, four time delay monostable multivibrators (MV) are required. Also, an astable MV, is required for free-running operation; single pulsing is simply initiated by a push-button switch S1. All of the pulse generators are fashioned from two input, CMOS NOR gates; thus three quad gate packages (MC14001) are required. Gates 1A and 1B form a classical CMOS astable MV clock and the other gates (with the exception of Gate 2D) comprise the two input NOR gate configured monostable MV's. The Pulse Width variable delay output (Gate 1D) positions the second sample pulse and also triggers the 100  $\mu$ s Delay MV and the 200  $\mu$ s Extended Power Pulse MV, The respective positive going outputs from gates 3A and 2C are diode NOR'ed to trigger the Sample Gate MV whose output will consequently be the two sample pulses. These pulses then turn on the PNP transistor Q1 level translator and the following S/H N-channel FET series switch Q2. Op amps U4 and U5, configured as voltage followers, respectively provide the buffered low output impedance drive for the input and output of the S/H. Finally, the pulse extended Power Gate is derived by NORing (Gate 2D) the Pulse Width Output (Gate 1D) with the 200  $\mu$ s MV output (Gate 2C). This negative aging gate then drives the Power Amplifier, which, in turn, powers the D.U.T. The power amplifier configuration consists of cascaded transistors Q3–Q5, scaled for test currents up to 2 A.

Push button switch (S4) is used to discharge the S/H capacitor. To adjust the zero control potentiometer, ground the non-inverting input (Pin 3) of U4 and discharge the S/H capacitor.

### Testing

The voltage  $V_{CC}$ , should be about 50 volts higher than the D.U.T. and with  $R_C$  selected to limit the  $I_{ZT}$  pulse to a value making  $V_{ZT} I_{ZT} = 1/4 P_D$  (max), thus insuring a good current source. All testing was performed at a normal room temperature of 25°C. A single pulse (manual) was used and at a low enough rate that very little heat remained from the previous pulse.

The pulse width MV (1C and 1D) controls the width of the test pulse with a selector switch S3 (see Table 1 for capacitor values). Fixed widths in steps of 1, 3 and 5 from 1 ms to 10 seconds in either a repetitive mode or single pulse is available. For pulse widths greater than 10 seconds, a stop watch was used with push button switch (S1) and with the mode switch (S2) in the > 10 seconds position.

For all diodes with  $V_Z$  greater than about 6 volts a resistor voltage divider is used to maintain an input of about 6 V to the first op amp (U4) so as not to overload or saturate this device. The divider consists of R5 and R6 with R6 being 10 k $\Omega$  and R5 is selected for about a 6 V input to U4. Precision resistors or accurate known values are required for accurate voltage readout.

Table 1. S3 — Pulse Width

Switch Position	*C( $\mu$ F)	t(ms)
1	0.001	1
2	0.004	3
3	0.006	5
4	0.01	10
5	0.04	30
6	0.06	50
7	0.1	100
8	0.4	300
9	0.6	500
10	1.0	1K
11	1.2	3K
12	6.0	5K
13	10	10K

\*Approximate Values

### Using Curves

Normalized  $V_Z$  versus  $I_{ZT}$  pulse width curves are shown in Figure 1 through 6. The type of heatsink used is shown or specified for each device package type. Obviously, it is beyond the scope of this paper to show curves for every voltage rating available for each package type. The object was to have a representative showing of voltages including when available, one diode with a negative temperature coefficient (TC).

These curves are actually a plot of thermal response versus time at one quarter of the rated power dissipation. With a given heatsink mounting,  $V_Z$  can be calculated at some pulse width other than the pulse width used to specify  $V_Z$ .

For example, refer to Figure 5 which shows normalized  $V_Z$  curves for the axial lead DO-35 glass package. Three mounting methods are shown to show how the mounting effects device heating and thus  $V_Z$ . Curves are shown for a 3.9 V diode (1N5228B) which has a negative TC and a 12 V diode (1N5242B) having a positive TC.

In Figure 5, the two curves generated using the Grayhill mountings are normalized to  $V_Z$  at TE using the Motorola fixture. There is very little difference in  $V_Z$  at pulse widths up to about 10 seconds and mounting only causes a very small error in  $V_Z$ . The maximum error occurs at TE between mountings and can be excessive if  $V_Z$  is specified at TE and a customer measures  $V_Z$  at some narrow pulse width and does not use a correction factor.

Using the curves of Figure 5,  $V_Z$  can be calculated at any pulse width based upon the value of  $V_Z$  at TE which is represented by 1 on the normalized  $V_Z$  scale. If the 1N5242B diode is specified at 12 V  $\pm$  1.0% at 90 seconds which is at TE,  $V_Z$  at 100 ms using either of the Grayhill clips curves would be 0.984 of the  $V_Z$  value at TE or 1 using the Motorola fixture curve. If the negative TC diode is specified at 3.9 V  $\pm$  1.0% at TE (90 seconds),  $V_Z$  at 100 ms would be 1.011 of  $V_Z$  at TE (using Motorola fixture curve) when using the Grayhill Clips curves.



In using the curves of Figure 5 and 6, it should be kept in mind that  $V_Z$  can be different at TE for the three mountings because diode junction temperature can be different for each mounting at TE which is represented by 1 on the  $V_Z$  normalized scale. Therefore, when the correlation of  $V_Z$  between parties is attempted, they must use the same type of mounting or know what the delta  $V_Z$  is between the two mountings involved.

The Grayhill clips curves in Figure 6 are normalized to the Motorola fixture at TE as in Figure 5. Figures 1 through 4 are normalized to  $V_Z$  at TE for each diode and would be used as Figures 5 and 6.

Measurement accuracy can be affected by test equipment, power dissipation of the D.U.T., ambient temperature and accuracy of the voltage divider if used on the input of the first op-amp (U4). The curves of Figures 1 through 6 are for an ambient temperature of 25°C, at other ambients,  $\theta V_Z$  has to be considered and is shown on the data sheet for the 1N5221B series of diodes.  $\theta V_Z$  is expressed in mV/°C and for the 1N5228B diode is about -2 mV/°C and for the 1N5242B, about 1.6 mV/°C. These values are multiplied by the difference in  $T_A$  from the 25°C value and either subtracted

or added to the calculated  $V_Z$  depending upon whether the diode has a negative or positive TC.

### General Discussion

The TC of zener diodes can be either negative or positive, depending upon die processing. Generally, devices with a breakdown voltage greater than about 5 V have a positive TC and diodes under about 5 V have a negative TC.

### Conclusion

Curves showing  $V_Z$  versus  $I_{ZT}$  pulse width can be used to calculate  $V_Z$  at a pulse width other than the one used to specify  $V_Z$ . A test circuit and method is presented to obtain  $V_Z$  with a single pulse of test current to generate  $V_Z$  curves of interest.

### References

1. Al Pshaenich, "Double Pulsing S/H Increases System Accuracy"; Electronics, June 16, 1983.
2. Motorola Zener Diode Manual, Series A, 1980.

FIGURES 1 thru 8 — Conditions: Single Pulse,  $T_A = 25^\circ\text{C}$ ,  $V_Z I_{ZT} = 1/4 P_D$  (Max) Each device normalized to  $V_Z$  at TE.

AXIAL LEAD PACKAGES: MOUNTING STANDARD GRAYHILL CLIPS

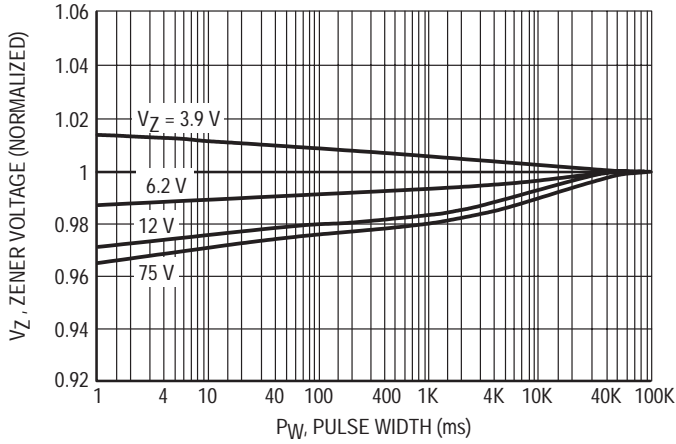


Figure 1. DO-35 (Glass) 500 mW Device

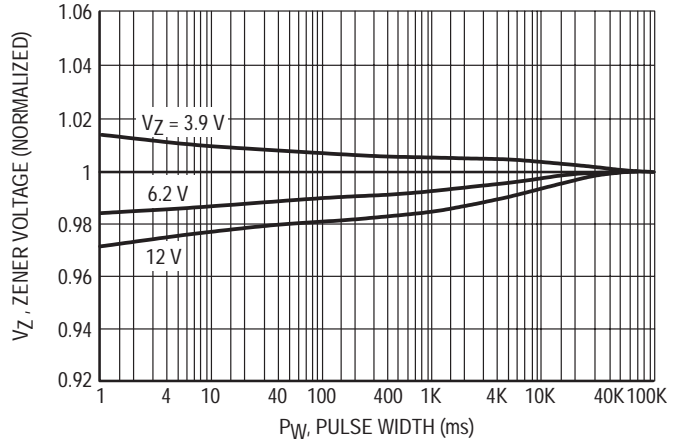


Figure 2. DO-41 (Glass) 1 Watt Device

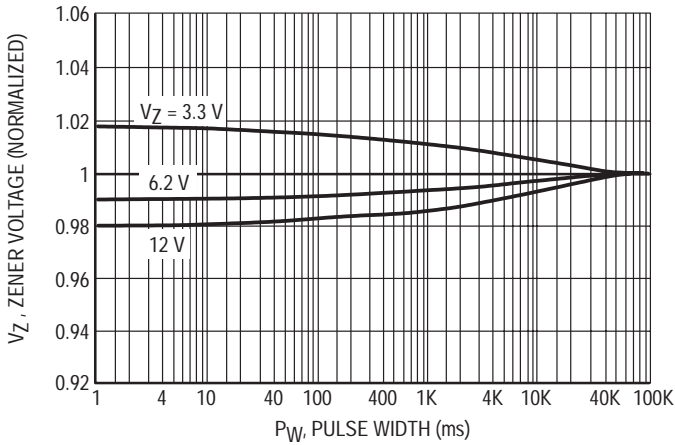


Figure 3. DO-41 (Plastic) 1.5 Watt Device

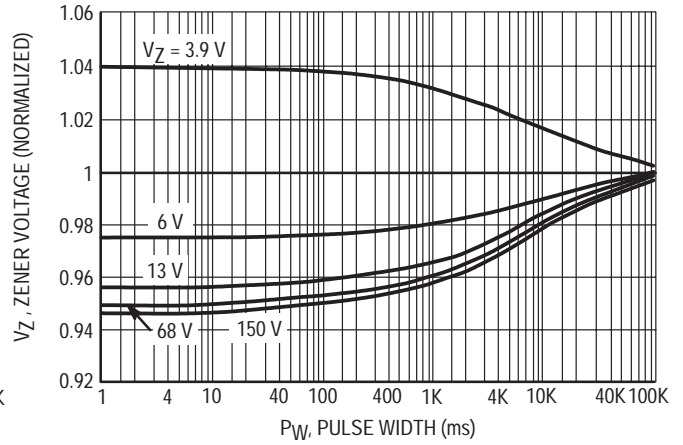


Figure 4. Case 17 (Plastic) 5 Watt Device

THREE MOUNTING METHODS: DO-35 AND DO-41

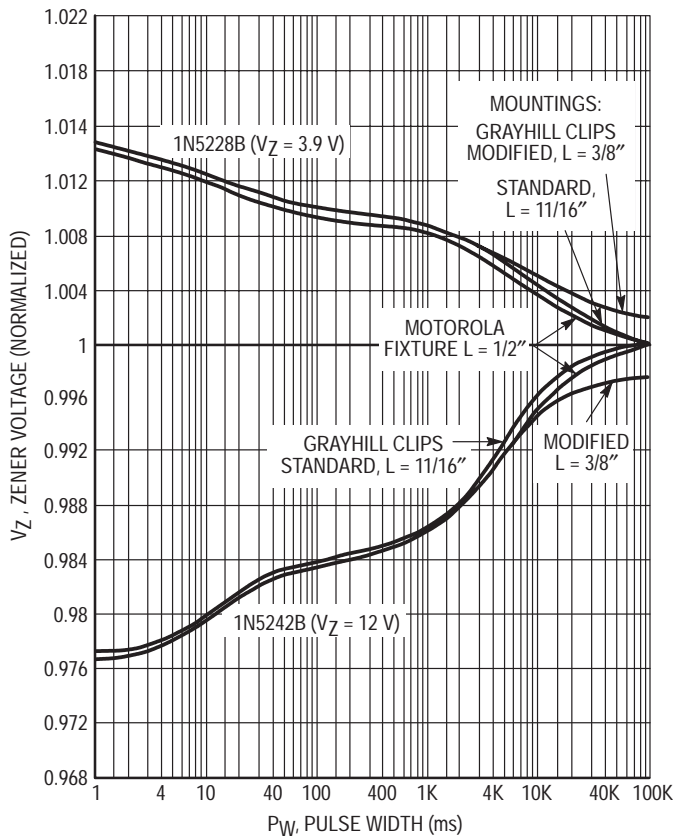


Figure 5. DO-35 (Glass) 500 mW Device

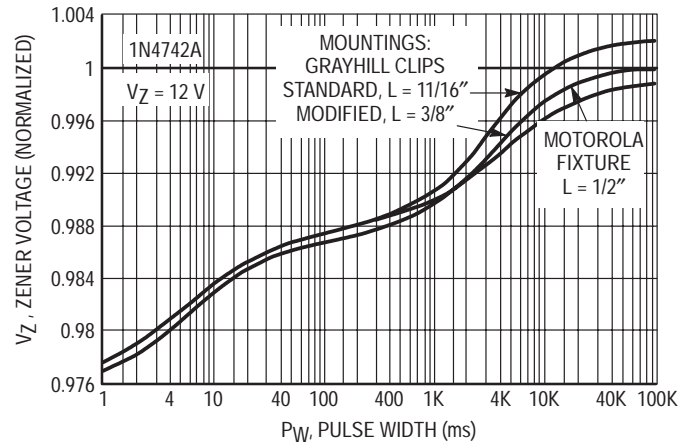


Figure 6. DO-41 (Glass) 1 Watt Device

MOUNTING FIXTURE

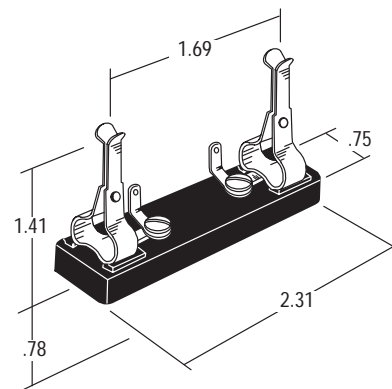


Figure 7. Standard Grayhill Clips

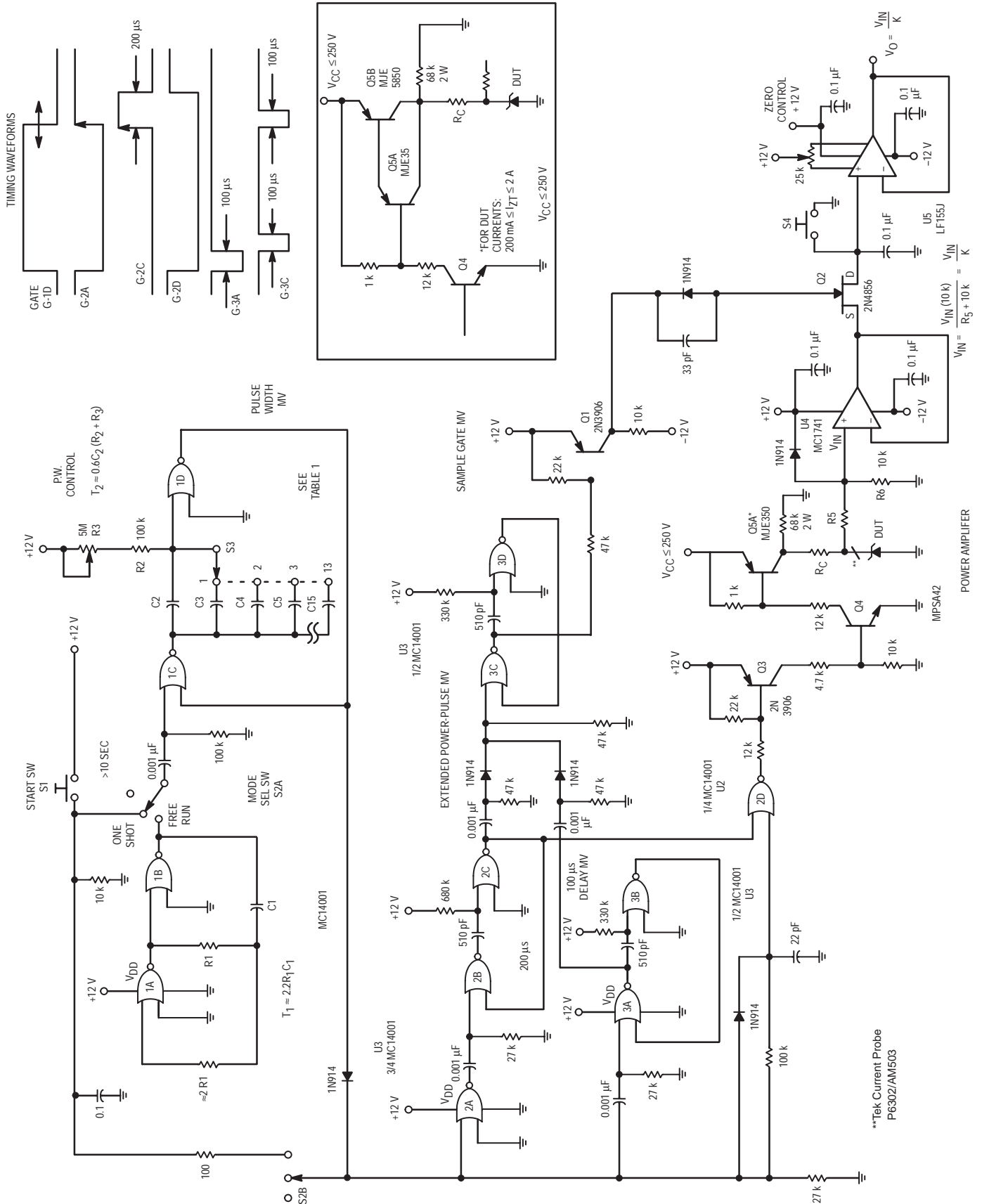


Figure 8. Zener Voltage Double Pulsing S/H Test Circuit

## APPENDIX A

### Recommended Incoming Inspection Procedures

#### Zener Voltage Testing

#### Pulsed versus Thermal Equilibrium

This section is primarily for use of incoming inspection groups. The subject covered is the measurement of zener voltage ( $V_Z$ ) and the inherent difficulty of establishing correlation between supplier and buyer when using pulsed test techniques. This difficulty, in part, is due to the interpretation of the data taken from the variety of available testers and in some cases even from the same model types. It is therefore, our intent to define and reestablish a standardized method of measurement to achieve correlation no matter what test techniques are being used. This standardization will guarantee your acceptance of good product while maintaining reliable correlation.

#### DEFINITION OF TERMS

##### Temperature Coefficient (TC):

The temperature stability of zener voltages is sometimes expressed by means of the temperature coefficient (TC). This parameter is usually defined as the percent voltage change across the device per degree centigrade, or as a specific voltage change per degree centigrade. Temperature changes during test are due to the self heating effects caused by the dissipation of power in the zener junction. The  $V_Z$  will change due to this temperature change and will exhibit a positive or negative TC, depending on the zener voltage. Generally, devices with a zener voltage below five volts will have a negative TC and devices above five volts will exhibit a positive TC.

##### Thermal Equilibrium (TE)

Thermal equilibrium (TE) is reached when the diode junction temperature has stabilized and no further change will occur. In thermal equilibrium, the heat generated at the junction is removed as rapidly as it is created, hence, no further temperature changes.

#### MEASURING ZENER VOLTAGE

The zener voltage, being a temperature dependent parameter, needs to be controlled for valid  $V_Z$  correlation. Therefore, so that a common base of comparison can be established, a reliable measure of  $V_Z$  can only occur when all possible variables are held constant. This common base is achieved when the device under test has had sufficient time to reach thermal equilibrium (heatsinking is required to stabilize the lead or case temperature to a specified value

for stable junction temperatures). The device should also be powered from a constant current source to limit changes of power dissipated and impedance.

All of the above leads us to an understanding of why various pulse testers will give differing  $V_Z$  readings; these differences are, in part, due to the time duration of test (pulse width), duty cycle when data logging, contact resistance, tolerance, temperature, etc. To resolve all of this, one only needs a reference standard to compare their pulsed results against and then adjust their limits to reflect those differences. It should be noted that in a large percentage of applications the zener diode is used in thermal equilibrium.

Motorola guarantees all of its axial leaded zener products (unless otherwise specified) to be within specification ninety (90) seconds after the application of power while holding the lead temperatures at  $30 \pm 1^\circ\text{C}$ , 3/8 of an inch from the device body, any fixture that will meet that criteria will correlate.  $30^\circ\text{C}$  was selected over the normally specified  $25^\circ\text{C}$  because of its ease of maintenance (no environmental chambers required) in a normal room ambient. A few degrees variation should have negligible effect in most cases. Hence, a moderate to large heatsink in most room ambients should suffice.

Also, it is advisable to limit extraneous air movements across the device under test as this could change thermal equilibrium enough to affect correlation.

#### SETTING PULSED TESTER LIMITS

Pulsed test techniques do not allow a sufficient time for zener junctions to reach TE. Hence, the limits need to be set at different values to reflect the  $V_Z$  at lower junction temperatures. Since there are many varieties of test systems and possible heatsinks, the way to establish these limits is to actually measure both TE and pulsed  $V_Z$  on a serialized sample for correlation.

The following examples show typical delta changes in pulsed versus TE readings. The actual values you use for pulsed conditions will depend on your tester. Note, that there are examples for both positive and negative temperature coefficients. When setting the computer limits for a positive TC device, the largest difference is subtracted from the upper limit and the smallest difference is subtracted from the lower limit. In the negative coefficient example the largest change is added to the lower limit and the smallest change is added to the upper limit.

**Motorola Zeners**

- Thermal equilibrium specifications:  
 $V_Z$  at 10 mA, 9 V minimum, 11 V maximum:  
 (Positive TC)

TE	Pulsed	Difference
9.53 V	9.45 V	-0.08 V
9.35 V	9.38 V	-0.07 V
9.46 V	9.83 V	-0.08 V
9.56 V	9.49 V	-0.07 V
9.50 V	9.40 V	-0.10 V

Computer test limits:

Set  $V_Z$  max. limit at  $11\text{ V} - 0.10\text{ V} = 10.9\text{ V}$   
 Set  $V_Z$  min. limit at  $9\text{ V} - 0.07\text{ V} = 8.93\text{ V}$

- Thermal equilibrium specifications:  
 $V_Z$  at 10 mA, 2.7 V minimum, 3.3 V maximum:  
 (Negative TC)

TE	Pulsed	Difference
2.78 V	2.83 V	+0.05 V
2.84 V	2.91 V	+0.07 V
2.78 V	2.84 V	+0.05 V
2.86 V	2.93 V	+0.07 V
2.82 V	2.87 V	+0.05 V

Computer test limits:

Set  $V_Z$  min. limit at  $2.7\text{ V} + 0.07\text{ V} = 2.77\text{ V}$   
 Set  $V_Z$  max. limit at  $3.3\text{ V} + 0.05\text{ V} = 3.35\text{ V}$



**1****Alphanumeric Index  
of Part Numbers****2****Cross Reference  
and Index****3****Selector Guide for Transient Voltage  
Suppressors and Zener Diodes****4****Transient Voltage Suppressors  
Axial Leaded Data Sheets****5****Transient Voltage Suppressors  
Surface Mounted Data Sheets****6****Zener Voltage Regulator Diodes  
Axial Leaded Data Sheets****7****Zener Voltage Regulator Diodes  
Surface Mounted Data Sheets****8****Zener Voltage Reference Diodes  
Data Sheets****9****Current Regulator Diodes  
Data Sheets****10****Surface Mount Information  
and Packaging Specifications****11****Technical Information,  
Application Notes and Articles**





**MOTOROLA**

**Literature Distribution Centers:**

USA: Motorola Literature Distribution; P.O. Box 20912; Phoenix, Arizona 85036.

EUROPE: Motorola Ltd.; European Literature Centre; 88 Tanners Drive, Blakelands, Milton Keynes, MK14 5BP, England.

JAPAN: Nippon Motorola Ltd.; 4-32-1, Nishi-Gotanda, Shinagawa-ku, Tokyo 141, Japan.

ASIA PACIFIC: Motorola Semiconductors H.K. Ltd.; Silicon Harbour Center, No. 2 Dai King Street, Tai Po Industrial Estate, Tai Po, N.T., Hong Kong.

